

# Dell PowerEdge T160

## Installation and Service Manual

## Notes, cautions, and warnings

 **NOTE:** A NOTE indicates important information that helps you make better use of your product.

 **CAUTION:** A CAUTION indicates either potential damage to hardware or loss of data and tells you how to avoid the problem.

 **WARNING:** A WARNING indicates a potential for property damage, personal injury, or death.

<b>Chapter 1: About this document.....</b>	<b>6</b>
<b>Chapter 2: Dell PowerEdge T160 system overview.....</b>	<b>7</b>
Front view of the system.....	8
Rear view of the system.....	9
Inside the system .....	11
Locating the Express Service Code and Service Tag.....	12
System information Booklet.....	12
<b>Chapter 3: Technical specifications.....</b>	<b>15</b>
Chassis dimensions.....	15
System weight.....	16
Processor specifications.....	16
Power Supply Units.....	16
Cooling fan specifications.....	17
Supported operating systems.....	17
System battery specifications.....	18
Expansion card riser specifications.....	18
Memory specifications.....	18
Storage controller specifications.....	18
Drives.....	19
Ports and connectors specifications.....	19
NIC port specifications.....	19
Serial connector specifications.....	19
Ports specifications.....	19
Video specifications.....	20
Environmental specifications.....	21
Particulate and gaseous contamination specifications.....	22
Thermal air restrictions.....	23
Thermal restriction matrix.....	23
<b>Chapter 4: Initial system setup and configuration.....</b>	<b>25</b>
Setting up the system.....	25
iDRAC configuration.....	25
Options to set up iDRAC IP address.....	25
Options to log in to iDRAC.....	25
Resources to install operating system.....	26
Options to download drivers and firmware .....	26
Options to download and install OS drivers .....	27
Downloading drivers and firmware.....	27
<b>Chapter 5: Pre-operating system management applications.....</b>	<b>28</b>
System Setup.....	28
System BIOS.....	29

iDRAC Settings.....	44
Device Settings.....	44
Service Tag Settings.....	44
Dell Lifecycle Controller.....	44
Embedded system management.....	44
Boot Manager.....	44
PXE boot.....	45
<b>Chapter 6: Minimum to POST .....</b>	<b>46</b>
Minimum configuration to POST .....	46
Configuration validation.....	46
Error messages.....	47
<b>Chapter 7: Disassembly and reassembly.....</b>	<b>48</b>
Safety instructions.....	48
Before working inside your system .....	48
After working inside your system.....	49
Recommended tools.....	49
System cover.....	49
Removing the system cover.....	49
Installing the system cover.....	50
Air shroud.....	52
Removing the air shroud.....	52
Installing the air shroud.....	52
Intrusion switch.....	53
Removing the intrusion switch module.....	53
Installing the intrusion switch module.....	54
Drives.....	55
Removing the drive from the drive cage.....	55
Installing the drive carrier.....	57
Removing the drive from the drive carrier.....	59
Installing the drive into the drive carrier.....	60
Cooling fans.....	61
Removing the cooling fan.....	61
Installing the cooling fan.....	63
Cable routing.....	65
System memory.....	68
System memory guidelines.....	68
General memory module installation guidelines.....	69
Removing a memory module.....	70
Installing a memory module.....	71
Processor and heat sink module.....	72
Removing the heat sink.....	72
Removing the processor.....	73
Installing the processor.....	74
Installing the heat sink.....	75
Expansion cards and expansion card risers.....	76
Expansion card installation guidelines.....	76
Removing an expansion card.....	78

Installing an expansion card.....	79
Optional BOSS-N1 module.....	81
Removing the BOSS-N1 module.....	81
Installing the BOSS-N1 module.....	82
Removing the BOSS-N1 card carrier.....	84
Installing the BOSS-N1 card carrier.....	85
Power supply unit.....	87
Removing the cabled PSU.....	87
Installing the cabled PSU.....	88
System battery .....	89
Replacing the system battery.....	89
System board.....	91
Removing the system board.....	91
Installing the system board.....	93
Restoring the system using Easy Restore.....	96
Manually update the Service Tag.....	96
Trusted Platform Module.....	96
Upgrading the Trusted Platform Module.....	96
Initializing TPM for users.....	97
Initializing the TPM 2.0 for users.....	98
Control panel.....	98
Removing the control panel assembly.....	98
Installing the control panel assembly.....	100
<b>Chapter 8: Upgrade Kits.....</b>	<b>102</b>
BOSS-N1 module kit.....	102
<b>Chapter 9: Jumpers and connectors.....</b>	<b>104</b>
System board layout.....	104
System board jumper settings.....	105
Disabling a forgotten password.....	106
<b>Chapter 10: System diagnostics and indicator codes.....</b>	<b>107</b>
System ID indicator.....	107
iDRAC Direct LED indicator codes.....	107
NIC indicator codes.....	108
Non-redundant cabled power supply unit indicator codes.....	109
Using system diagnostics.....	109
Dell Embedded System Diagnostics.....	109
<b>Chapter 11: Getting help.....</b>	<b>111</b>
Recycling or End-of-Life service information.....	111
Contacting Dell Technologies.....	111
Accessing system information by using QR code.....	111
QR code for PowerEdge T160 system resources.....	112
Receiving automated support with Secure Connect Gateway (SCG).....	112
<b>Chapter 12: Documentation resources.....</b>	<b>113</b>

# About this document

This document provides an overview about the system, information about installing and replacing components, diagnostic tools, and guidelines to be followed while installing certain components.

# Dell PowerEdge T160 system overview

The PowerEdge T160 system is a single-socket 3U tower server that supports:

- One Intel® Xeon® E-2400 series processor with up to eight cores or Intel® Pentium® G7400/G7400T processor with up to two cores
- Four ECC UDIMM slots
- One Cabled AC power supply unit
- Up to 3 x 3.5-inch cable SATA HDD/SSD from chipset
- Up to 3 x 3.5-inch cable SAS/SATA HDD/SSD from PERC
- Up to 3 x 3.5-inch + 2 x 2.5-inch cable SATA HDD/SSD from chipset
- Up to 3 x 3.5-inch + 2 x 2.5-inch cable SAS/SATA HDD/SSD drives from PERC

 **NOTE:** All instances of SAS and SATA drives are referred to as drives in this document, unless specified otherwise.

 **NOTE:** The Dell PowerEdge T160 system supports speeds of 12 Gbps for SAS3 and 6 Gbps for SATA. The drive speed is determined by the controller's capability.

 **CAUTION:** Do not install GPUs, network cards, or other PCIe devices on your system that are not validated and tested by Dell. Damage caused by unauthorized and invalidated hardware installation will null and void the system warranty.

## Topics:





- [Front view of the system](#)
- [Rear view of the system](#)
- [Inside the system](#)
- [Locating the Express Service Code and Service Tag](#)
- [System information Booklet](#)

# Front view of the system



Figure 1. Front view of the system

Table 1. Features available on the front of the system

Item	Ports, panels, and slots	Icon	Description
1	Power button		Indicates if the system is powered on or off. Press the power button to manually power on or off the system.
2	Status LED indicators		Indicates the status of the system. For more information, see the Status LED indicators section.
3	USB 3.2 port		Supports USB 3.2 compliant devices.
4	iDRAC Direct (Micro-AB USB) port		The iDRAC Direct (Micro-AB USB) port enables you to access the iDRAC direct Micro-AB USB features. For more information, see



**Table 1. Features available on the front of the system (continued)**





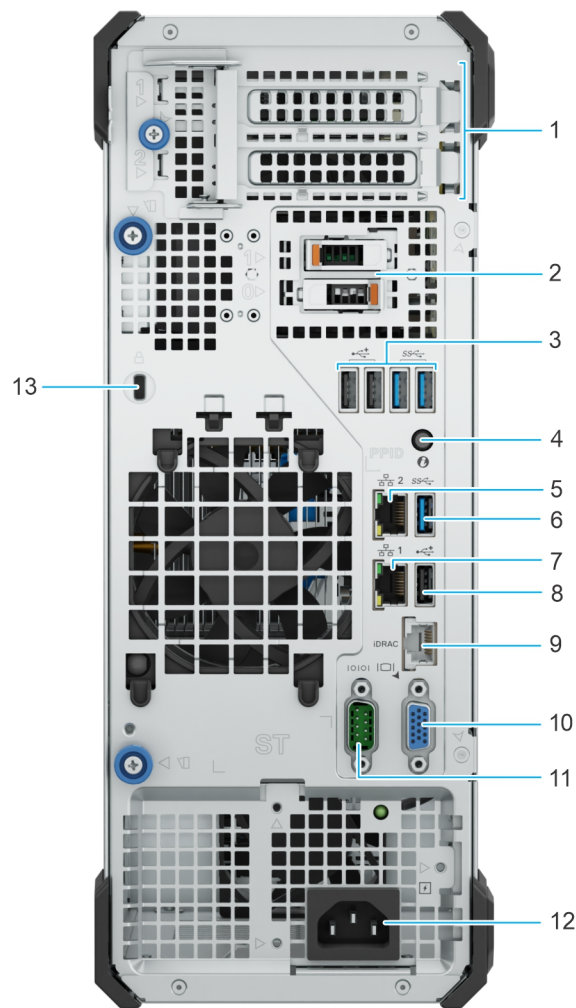



Item	Ports, panels, and slots	Icon	Description
			the <i>Integrated Dell Remote Access Controller User's Guide</i> at <a href="#">PowerEdge Manuals</a> .
5	Express Service Tag	N/A	A slide-out label panel that contains the Express Service Tag that has system information such as Service Tag, NIC, MAC address, and so on. If you have opted for the secure default access to iDRAC, the Information tag will also contain the iDRAC secure default password.
6	Rubber feet	N/A	Rubber feet

## Rear view of the system

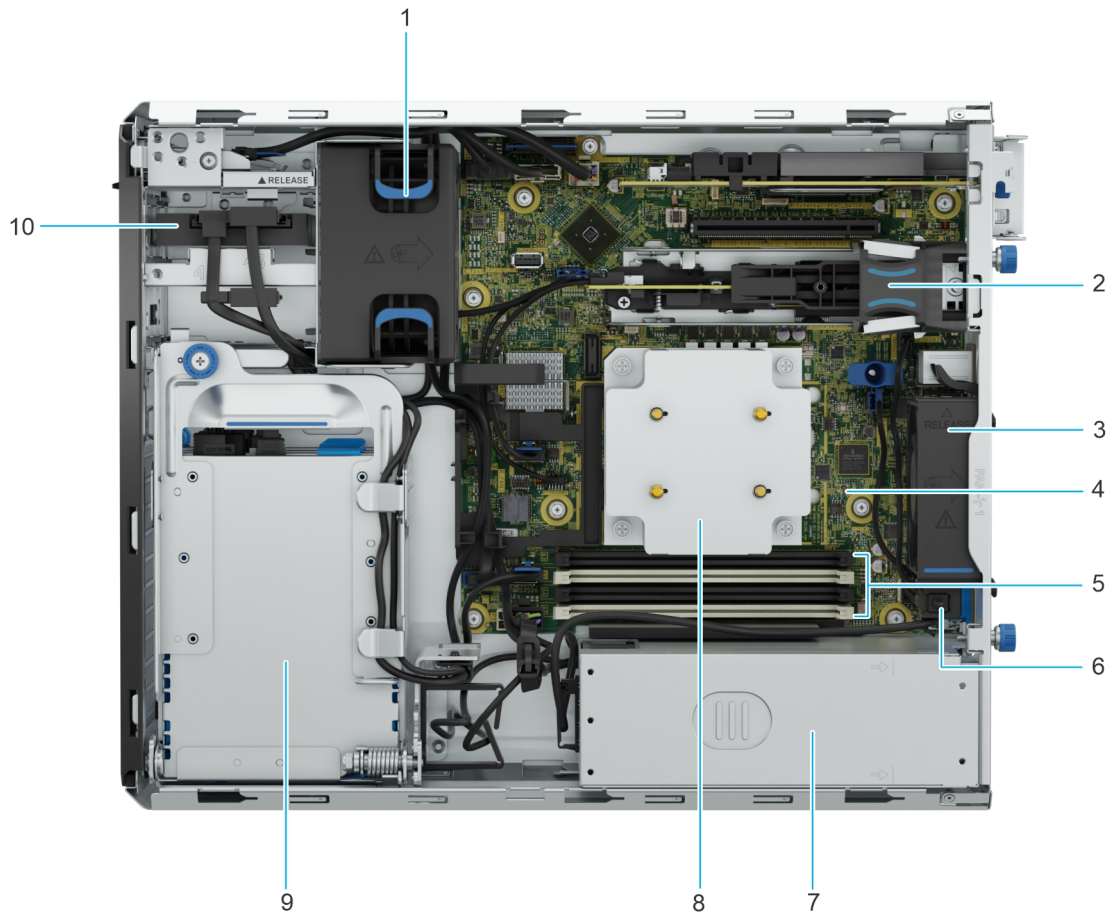

**Figure 2. Rear view of the system**

**Table 2. Features available at the rear of the system**

Item	Ports, panels, or slots	Icon	Description
1	PCIe expansion card slots	N/A	Enables you to connect PCI express expansion cards.
2	BOSS-N1 (optional)	N/A	BOSS-N1 (optional) for internal system boot.
3	2 x USB 2.0 + 2 x USB 3.2 ports		Supports USB 2.0 and USB 3.2 compliant devices.
4	System Identification (ID) button		The System Identification (ID) button is available at the rear of the system. Press the button to identify a system by turning on the system ID button. You can also use the system ID button to reset iDRAC and to access the BIOS using the step-through mode. When pressed, the system ID LED in the back panel blinks until either the front or rear button is pressed again. Press the button to toggle between on or off mode.
5	NIC port (2)		The NIC ports that are integrated on the LOM card provide network connectivity which is connected to the system board.
6	USB 3.2 port		Supports USB 3.2 compliant devices.
7	NIC port (1)		The NIC ports that are integrated on the LOM card provide network connectivity which is connected to the system board.
8	USB 2.0 port		Supports USB 2.0 compliant devices.
9	Dedicated iDRAC Ethernet port	<b>iDRAC</b>	Enables you to remotely access iDRAC. For more information, see the Integrated Dell Remote Access Controller User's Guide at <a href="#">PowerEdge Manuals</a> .
10	VGA port		Enables you to connect a display device to the system.
11	Serial port		Enables you to connect a serial device to the system.
12	Cabled power supply unit		Enables you to connect to AC power source.
13	Kensington lock slot	N/A	Enables you to connect security cable to prevent unauthorized movement of your system.

# Inside the system



**Figure 3. Inside view of the system**

- |  |                         |
|--|-------------------------|
| 1. High Performance (HPR) fan - Optional | 2. BOSS N1 module       |
| 3. Cooling fan                           | 4. System board         |
| 5. Memory module sockets                 | 6. Intrusion switch     |
| 7. Cabled PSU                            | 8. Heat sink            |
| 9. 3.5-inch drive cage                   | 10. 2.5-inch drive cage |

# Locating the Express Service Code and Service Tag

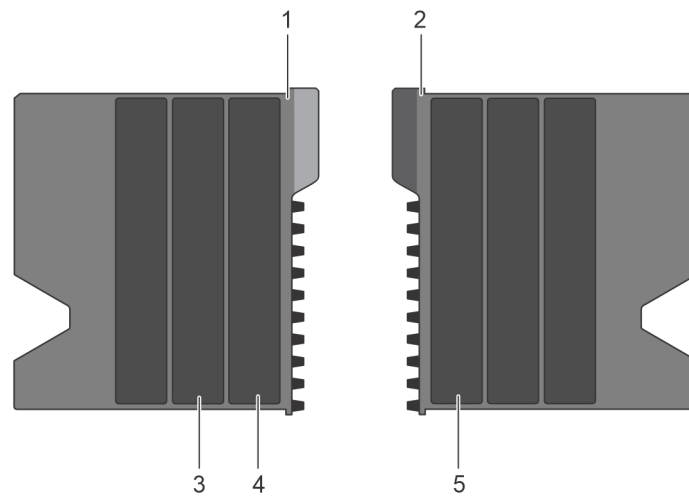

Figure 4. Locating the Express Service Code and Service tag

1. Express Service Tag (top view)
2. Express Service Tag (bottom view)
3. Express Service Tag label
4. CFI address label or SigSaly label
5. iDRAC MAC address and iDRAC secure password label

## System information Booklet





The system information booklet is located on the air shroud.

### Service Information

#### System Touchpoints

- Hot swap touchpoints: Components with terracotta touchpoints can be serviced while the system is running.
- Cold swap touchpoints: Components with blue touchpoints require a full system shutdown before servicing.

#### Icon Legend

 iDRAC Direct (Micro-AB USB)	 Memory Bank
 System ID	 Power Supply

**⚠ Caution:** Many repairs may only be done by a certified service technician. You should only perform troubleshooting and simple repairs as authorized in your product documentation, or as directed by the online or telephone service and support team. Damage due to servicing that is not authorized by Dell is not covered by your warranty. Read and follow the safety instructions that came with the product.

To learn more about this Dell product or to order additional or replacement parts, go to [Dell.com/support](https://Dell.com/support)

Figure 5. Service information

## Memory Information

**⚠ Caution:** Memory (DIMMs) and CPU may be hot during servicing.

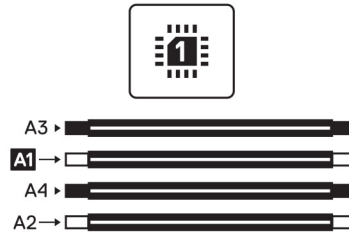

### Memory Population

Configuration	Sequence
Memory-Optimized	1, 2, 3, 4

\*Latest population rules are documented in the *Installation and Service Manual*.

Figure 6. Memory information

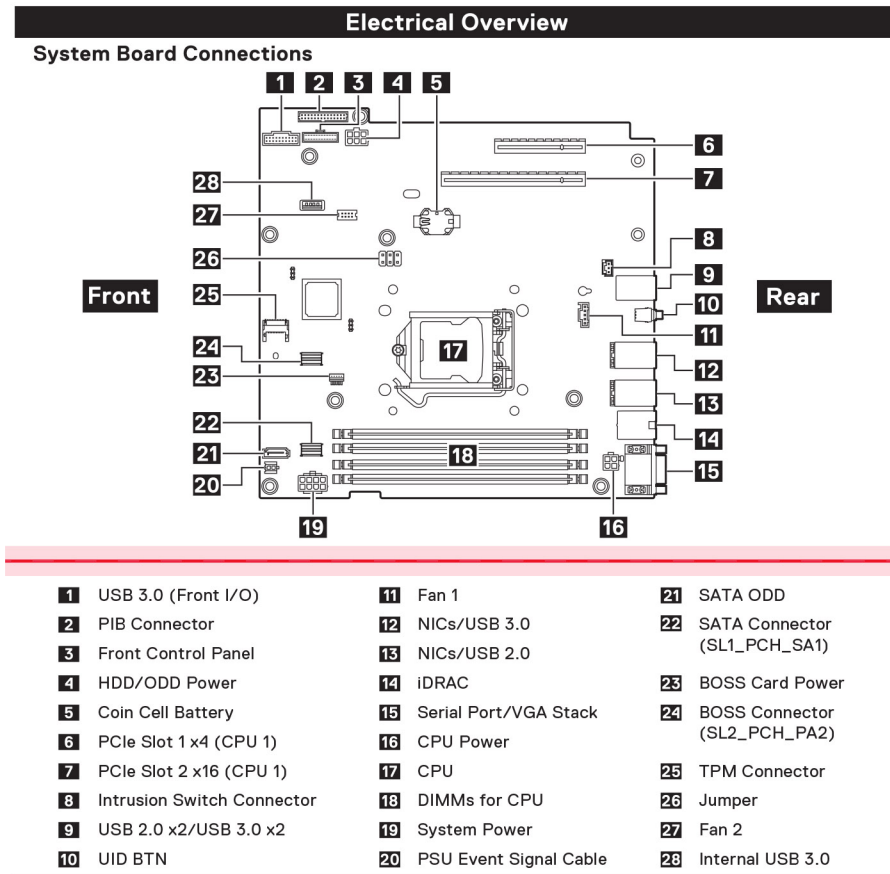

#### 4 Jumper Settings

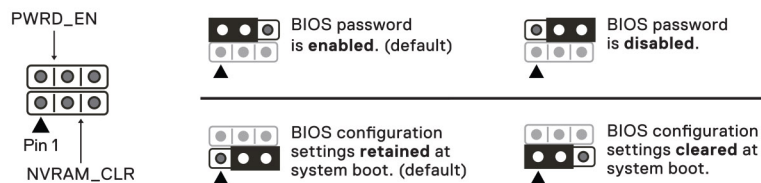
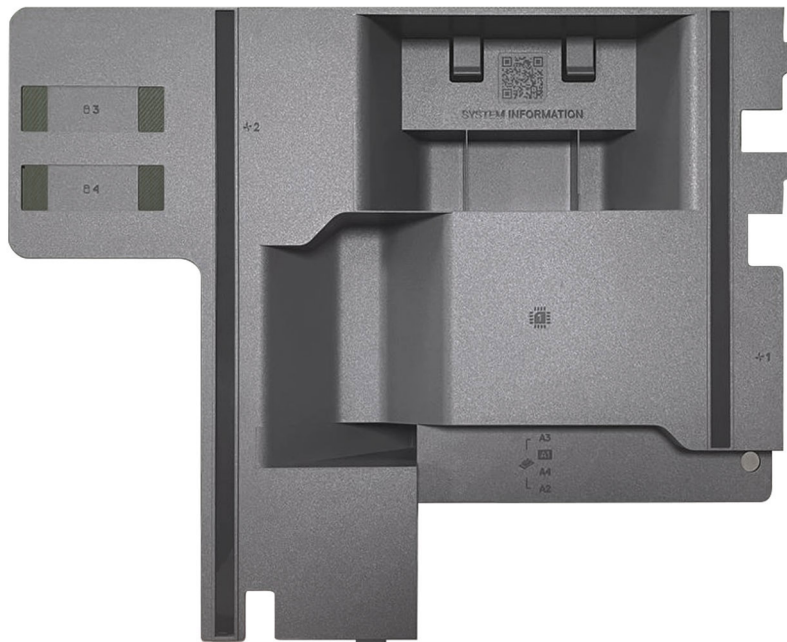

Figure 7. Electrical overview

**NOTE:** If the SIB is missing, please scan the QR code on the air shroud for SIB contents.



**Figure 8. Air Shroud with SIB**



**Figure 9. QR Code on the Air Shroud**

## Technical specifications

The technical and environmental specifications of your system are outlined in this section.

### Topics:

- Chassis dimensions
- System weight
- Processor specifications
- Power Supply Units
- Cooling fan specifications
- Supported operating systems
- System battery specifications
- Expansion card riser specifications
- Memory specifications
- Storage controller specifications
- Drives
- Ports and connectors specifications
- Video specifications
- Environmental specifications

## Chassis dimensions

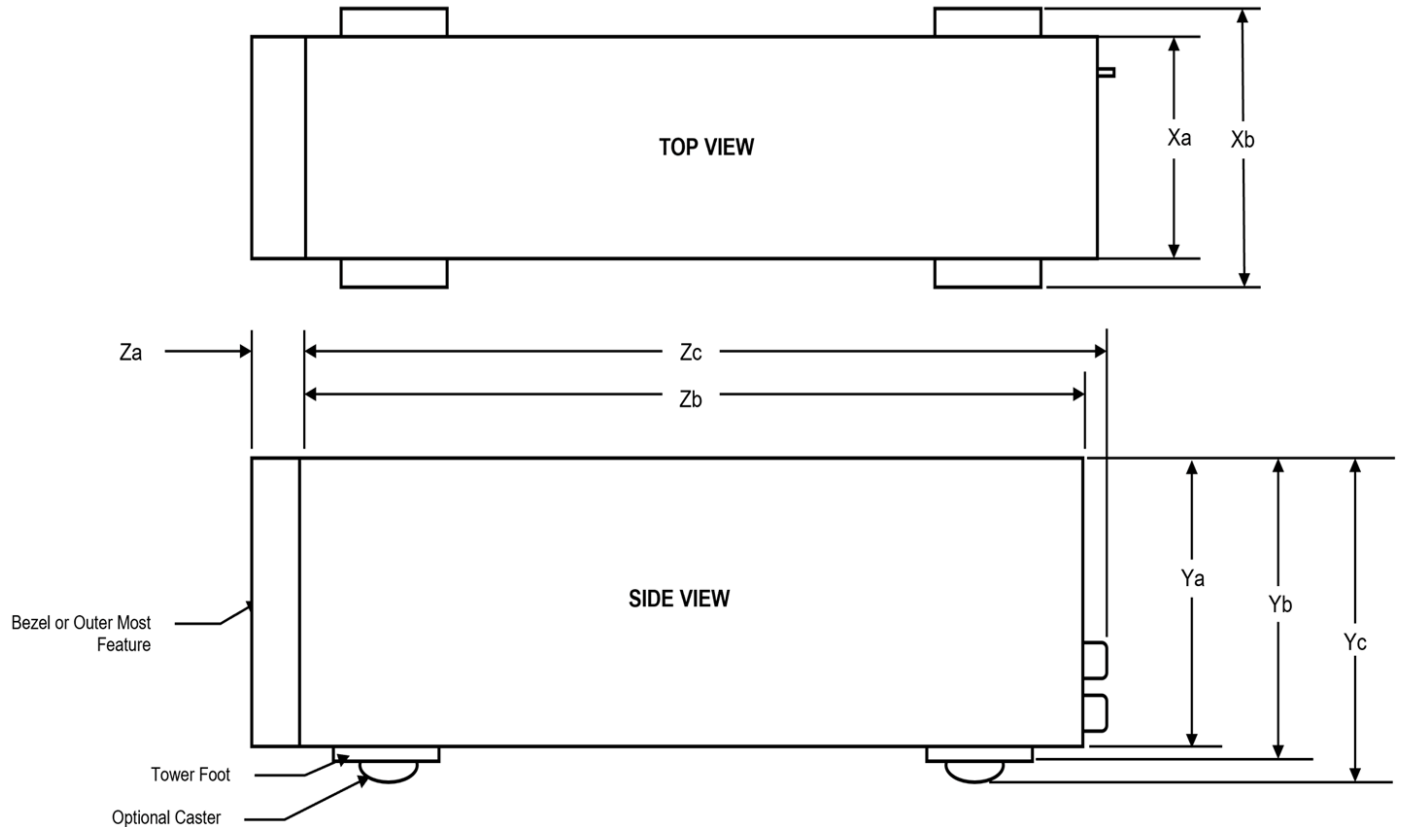

Figure 10. Chassis dimensions

**Table 3. Chassis dimension for the system**

Drives	Xa	Xb	Ya	Yb	Yc	Za (with bezel)	Za (without bezel)	Zb	Zc
3 x 3.5-inch + 2 x 2.5-inch cable SAS/SATA HDD/SSD drives from PERC	125.0 mm (4.92 inches)	132.52 mm (5.21 inches)	329.5 mm (12.97 inches)	332.5 mm (13.09 inches)	N/A	5 mm (0.19 inches)	N/A	403.8 mm (15.89 inches)	420.55 mm (16.55 inches)

## System weight

**Table 4. PowerEdge T160 system weight**

System configuration	Maximum weight (with all drives/SSDs)
A server with fully populated drives	11.64 kg (25.66 lbs)
A server without drives and PSU installed	6.31 kg (13.91 lbs)

## Processor specifications

**Table 5. PowerEdge T160 processor specifications**

Supported processor	Number of processors supported
Intel® Xeon® E-2400 series processor	One
Intel® Pentium® G7400/G7400T processor	One

## Power Supply Units

The PowerEdge T160 system supports one AC cabled power supply unit (PSU).

**Table 6. PSU specifications**

PSU	Class	Heat dissipation (maximum)	Frequency	Voltage	AC		DC	Current
					High line 200–240 V	Low line 100–120 V		
300 W	Bronze	1250 BTU/hr	50/60 Hz	100 V–240 V AC	300 W	300 W	N/A	4.6 A - 2.3 A
500 W	Platinum	1920 BTU/hr	50/60 Hz	100 V–240 V AC	500 W	500 W	N/A	7.0 A - 3.5 A

**NOTE:** This system is also designed to connect to the IT power systems with a phase-to-phase voltage not exceeding 240 V.

**NOTE:** Heat dissipation is calculated using the PSU wattage rating.

**NOTE:** When selecting or upgrading the system configuration, to ensure optimum power utilization, verify the system power consumption with the Dell Energy Smart Solution Advisor available at [Dell.com/ESSA](https://www.dell.com/ESSA).



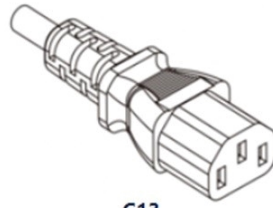

C13

Figure 11. PSU power cord

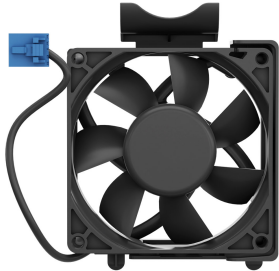

Table 7. PSU power cords

Form factor	Output	Power cord
Cable PSU 120 mm	300 W AC	C13/C14
	500 W AC	

## Cooling fan specifications

The Dell PowerEdge T160 system supports up to one standard (STD) and one High-Performance PCIe (HPR/ PCIe) cooling fan.

Table 8. Cooling fan specifications

Fan type	Abbreviation	Also known as	Label color	Label image
<b>Standard fan</b>	STD	STD - Standard	N/A	
<b>High Performance (HPR) fan/ PCIe</b>	HPR (PCIe)	HPR - High Performance/ PCIe	N/A	

## Supported operating systems

The PowerEdge T160 system supports the following operating systems:

- Canonical Ubuntu Server LTS
- Microsoft Windows Server with Hyper-V
- Red Hat Enterprise Linux
- SUSE Linux Enterprise Server

- VMware ESXi

For more information, go to [OS support](#).

## System battery specifications

The PowerEdge T160 system uses one CR 2032 3.0-V lithium coin cell battery.

## Expansion card riser specifications

The PowerEdge T160 system supports up to two PCIe slots on the system board.

**Table 9. Expansion card slots supported on the system board**

PCIe slot	Expansion card riser	Processor connection	Height	Length	Slot width	
					Electrical	Mechanical
Slot 1 (Gen4)	N/A	Processor	Half Height	Half Length	x4	x8
Slot 2 (Gen4)	N/A	Processor	Half Height	Half Length	x16	x16

## Memory specifications

The PowerEdge T160 system supports the following memory specifications for optimized operation.

**Table 10. Memory specifications**

DIMM type	DIMM rank	DIMM capacity	Single processor	
			Minimum system capacity	Maximum system capacity
DDR5 ECC UDIMM	Single rank	16 GB	16 GB	64 GB
	Dual rank	32 GB	32 GB	128 GB

**Table 11. Memory module sockets**

Memory module sockets	Speed
4, 288-pin	Up to 4400 MT/s

**NOTE:** Memory DIMM slots are not hot pluggable.

**NOTE:** The processor may reduce the performance of the rated DIMM speed. For more information, refer T160 Technical Guide at [PowerEdge Manuals](#).

## Storage controller specifications

The PowerEdge T160 system supports the following controller cards:

**Table 12. Storage controller cards**

Supported storage controller cards
Internal controllers <ul style="list-style-type: none"> <li>• PERC H355 Adapter</li> <li>• PERC H755 Adapter</li> </ul>

**Table 12. Storage controller cards (continued)**

Supported storage controller cards
<ul style="list-style-type: none"> <li>• HBA355i Adapter</li> </ul>
External controllers <ul style="list-style-type: none"> <li>• HBA355e Adapter</li> </ul>
Internal Boot <ul style="list-style-type: none"> <li>• Boot Optimized Storage Subsystem (BOSS-N1): HWRAID 2 x M.2 SSDs</li> </ul>
Software RAID <ul style="list-style-type: none"> <li>• S160</li> </ul>

## Drives

The PowerEdge T160 system supports:

- Up to 3 x 3.5-inch cable SATA HDD/SSD from chipset
- Up to 3 x 3.5-inch cable SAS/SATA HDD/SSD from PERC
- Up to 3 x 3.5-inch + 2 x 2.5-inch cable SATA HDD/SSD from chipset
- Up to 3 x 3.5-inch + 2 x 2.5-inch cable SAS/SATA HDD/SSD drives from PERC

## Ports and connectors specifications

### NIC port specifications

The PowerEdge T160 system supports up to two 10/100/1000 Mbps Network Interface Controller (NIC) ports embedded on the LAN on Motherboard (LOM).

**Table 13. NIC port specification for the system**

Feature	Specifications
LOM on Planar	2 x 1 GbE
Network Card	1 GbE x 4, 10 GbE x 2, 10 GbE x 4

### Serial connector specifications

The PowerEdge T160 system supports one serial port on the system board, which is Data Terminal Equipment (DTE), 16550-compliant .

The serial connector is installed as default on the system board.

## Ports specifications

**Table 14. PowerEdge T160 port specifications**

Front		Rear		Internal	
Port type	No. of ports	Port type	No. of ports	Port type	No. of ports
USB 3.2 Gen1	One	USB 2.0	Three	USB 3.2 Gen1	One
iDRAC Direct (Micro-AB USB) port	One	USB 3.2 Gen1	Three		

 **NOTE:** The micro USB 2.0 compliant port can only be used as an iDRAC Direct or a management port.

## Video specifications

The PowerEdge T160 system supports integrated Matrox G200eW graphics controller with 16 MB of video frame buffer.

**Table 15. Supported video resolution options**

Resolution	Refresh rate (Hz)	Color depth (bits)
640 x 480	60 Hz	32
640 x 480	72 Hz	32
640 x 480	75 Hz	32
640 x 480	85 Hz	32
800 x 600	60 Hz	32
800 x 600	72 Hz	32
800 x 600	75 Hz	32
800 x 600	85 Hz	32
1024 x 768	60 Hz	32
1024 x 768	72 Hz	32
1024 x 768	75 Hz	32
1024 x 768	85 Hz	32
1280 x 800	60 Hz	32
1280 x 800	75 Hz	32
1280 x 1024	60 Hz	32
1280 x 1024	75 Hz	32
1360 x 768	60 Hz	32
1440 x 900	60 Hz	32
1440 x 900	60 Hz (RB)	32
1600 x 900	60 Hz (RB)	32
1600 x 900	60 Hz (RB)	32
1600 x 1200	60 Hz	32
1600 x 1200	60 Hz (RB)	32
1680 x 1050	60 Hz (RB)	32
1680 x 1050	60 Hz	32
1920 x 1080	60 Hz	32
1920 x 1080	60 Hz (RB)	32
1920 x 1200	60 Hz	32
1920 x 1200	60 Hz (RB)	32

# Environmental specifications

**i** **NOTE:** For additional information about environmental certifications, refer to the *Product Environmental Datasheet* located with the *Documentation* on [support](#).

**Table 16. Continuous Operation Specifications for ASHRAE A2**

Temperature	Allowable continuous operations
Temperature range for altitudes <= 900 m (<= 2953 ft)	10–35°C (50–95°F) with no direct sunlight on the equipment
Humidity percent range (non-condensing at all times)	8% RH with -12°C minimum dew point to 80% RH with 21°C (69.8°F) maximum dew point
Operational altitude de-rating	Maximum temperature is reduced by 1°C/300 m (33.8°F/984 Ft) above 900 m (2953 Ft).

**Table 17. Continuous Operation Specifications for ASHRAE A3**

Temperature	Allowable continuous operations
Temperature range for altitudes <= 900 m (<= 2953 ft)	5–40°C (41–104°F) with no direct sunlight on the equipment
Humidity percent range (non-condensing at all times)	8% RH with -12°C minimum dew point to 85% RH with 24°C (75.2°F) maximum dew point
Operational altitude de-rating	Maximum temperature is reduced by 1°C/175 m (33.8°F/574 Ft) above 900 m (2953 Ft).

**Table 18. Continuous Operation Specifications for ASHRAE A4**

Temperature	Allowable continuous operations
Temperature range for altitudes <= 900 m (<= 2953 ft)	5–45°C (41–113°F) with no direct sunlight on the equipment
Humidity percent range (non-condensing at all times)	8% RH with -12°C minimum dew point to 90% RH with 24°C (75.2°F) maximum dew point
Operational altitude de-rating	Maximum temperature is reduced by 1°C/125 m (33.8°F/410 Ft) above 900 m (2953 Ft).

**Table 19. Continuous Operation Specifications for Rugged Environment**

Temperature	Allowable continuous operations
Temperature range for altitudes <= 900 m (<= 2953 ft)	5–55°C (41–131°F) with no direct sunlight on the equipment
Humidity percent range (non-condensing at all times)	8% RH with -12°C minimum dew point to 90% RH with 24°C (75.2°F) maximum dew point
Operational altitude de-rating	Maximum temperature is reduced by 1°C/125 m (33.8°F/410 Ft) above 900 m (2953 Ft).

**Table 20. Common Environmental Specifications for ASHRAE A2, A3, A4, and Rugged**

Allowable continuous operations	
Maximum temperature gradient (applies to both operation and non-operation).	20°C in an hour* (36°F in an hour) and 5°C in 15 minutes (41°F in 15 minutes), 5°C in an hour* (41°F in an hour) for tape <b>i</b> <b>NOTE:</b> * - Per ASHRAE thermal guidelines for tape hardware, these are not instantaneous rates of temperature change.
Non-operational temperature limits	-40 to 65°C (-40 to 149°F)
Non-operational humidity limits	5% to 95% RH with 27°C (80.6°F) maximum dew point

**Table 20. Common Environmental Specifications for ASHRAE A2, A3, A4, and Rugged (continued)**

Allowable continuous operations	
Maximum non-operational altitude	12,000 meters (39,370 ft)
Maximum operational altitude	3,048 meters (10,000 ft)

**Table 21. Maximum vibration specifications**

Maximum vibration	Specifications
Operating	0.26 G <sub>rms</sub> at 5 Hz to 350 Hz (all operation orientations)
Storage	1.88 G <sub>rms</sub> at 10 Hz to 500 Hz for 15 minutes (all six sides tested)

**Table 22. Maximum shock pulse specifications**

Maximum shock pulse	Specifications
Operating	Six consecutively executed shock pulses in the positive and negative x, y, and z axis of 6 G for up to 11 ms.
Storage	Six consecutively executed shock pulses in the positive and negative x, y, and z axis (one pulse on each side of the system) of 71 G for up to 2 ms.

## Particulate and gaseous contamination specifications

The following table defines the limitations that help avoid any equipment damage or failure from particulates and gaseous contamination. If the levels of particulates or gaseous pollution exceed the specified limitations and result in equipment damage or failure, you must rectify the environmental conditions. Remediation of environmental conditions is the responsibility of the customer.

**Table 23. Particulate contamination specifications**

Particulate contamination	Specifications
Air filtration: Conventional Data Center only	<p>Data center air filtration as defined by ISO Class 8 per ISO 14644-1 with a 95% upper confidence limit</p> <ul style="list-style-type: none"> <li><b>i</b> <b>NOTE:</b> Filtering room air with a MERV8 filter, as specified in ANSI/ASHRAE Standard 127, is a recommended method for achieving the necessary environmental conditions.</li> <li><b>i</b> <b>NOTE:</b> Air entering the data center must have MERV11 or MERV13 filtration.</li> <li><b>i</b> <b>NOTE:</b> This condition applies to data center environments only. Air filtration requirements do not apply to IT equipment designed to be used outside a data center, in environments such as an office or factory floor.</li> </ul>
Walk-Up Edge Data Center or Cabinet (sealed, closed loop environment)	<p>Filtration is not required for cabinets that are anticipated to be opened six times or less per year. Class 8 per ISO 1466-1 filtration as defined above is required otherwise.</p> <ul style="list-style-type: none"> <li><b>i</b> <b>NOTE:</b> In environments commonly above ISA-71 Class G1 or that may have known challenges, special filters may be required.</li> </ul>
Conductive dust: data center and non-data center environments	<p>Air must be free of conductive dust, zinc whiskers, or other conductive particles.</p> <ul style="list-style-type: none"> <li><b>i</b> <b>NOTE:</b> Conductive dust, which can interfere with equipment operation, can originate from various sources, including manufacturing processes and zinc whiskers that may develop on the plating of raised floor tiles.</li> <li><b>i</b> <b>NOTE:</b> This condition applies to data center and non-data center environments.</li> </ul>

**Table 23. Particulate contamination specifications (continued)**

Particulate contamination	Specifications
Corrosive dust: data center and non-data center environments	<ul style="list-style-type: none"> <li>Air must be free of corrosive dust.</li> <li>Residual dust present in the air must have a deliquescent point less than 60% relative humidity.</li> </ul> <p><b>NOTE:</b> This condition applies to data center and non-data center environments.</p>

**Table 24. Gaseous contamination specifications**

Gaseous contamination	Specifications	Notes
Copper coupon corrosion rate	ISA-71 Class G1: <300 Å/month	Per ANSI/ISA71.04
Silver coupon corrosion rate	ISA-71 Class G1: <200 Å/month	Per ANSI/ISA71.04

## Thermal air restrictions

### ASHRAE A3/A4 environment

- BOSS-N1 is not supported
- Non-Dell qualified peripheral cards and /or peripheral cards greater than 25 W are not supported

## Thermal restriction matrix

**Table 25. Label reference**

Label	Description
STD	Standard
HPR	High performance
HSK	Heat sink

**Table 26. Thermal restriction matrix**

-	TDP	Number of Cores	3x 3.5 inch Chip SATA	3x 3.5 inch PERC SAS/SATA	3x 3.5 inch + 2x 2.5 inch Chip SATA	3x 3.5 inch + 2x 2.5 inch PERC SAS/SATA
			HSK/FAN type	HSK/FAN type	HSK/FAN type	HSK/FAN type
CPU TDP	95 W	8	HPR/STD	HPR/STD and HPR (PCle)	HPR/STD and HPR (PCle)	HPR/STD and HPR (PCle)
	95 W	6	HPR/STD	HPR/STD and HPR (PCle)	HPR/STD and HPR (PCle)	HPR/STD and HPR (PCle)
	80 W	8	STD/STD	STD/STD and HPR (PCle)	STD/STD and HPR (PCle)	STD/STD and HPR (PCle)
	80 W	6	STD/STD	STD/STD and HPR (PCle)	STD/STD and HPR (PCle)	STD/STD and HPR (PCle)
	65 W	8	STD/STD	STD/STD and HPR (PCle)	STD/STD and HPR (PCle)	STD/STD and HPR (PCle)
	65 W	6	STD/STD	STD/STD and HPR (PCle)	STD/STD and HPR (PCle)	STD/STD and HPR (PCle)
	55 W	4	STD/STD	STD/STD and HPR (PCle)	STD/STD and HPR (PCle)	STD/STD and HPR (PCle)

**Table 26. Thermal restriction matrix (continued)**

-	TDP	Number of Cores	3x 3.5 inch Chip SATA	3x 3.5 inch PERC SAS/SATA	3x 3.5 inch + 2x 2.5 inch Chip SATA	3x 3.5 inch + 2x 2.5 inch PERC SAS/SATA
			HSK/FAN type	HSK/FAN type	HSK/FAN type	HSK/FAN type
	46 W	2	STD/STD	STD/STD and HPR (PCIe)	STD/STD and HPR (PCIe)	STD/STD and HPR (PCIe)
	35 W	2	STD/STD	STD/STD and HPR (PCIe)	STD/STD and HPR (PCIe)	STD/STD and HPR (PCIe)

**i** **NOTE:** If a BOSS or a PCIe card is installed or a 2.5 inch drive is installed in the 2.5 inch drive bay, an HPR PCI fan is needed for all the configurations.



# Initial system setup and configuration

This section describes the tasks for initial setup and configuration of the Dell system. The section also provides general steps to set up the system and the reference guides for detailed information.

## Topics:

- [Setting up the system](#)
- [iDRAC configuration](#)
- [Resources to install operating system](#)

## Setting up the system

Perform the following steps to set up the system:

### Steps

1. Unpack the system.
2. Connect the peripherals to the system and the system to the electrical outlet.
3. Power on the system.

For more information about setting up the system, see the *Getting Started Guide* that is shipped with your system.

**i** **NOTE:** For information about managing the basic settings and features of the system, see the [Pre-operating system management applications](#) chapter.

## iDRAC configuration

The Integrated Dell Remote Access Controller (iDRAC) is designed to make you more productive as a system administrator and improve the overall availability of Dell servers. iDRAC alerts you to system issues, helps you to perform remote management, and reduces the need for physical access to the system.

### Options to set up iDRAC IP address

To enable communication between your system and iDRAC, you must first configure the network settings based on your network infrastructure. The network settings option is set to **DHCP**, by default.

**i** **NOTE:** For static IP configuration, you must request for the settings at the time of purchase.

**i** **NOTE:** To access iDRAC, ensure that you connect the Ethernet cable to the iDRAC dedicated network port or use the iDRAC Direct port by using the micro USB (type AB) cable. You can also access iDRAC through the shared LOM mode, if you have opted for a system that has the shared LOM mode enabled.

### Options to log in to iDRAC

To log in to the iDRAC Web User Interface, open a browser and enter the IP address.

You can log in to iDRAC as:

- iDRAC user
- Microsoft Active Directory user
- Lightweight Directory Access Protocol (LDAP) user

In the login screen displayed, if you have opted for secure default access to iDRAC, the default username is `root` and enter the iDRAC secure default password available on back of the Information Tag. If you opted for legacy password, use the iDRAC legacy username and password - `root` and `calvin`, the iDRAC default password will be blank on the information tag. Then you will be prompted and required to create a password of your choice before proceeding. You can also log in by using your Single Sign-On or Smart Card.

**NOTE:** Ensure that you change the default username and password after setting up the iDRAC IP address.

For more information about logging in to the iDRAC and iDRAC licenses, see the latest [Integrated Dell Remote Access Controller User's Guide](#)

**NOTE:** To determine the most recent iDRAC release for your platform and for latest documentation version, see KB article [KB78115](#).

You can also access iDRAC using command-line protocol - RACADM. For more information, see the [Integrated Dell Remote Access Controller RACADM CLI Guide](#) .

You can also access iDRAC using automation tool - Redfish API. For more information, see the [Integrated Dell Remote Access Controller User's Guide Redfish API Guide](#).

## Resources to install operating system

If the system is shipped without an operating system, you can install a supported operating system by using one of the resources provided in the table below. For information about how to install the operating system, see the documentation links provided in the table below.

**Table 27. Resources to install the operating system**

Resource	Documentation links
iDRAC	<a href="#">Integrated Dell Remote Access Controller User's Guide</a> or for system specific Integrated Dell Remote Access Controller User's Guide, go to <a href="#">PowerEdge Manuals</a> > <b>Product Support</b> page of your system > <b>Documentation</b> . <b>NOTE:</b> To determine the most recent iDRAC release for your platform and for latest documentation version, see KB article at <a href="#">KB78115</a> .
Lifecycle Controller	Dell Lifecycle Controller User's Guide at <a href="#">iDRAC Manuals</a> or for system specific Dell Lifecycle Controller User's Guide , go to <a href="#">PowerEdge Manuals</a> > <b>Product Support</b> page of your system > <b>Documentation</b> . Dell recommends using Lifecycle Controller to install the OS, since all required drivers are installed on the system. <b>NOTE:</b> To determine the most recent iDRAC release for your platform and for latest documentation version, see KB article at <a href="#">KB78115</a> .
OpenManage Deployment Toolkit	<a href="#">OpenManage Manuals</a> > OpenManage Deployment Toolkit
Dell certified VMware ESXi	<a href="#">Virtualization solutions</a>

**NOTE:** For more information about installation and how-to videos for operating systems supported on PowerEdge systems, see [Supported Operating Systems for Dell PowerEdge systems](#).

## Options to download drivers and firmware

You can download the firmware from the Dell support site. For information about downloading firmware, see the [Downloading drivers and firmware](#) section.

You can also choose any one of the following options to download the firmware. For information about how to download the firmware, see the documentation links provided in the table below.

**Table 28. Options to download firmware**

Option	Documentation link
Using Integrated Dell Remote Access Controller Lifecycle Controller (iDRAC with LC)	<a href="#">iDRAC Manuals</a>
Using Dell Repository Manager (DRM)	<a href="#">OpenManage Manuals</a>
Using Dell Server Update Utility (SUU)	<a href="#">OpenManage Manuals</a>
Using Dell OpenManage Deployment Toolkit (DTK)	<a href="#">OpenManage Manuals</a>
Using iDRAC virtual media	<a href="#">iDRAC Manuals</a>

## Options to download and install OS drivers

You can choose any one of the following options to download and install OS drivers. For information about how to download or install OS drivers, see the documentation links provided in the table below.

**Table 29. Options to download and install OS drivers**

Option	Documentation
Dell support site	<a href="#">Downloading drivers and firmware</a> section.
iDRAC virtual media	<a href="#">Integrated Dell Remote Access Controller User's Guide</a> or for system specific, go to <a href="#">Integrated Dell Remote Access Controller User's Guide</a> > <b>Product Support</b> page of your system > <b>Documentation</b> . <b>i</b> <b>NOTE:</b> To determine the most recent iDRAC release for your platform and for latest documentation version, see <a href="#">Integrated Dell Remote Access Controller Release Notes</a> .

## Downloading drivers and firmware

It is recommended that you download and install the latest BIOS, drivers, and systems management firmware on the system.

### Prerequisites

Ensure that you clear the web browser cache before downloading the drivers and firmware.

### Steps

1. Go to [Drivers](#).
2. Enter the Service Tag of the system in the **Enter a Dell Service Tag, Dell Product ID or Model** field, and then press Enter.

**i** **NOTE:** If you do not have the Service Tag, click **Browse all products**, and navigate to your product.

3. On the displayed product page, click **Drivers & Downloads**.  
On the **Drivers & Downloads** page, all drivers that are applicable to the system are displayed.
4. Download the drivers to a USB drive, CD, or DVD.

# Pre-operating system management applications

You can manage basic settings and features of a system without booting to the operating system by using the system firmware.

## Options to manage the pre-operating system applications

You can use any one of the following options to manage the pre-operating system applications:

- System Setup
- Dell Lifecycle Controller
- Boot Manager
- Preboot Execution Environment (PXE)

### Topics:

- [System Setup](#)
- [Dell Lifecycle Controller](#)
- [Boot Manager](#)
- [PXE boot](#)

## System Setup

Using the

**System Setup** option, you can configure the BIOS settings, iDRAC settings, and device settings of the system.

You can access system setup by using any one of the following interfaces:

- Graphical User interface — To access go to iDRAC Dashboard, click **Configurations > BIOS Settings**.
- Text browser — To enable the text browser, use the Console Redirection.

To view

**System Setup**, power on the system, press F2, and click **System Setup Main Menu**.

 **NOTE:** If the operating system begins to load before you press F2, wait for the system to finish booting, and then restart the system and try again.

The options on the

**System Setup Main Menu** screen are described in the following table:

**Table 30. System Setup Main Menu**

Option	Description
<b>System BIOS</b>	Enables you to configure the BIOS settings.
<b>iDRAC Settings</b>	Enables you to configure the iDRAC settings. The iDRAC settings utility is an interface to set up and configure the iDRAC parameters by using UEFI (Unified Extensible Firmware Interface). You can enable or disable various iDRAC parameters by using the iDRAC settings utility. For more information about this utility, see <a href="#">Integrated Dell Remote Access Controller User's Guide</a>

**Table 30. System Setup Main Menu (continued)**

Option	Description
<b>Device Settings</b>	Enables you to configure device settings for devices such as storage controllers or network cards.
<b>Service Tag Settings</b>	Enables you to configure the System Service Tag.

## System BIOS

To view the **System BIOS** screen, power on the system, press F2, and click **System Setup Main Menu > System BIOS**.

**Table 31. System BIOS details**

Option	Description
<b>System Information</b>	Provides information about the system such as the system model name, BIOS version, and Service Tag.
<b>Memory Settings</b>	Specifies information and options related to the installed memory.
<b>Processor Settings</b>	Specifies information and options related to the processor such as speed and cache size.
<b>SATA Settings</b>	Specifies options to enable or disable the embedded SATA controller and ports.
<b>Boot Settings</b>	Specifies options to specify the Boot mode (UEFI). Enables you to modify UEFI boot settings.
<b>Network Settings</b>	Specifies options to manage the UEFI network settings and boot protocols. Legacy network settings are managed from the <b>Device Settings</b> menu.  <b>NOTE:</b> Network Settings are not supported in BIOS boot mode.
<b>Integrated Devices</b>	Specifies options to manage integrated device controllers and ports, specifies related features, and options.
<b>Serial Communication</b>	Specifies options to manage the serial ports, its related features, and options.
<b>System Profile Settings</b>	Specifies options to change the processor power management settings, memory frequency.
<b>System Security</b>	Specifies options to configure the system security settings, such as system password, setup password, Trusted Platform Module (TPM) security, and UEFI secure boot. It also manages the power button on the system.
<b>Redundant OS Control</b>	Sets the redundant OS information for redundant OS control.
<b>Miscellaneous Settings</b>	Specifies options to change the system date and time.

## System Information

To view the **System Information** screen, power on the system, press F2, and click **System Setup Main Menu > System BIOS > System Information**.

**Table 32. System Information details**

Option	Description
<b>System Model Name</b>	Specifies the system model name.
<b>System BIOS Version</b>	Specifies the BIOS version installed on the system.
<b>System Management Engine Version</b>	Specifies the current version of the Management Engine firmware.
<b>System Service Tag</b>	Specifies the system Service Tag.

**Table 32. System Information details (continued)**

Option	Description
<b>System Manufacturer</b>	Specifies the name of the system manufacturer.
<b>System Manufacturer Contact Information</b>	Specifies the contact information of the system manufacturer.
<b>System CPLD Version</b>	Specifies the current version of the system Complex Programmable Logic Device (CPLD) firmware.
<b>UEFI Compliance Version</b>	Specifies the UEFI compliance level of the system firmware.

## Memory Settings

To view the **Memory Settings** screen, power on the system, press F2, and click **System Setup Main Menu > System BIOS > Memory Settings**.

**Table 33. Memory Settings details**

Option	Description
<b>System Memory Size</b>	Specifies the size of the system memory.
<b>System Memory Type</b>	Specifies the type of memory installed in the system.
<b>System Memory Speed</b>	Specifies the speed of the system memory.
<b>Video Memory</b>	Specifies the size video memory.
<b>System Memory Testing</b>	Specifies whether the system memory tests are run during system boot. The two options available are <b>Enabled</b> and <b>Disabled</b> . This option is set to <b>Disabled</b> by default.
<b>Memory Operating Mode</b>	This field selects the memory operating mode. This feature is active only if a valid memory configuration is detected. When <b>Optimizer Mode</b> is enabled, the DRAM controllers operate independently in 64-bit mode and provide optimized memory performance.
<b>Current State of Memory Operating Mode</b>	Specifies the current state of the memory operating mode.
<b>Memory training</b>	<p>When option is set to <b>Fast</b> and memory configuration is not changed, the system uses previously saved memory training parameters to train the memory subsystems and system boot time is also reduced. If memory configuration is changed, the system automatically enables <b>Retrain at Next boot</b> to force one-time full memory training steps, and then go back to <b>Fast</b> afterward.</p> <p>When option is set to <b>Retrain at Next boot</b>, the system performs the force one-time full memory training steps at next power on and boot time is slowed on next boot.</p> <p>When option is set to <b>Enable</b>, the system performs the force full memory training steps on every power on and boot time is slowed on every boot.</p>
<b>DIMM Population</b>	Provides information about the DIMM slots which has an installed DIMM.

## Processor Settings

To view the **Processor Settings** screen, power on the system, press F2, and click **System Setup Main Menu > System BIOS > Processor Settings**.

**Table 34. Processor Settings details**

Option	Description
<b>Logical Processor</b>	Each processor core supports up to two logical processors. If this option is set to <b>Enabled</b> , the BIOS displays all the logical processors. If this option is set to <b>Disabled</b> , the BIOS displays only one logical processor per core. This option is set to <b>Enabled</b> by default.
<b>Virtualization Technology</b>	Enables or disables the virtualization technology for the processor. This option is set to <b>Enabled</b> by default.
<b>Kernel DMA Protection</b>	When set to <b>Enabled</b> , using Virtualization Technology, BIOS, and Operating System will enable direct memory access protection for DMA capable peripheral devices. Enable Virtualization technology to use this option. This option is set to <b>Disabled</b> by default.
<b>Adjacent Cache Line Prefetch</b>	Optimizes the system for applications that need high utilization of sequential memory access. This option is set to <b>Enabled</b> by default. You can disable this option for applications that need high utilization of random memory access.
<b>Hardware Prefetcher</b>	Enables or disables the hardware prefetcher. This option is set to <b>Enabled</b> by default.
<b>LLC Prefetch</b>	Enables or disables the LLC Prefetch on all threads. This option is set to <b>Disabled</b> by default.
<b>Dead Line LLC Alloc</b>	Enables or disables the Dead Line LLC Alloc. This option is set to <b>Enabled</b> by default. You can enable this option to enter the dead lines in LLC or disable the option to not enter the dead lines in LLC.
<b>Directory AtoS</b>	Enables or disables the Directory AtoS. AtoS optimization reduces remote read latencies for repeat read accesses without intervening writes. This option is set to <b>Disabled</b> by default.
<b>x2APIC Mode</b>	Enables or disables x2APIC mode. This option is set to <b>Enabled</b> by default. <i>i</i> <b>NOTE:</b> For two processors 64 cores configuration, x2APIC mode is not switchable if 256 threads are enabled (BIOS settings: All CCD, cores, and logical processors enabled). <i>i</i> <b>NOTE:</b> x2APIC Mode has a dependency on Virtualization Technology. x2APIC Mode will take the setting assigned to Virtualization Technology and cannot be manually changed.
<b>Number of Cores per Processor</b>	This option is set to <b>All</b> by default.
<b>Processor Core Speed</b>	Specifies the maximum core frequency of the processor.

**Table 35. Processor details**

Option	Description
<b>Family-Model-Stepping</b>	Specifies the family, model, and stepping of the processor as defined by Intel.
<b>Brand</b>	Specifies the brand name.

**Table 35. Processor details (continued)**

Option	Description
<b>Level 2 Cache</b>	Specifies the total L2 cache.
<b>Level 3 Cache</b>	Specifies the total L3 cache.
<b>Number of Cores</b>	Specifies the number of cores per processor.
<b>Microcode</b>	Specifies the processor microcode version.

## SATA Settings

To view the **SATA Settings** screen, power on the system, press F2, and click **System Setup Main Menu > System BIOS > SATA Settings**.

**Table 36. SATA Settings details**

Option	Description
<b>Embedded SATA</b>	Enables the embedded SATA option to be set to <b>Off</b> , <b>AHCI mode</b> , or <b>RAID modes</b> . This option is set to <b>AHCI Mode</b> by default.  <b>NOTE:</b> No ESXi and Ubuntu OS support under RAID mode.
<b>Security Freeze Lock</b>	Sends <b>Security Freeze Lock</b> command to the embedded SATA drives during POST. This option is applicable only for AHCI Mode. This option is set to <b>Enabled</b> by default.
<b>Write Cache</b>	Enables or disables the command for the embedded SATA drives during POST. This option is applicable only for AHCI Mode. This option is set to <b>Disabled</b> by default.
<b>Port n</b>	Sets the drive type of the selected device.  For <b>AHCI Mode</b> , BIOS support is always enabled.

**Table 37. Port n**

Options	Descriptions
<b>Model</b>	Specifies the drive model of the selected device.
<b>Drive Type</b>	Specifies the type of drive attached to the SATA port.
<b>Capacity</b>	Specifies the total capacity of the drive. This field is undefined for removable media devices such as optical drives.

## Boot Settings

The **Boot Settings** only support **UEFI** mode.



- **UEFI:** The Unified Extensible Firmware Interface (UEFI) is a new interface between operating systems and platform firmware. The interface consists of data tables with platform related information, boot and runtime service calls that are available to the operating system and its loader. The following benefits are available when the **Boot Mode** is set to **UEFI**:
  - Support for drive partitions larger than 2 TB.
  - Enhanced security (e.g., UEFI Secure Boot).
  - Faster boot time.

 **NOTE:** You must use only the UEFI boot mode in order to boot from NVMe drives.

To view the **Boot Settings** screen, power on the system, press F2, and click **System Setup Main Menu > System BIOS > Boot Settings**.



**Table 38. Boot Settings details**

Option	Description
<b>Boot Mode</b>	<p>Enables you to set the boot mode of the system. If the operating system supports UEFI, you can set this option to UEFI. Setting this field to BIOS allows compatibility with non-UEFI operating systems.</p> <p> <b>CAUTION: Switching the boot mode may prevent the system from booting if the operating system is not installed in the same boot mode.</b></p> <p> <b>NOTE:</b> Setting this field to UEFI disables the <b>BIOS Boot Settings</b> menu.</p>
<b>Boot Sequence Retry</b>	<p>Enables or disables the Boot sequence retry feature or resets the system. When this option is set to <b>Enabled</b> and the system fails to boot, the system re-attempts the boot sequence after 30 seconds. When this option is set to <b>Reset</b> and the system fails to boot, the system reboots immediately. This option is set to <b>Enabled</b> by default.</p>
<b>Generic USB Boot</b>	<p>Enables or disables the generic USB boot placeholder. This option is set to <b>Disabled</b> by default.</p>
<b>Hard-disk Drive Placeholder</b>	<p>Enables or disables the Hard-disk drive placeholder. This option is set to <b>Disabled</b> by default.</p>
<b>Clean all Sysprep variables and order</b>	<p>When this option is set to <b>None</b>, BIOS will do nothing. When set to <b>Yes</b>, BIOS will delete variables of SysPrep #### and SysPrepOrder this option is a onetime option, will reset to none when deleting variables. This setting is only available in <b>UEFI Boot Mode</b>. This option is set to <b>None</b> by default.</p>
<b>UEFI Boot Settings</b>	<p>Specifies the UEFI boot sequence. Enables or disables UEFI Boot options.</p> <p> <b>NOTE:</b> This option controls the UEFI boot order. The first option in the list will be attempted first.</p>

**Table 39. UEFI Boot Settings**

Option	Description
<b>UEFI Boot Sequence</b>	Enables you to change the boot device order.
<b>Boot Option Enable/Disable</b>	Enables you to select the enabled or disabled boot devices

## Choosing system boot mode

System Setup enables you to specify one of the following boot modes for installing your operating system:

- UEFI boot mode (the default), is an enhanced 64-bit boot interface. If you have configured your system to boot to UEFI mode, it replaces the system BIOS.
1. From the **System Setup Main Menu**, click **Boot Settings**, and select **Boot Mode**.
  2. Select the UEFI boot mode you want the system to boot into.

 **CAUTION: Switching the boot mode may prevent the system from booting if the operating system is not installed in the same boot mode.**

3. After the system boots in the specified boot mode, proceed to install your operating system from that mode.

 **NOTE:** Operating systems must be UEFI-compatible to be installed from the UEFI boot mode. DOS and 32-bit operating systems do not support UEFI and can only be installed from the BIOS boot mode.

 **NOTE:** For the latest information about supported operating systems, go to [Dell OS Support](#).

## Changing boot order

### About this task

You may have to change the boot order if you want to boot from a USB key.

## Steps

1. On the **System Setup Main Menu** screen, click **System BIOS > Boot Settings > UEFI Boot Settings > UEFI Boot Sequence**.
2. Use the arrow keys to select a boot device, and use the plus (+) and minus (-) sign keys to move the device down or up in the order.
3. Click **Exit**, and then click **Yes** to save the settings on exit.

 **NOTE:** You can also enable or disable boot order devices as needed.

## Network Settings

To view the **Network Settings** screen, power on the system, press F2, and click **System Setup Main Menu > System BIOS > Network Settings**.

 **NOTE:** Network Settings are not supported in BIOS boot mode.

**Table 40. Network Settings details**

Option	Description
<b>UEFI PXE Settings</b>	Enables you to control the configuration of the UEFI PXE device.
<b>Number of PXE Devices</b>	Enables you to choose the number of PXE Devices from 1 to 4, 8, 12, 16.
<b>PXE Device n</b> (n = 1 to 16)	Enables or disables the device. When enabled, a UEFI PXE boot option is created for the device.
<b>PXE Device n Settings</b> (n = 1 to 16)	Enables you to control the configuration of the PXE device.
<b>UEFI HTTP Settings</b>	Enables you to control the configuration of the UEFI HTTP device.
<b>HTTP Device n</b> (n = 1 to 4)	Enables or disables the device. When enabled, a UEFI HTTP boot option is created for the device.
<b>HTTP Device n Settings</b> (n = 1 to 4)	Enables you to control the configuration of the HTTP device.
<b>UEFI iSCSI Settings</b>	Enables you to control the configuration of the iSCSI device.

**Table 41. PXE Device n Settings details**

Option	Description
<b>Interface</b>	Specifies the NIC interface used for the PXE device.
<b>Protocol</b>	Specifies Protocol used for PXE device. This option is set to <b>IPv4</b> or <b>IPv6</b> . This option is set to <b>IPv4</b> by default.
<b>VLAN</b>	Enables Vlan for PXE device. This option is set to <b>Enabled</b> or <b>Disabled</b> . This option is set to <b>Disabled</b> by default.
<b>VLAN ID</b>	Shows the Vlan ID for the PXE device
<b>VLAN Priority</b>	Shows the Vlan Priority for the PXE device.

**Table 42. HTTP Device n Settings details**

Option	Description
<b>Interface</b>	Specifies the NIC interface used for the HTTP device.
<b>Protocol</b>	Specifies Protocol used for HTTP device. This option is set to <b>IPv4</b> or <b>IPv6</b> . This option is set to <b>IPv4</b> by default.
<b>VLAN</b>	Enables Vlan for HTTP device. This option is set to <b>Enable</b> or <b>Disable</b> . This option is set to <b>Disable</b> by default.
<b>VLAN ID</b>	Shows the Vlan ID for the HTTP device
<b>Vlan Priority</b>	Shows the Vlan Priority for the HTTP device.

**Table 42. HTTP Device n Settings details (continued)**

Option	Description
<b>DHCP</b>	Enables or disables DHCP for this HTTP device. This option is set to <b>Enabled</b> by default.
<b>IP Address</b>	Specifies IP address for the HTTP device.
<b>Subnet Mask</b>	Specifies subnet mask for the HTTP device.
<b>Autoconfiguration</b>	Enables or disables the <b>IPv6Autoconfiguration</b> for the HTTP Device. When set to Enabled, IPv6 Address and Gateway are retrieved from Autoconfiguration mechanism.
<b>IPv6 Address</b>	IPv6 Unicast address for this HTTP Device.
<b>Prefix Length</b>	IPv6 Prefix Length (0~127) for this HTTP Device.
<b>Gateway</b>	Specifies gateway for the HTTP device.
<b>DNS info via DHCP</b>	Enables or disables DNS Information from DHCP. This option is set to <b>Enabled</b> by default.
<b>Primary DNS</b>	Specifies the primary DNS server IP address for the HTTP Device.
<b>Secondary DNS</b>	Specifies the secondary DNS server IP address for the HTTP Device.
<b>URI (will obtain from DHCP server if not specified)</b>	Obtain URI from the DHCP server if not specified
<b>TLS Authentication Configuration</b>	Specifies the option for TLS authentication configuration. View or modify the device's boot TLS Authentication Mode. This option is set to <b>One Way</b> by default. <b>None</b> means the HTTP server and the client will not authenticate each other for this boot.

 **NOTE:** Autoconfiguration, Prefix Length and IPv6 Address options are visible only when **Protocol** is set to **IPv6**

**Table 43. UEFI iSCSI Settings screen details**

Option	Description
<b>iSCSI Initiator Name</b>	Specifies the name of the iSCSI initiator in IQN format.
<b>iSCSI Device1</b>	Enables or disables the iSCSI device. When disabled, a UEFI boot option is created for the iSCSI device automatically. This is set to <b>Disabled</b> by default.
<b>iSCSI Device1 Settings</b>	Enables you to control the configuration of the iSCSI device.

**Table 44. iSCSI Device1 Settings screen details**

Option	Description
<b>Connection 1</b>	Enables or disables the iSCSI connection. This option is set to <b>Disabled</b> by default.
<b>Connection 2</b>	Enables or disables the iSCSI connection. This option is set to <b>Disabled</b> by default.
<b>Connection 1 Settings</b>	Enables you to control the configuration for the iSCSI connection.
<b>Connection 2 Settings</b>	Enables you to control the configuration for the iSCSI connection.
<b>Connection Order</b>	Enables you to control the order for which the iSCSI connections will be attempted.

## Integrated Devices

To view the **Integrated Devices** screen, power on the system, press F2, and click **System Setup Main Menu > System BIOS > Integrated Devices**.

**Table 45. Integrated Devices details**

Option	Description
<b>User Accessible USB Ports</b>	<p>Configures the user accessible USB ports. Selecting <b>Only Back Ports On</b> disables the front USB ports; selecting <b>All Ports Off</b> disables all front and back USB ports. This option is set to <b>All Ports On</b> by default.</p> <p>The USB keyboard and mouse still function in certain USB ports during the boot process, depending on the selection. After the boot process is complete, the USB ports will be enabled or disabled as per the setting.</p>
<b>Internal USB Port</b>	<p>Enables or disables the internal USB port. This option is set to <b>ON</b> by default.</p>
<b>iDRAC Direct USB Port</b>	<p>The iDRAC Direct USB port is managed by iDRAC exclusively with no host visibility. This option is set to <b>ON</b> or <b>OFF</b>. When set to <b>OFF</b>, iDRAC does not detect any USB devices installed in this managed port. This option is set to <b>On</b> by default.</p>
<b>Embedded NIC1 and NIC2</b>	<p>Enables or disables the OS interface of the Embedded NIC1 and NIC2 controller. If set to <b>Disabled (OS)</b>, the NIC may still be available for shared network access by the embedded management controller. Configure the <b>Embedded NIC1 and NIC2</b> option by using the NIC management utilities of the system. This option is set to <b>Enabled</b> by default.</p>
<b>I/OAT DMA Engine</b>	<p>Enables or disables the I/O Acceleration Technology (I/OAT) option. I/OAT is a set of DMA features designed to accelerate network traffic and lower CPU utilization. Enable only if the hardware and software support the feature. This option is set to <b>Disabled</b> by default.</p>
<b>Embedded Video Controller</b>	<p>Enables or disables the use of Embedded Video Controller as the primary display. When set to <b>Enabled</b>, the Embedded Video Controller will be the primary display even if add-in graphic cards are installed. When set to <b>Disabled</b>, an add-in graphics card is used as the primary display. BIOS will output displays to both the primary add-in video and the embedded video during POST and preboot environment. The embedded video will then be disabled right before the operating system boots. This option is set to <b>Enabled</b> by default.</p> <p><b>NOTE:</b> When there are multiple add-in graphic cards installed in the system, the first card discovered during PCI enumeration is selected as the primary video. You might have to rearrange the cards in the slots in order to control which card is the primary video.</p>
<b>Current State of Embedded Video Controller</b>	<p>Displays the current state of the embedded video controller. The <b>Current State of Embedded Video Controller</b> option is a read-only field. If the Embedded Video Controller is the only display capability in the system (that is, no add-in graphics card is installed), then the Embedded Video Controller is automatically used as the primary display even if the <b>Embedded Video Controller</b> setting is set to <b>Disabled</b>.</p>
<b>OS Watchdog Timer</b>	<p>If your system stops responding, this watchdog timer aids in the recovery of your operating system. When this option is set to <b>Enabled</b>, the operating system initializes the timer. When this option is set to <b>Disabled</b> (the default), the timer does not have any effect on the system.</p>
<b>Empty Slot Unhide</b>	<p>Enables or disables the root ports of all the empty slots that are accessible to the BIOS and operating system. This option is set to <b>Disabled</b> by default.</p>
<b>Slot Disablement</b>	<p>Enables or disables or boot driver disables the available PCIe slots on your system. The slot disablement feature controls the configuration of the PCIe cards installed in the specified slot. Slots must be disabled only when the installed peripheral card prevents booting into the operating system or causes delays in system startup. If the slot is disabled, both the Option ROM and UEFI drivers are disabled. Only slots that are present on the system will be available for control. When this option is set to boot driver disabled, both the Option ROM and UEFI driver from the slot will not run during POST. The system will not boot from the card and its pre-boot services will not be available. However, the card is available to the operating system.</p>

**Table 45. Integrated Devices details (continued)**

Option	Description
	<b>Slot n:</b> Enables or disables or only the boot driver is disabled for the PCIe slot n. This option is set to <b>Enabled</b> by default.

## Serial Communication

To view the **Serial Communication** screen, power on the system, press F2, and click **System Setup Main Menu > System BIOS > Serial Communication**.

**Table 46. Serial Communication details**

Option	Description
<b>Serial Communication</b>	Enables the serial communication options. Selects serial communication devices (Serial Device 1 and Serial Device 2) in BIOS. BIOS console redirection can also be enabled, and the port address can be specified.
<b>Serial Port Address</b>	Enables you to set the port address for serial devices. This option is set to <b>Serial Device1=COM2, Serial Device 2=COM1</b> and set to by default. <i>i</i> <b>NOTE:</b> You can use only Serial Device 2 for the Serial Over LAN (SOL) feature. To use console redirection by SOL, configure the same port address for console redirection and the serial device. <i>i</i> <b>NOTE:</b> Every time the system boots, the BIOS syncs the serial MUX setting that is saved in iDRAC. The serial MUX setting can independently be changed in iDRAC. Loading the BIOS default settings from within the BIOS setup utility may not always revert the serial MUX setting to the default setting of Serial Device 1.
<b>External Serial Connector</b>	Enables you to associate the External Serial Connector to <b>Serial Device 1, Serial Device 2, or the Remote Access Device</b> by using this option. This option is set to <b>Serial Device 1</b> by default. <i>i</i> <b>NOTE:</b> Only Serial Device 2 can be used for Serial Over LAN (SOL). To use console redirection by SOL, configure the same port address for console redirection and the serial device. <i>i</i> <b>NOTE:</b> Every time the system boots, the BIOS syncs the serial MUX setting saved in iDRAC. The serial MUX setting can independently be changed in iDRAC. Loading the BIOS default settings from within the BIOS setup utility may not always revert this setting to the default setting of Serial Device 1.
<b>Failsafe Baud Rate</b>	Specifies the failsafe baud rate for console redirection. The BIOS attempts to determine the baud rate automatically. This failsafe baud rate is used only if the attempt fails, and the value must not be changed. This option is set to <b>115200</b> by default.
<b>Remote Terminal Type</b>	Sets the remote console terminal type. This option is set to <b>VT100/VT220</b> by default.

## System Profile Settings

To view the **System Profile Settings** screen, power on the system, press F2, and click **System Setup Main Menu > System BIOS > System Profile Settings**.

**Table 47. System Profile Settings details**

Option	Description
<b>System Profile</b>	Sets the system profile. If you set the System Profile option to a mode other than <b>Custom</b> , the BIOS automatically sets the rest of the options. You can only change the rest of the

**Table 47. System Profile Settings details (continued)**

Option	Description
	options if the mode is set to <b>Custom</b> . This option is set to <b>Performance Per Watt (OS)</b> by default. Other options include <b>Performance</b> and, <b>Custom</b> . <i>i</i> <b>NOTE:</b> All the parameters on the system profile setting screen are available only when the <b>System Profile</b> option is set to <b>Custom</b> .
<b>CPU Power Management</b>	Sets the CPU power management. This option is set to <b>OS DBPM</b> by default. Other option includes <b>Maximum Performance, OS DBPM</b> .
<b>Memory Frequency</b>	Sets the speed of the system memory. You can select <b>Maximum Performance, Maximum Reliability</b> or a specific speed. This option is set to <b>Maximum Performance</b> by default.
<b>Turbo Boost</b>	Enables or disables the processor to operate in the turbo boost mode. This option is set to <b>Enabled</b> by default.
<b>C1E</b>	Enables or disables the processor to switch to a minimum performance state when it is idle. This option is set to <b>Enabled</b> by default.
<b>C-States</b>	Enables or disables the processor to operate in all available power states. C States allow the processor to enter lower power states when idle. When set to <b>Enabled</b> (OS controlled) or when set to <b>Autonomous</b> (if hardware controlled is supported), the processor can operate in all available Power States to save power, but may increase memory latency and frequency jitter. This option is set to <b>Enabled</b> by default.
<b>Memory Refresh Rate</b>	Sets the memory refresh rate to either 1x or 2x. This option is set to <b>1x</b> by default.
<b>Uncore Frequency</b>	Enables you to select the <b>Uncore Frequency</b> option. <b>Dynamic mode</b> enables the process or to optimize power resources across cores and uncores during runtime. Maximum mode enables the <b>Maximum</b> uncore frequency.
<b>Dynamic Load Line Switch</b>	Dynamic Load Line Switch control. Dynamic Load Line (DLL) is a Power Management feature, which dynamically switches to the performance mode during periods of high CPU utilization. This setting is read-only and set to <b>Enabled</b> when Optimized Power Mode is Enabled. <b>Read - Only</b> unless System Profile is set to Custom.
<b>Monitor/Mwait</b>	Enables the Monitor/Mwait instructions in the processor. This option is set to <b>Enabled</b> for all system profiles, except <b>Custom</b> by default. <i>i</i> <b>NOTE:</b> This option can be disabled when System Profile is set to <b>Custom</b> . <i>i</i> <b>NOTE:</b> <b>Monitor/Mwait</b> has dependency on C States, so ensure that C States option is set to <b>Disabled</b> before changing this item.
<b>PCI ASPM L1 Link Power Management</b>	Enables or disables the PCI <b>ASPM L1 Link Power Management</b> . This option is set to <b>Enabled</b> by default.
<b>Workload Configuration</b>	This feature allows you to select a preconfigured workload profile. This option is set to <b>Balance</b> by default.

## System Security

To view the **System Security** screen, power on the system, press F2, and click **System Setup Main Menu > System BIOS > System Security**.

**Table 48. System Security details**

Option	Description
<b>CPU AES-NI</b>	Improves the speed of applications by performing encryption and decryption by using the Advanced Encryption Standard Instruction Set (AES-NI). This option is set to <b>Enabled</b> by default.
<b>Strong Password Status</b>	If <b>Enabled</b> , you must set a password that has at least one character in lowercase, upper case, digit , and a special character. This option is set to <b>Disabled</b> by default.

**Table 48. System Security details (continued)**

Option	Description
<b>Strong Password Minimum Length (8 to 32)</b>	Allows you to select the minimum characters for the password. You can specify 8-32 characters. This option gets <b>Enabled</b> when the <b>Strong Password Status</b> option is <b>Enabled</b> .
<b>System Password</b>	Sets the system password. This option is set to <b>Enabled</b> by default and is read-only if the password jumper is not installed in the system.
<b>Setup Password</b>	Sets the setup password. This option is read-only if the password jumper is not installed in the system.
<b>Password Status</b>	Locks the system password. This option is set to <b>Unlocked</b> by default.
<b>TPM Information</b>	Indicates the type of Trusted Platform Module, if present.

**Table 49. TPM 2.0 security information**

Option	Description
<b>TPM Information</b>	
<b>TPM Security</b>	 <b>NOTE:</b> The TPM menu is available only when the TPM module is installed. Enables you to control the reporting mode of the TPM. When set to Off, the presence of the TPM is not reported to the OS. When set to On, the presence of the TPM is reported to the OS. The <b>TPM Security</b> option is set to <b>Off</b> by default.
	When TPM 2.0 is installed, the <b>TPM Security</b> option is set to <b>On</b> or <b>Off</b> . This option is set to <b>Off</b> by default.
<b>TPM Information</b>	Indicates the type of Trusted Platform Module, if present.
<b>TPM Firmware</b>	Indicates the firmware version of the TPM.
<b>TPM Hierarchy</b>	Enables, disables, or clears the storage and endorsement hierarchies. When set to <b>Enabled</b> , the storage and endorsement hierarchies can be used.
	When set to <b>Disabled</b> , the storage and endorsement hierarchies cannot be used.
	When set to <b>Clear</b> , the storage and endorsement hierarchies are cleared of any values, and then reset to <b>Enabled</b> .
<b>TPM Advanced Settings</b>	<b>TPM PPI Bypass Provision</b> When set to <b>Enabled</b> , allows the Operating System to bypass Physical Presence Interface (PPI) prompts when issuing PPI Advanced Configuration and Power interface (ACPI) provisioning operations.
	<b>TPM PPI Bypass Clear</b> When set to <b>Enabled</b> allows the Operating System to bypass Physical Presence Interface (PPI) prompts when issuing PPI Advanced Configuration and Power Interface (ACPI) clear operations.
	<b>TPM2 Algorithm Selection</b> Allows the user to change the cryptographic algorithms used in the Trusted Platform Module (TPM). The available options are dependent on the TPM firmware.  To enable TPM2 Algorithm Selection, Intel(R) TXT technology must be disabled.  The TPM2 Algorithm Selection option supports SHA256 by detecting the TPM module. This option is set to <b>SHA256</b> by default.
<b>Intel(R) TXT</b>	Enables you to set the Intel Trusted Execution Technology (TXT) option. To enable the <b>Intel TXT</b> option, virtualization technology and TPM Security must be enabled with Pre-boot measurements. This option is set to <b>Off</b> by default. It is set <b>On</b> for Secure Launch (Firmware Protection) support on Windows 2022.

**Table 50. System Security details**

Option	Description				
<b>Power button:</b>	Enables or disables the power button on the front of the system. This option is set to <b>Enabled</b> by default.				
<b>AC Power Recovery</b>	Sets how the system behaves after AC power is restored to the system. <i>i</i> <b>NOTE:</b> The host system will not power on up until iDRAC Root of Trust (RoT) is completed, host power on will be delayed by minimum 90 seconds after the AC applied.				
<b>AC Power Recovery Delay</b>	Sets the time delay for the system to power up after AC power is restored to the system. This option is set to <b>Immediate</b> by default. When this option is set to <b>Immediate</b> , there is no delay for power up. When this option is set to <b>Random</b> , the system creates a random delay for power up. When this option is set to <b>User Defined</b> , the system delay time is manually to power up.				
<b>User Defined Delay (120 s to 600 s)</b>	Sets the <b>User Defined Delay</b> option when the <b>User Defined</b> option for <b>AC Power Recovery Delay</b> is selected. The actual AC recovery time needs to add iDRAC root of trust time (around 50 seconds).				
<b>UEFI Variable Access</b>	Provides varying degrees of securing UEFI variables. When set to <b>Standard</b> (the default), UEFI variables are accessible in the operating system per the UEFI specification. When set to <b>Controlled</b> , selected UEFI variables are protected in the environment and new UEFI boot entries are forced to be at the end of the current boot order.				
<b>In-Band Manageability Interface</b>	When set to <b>Disabled</b> , this setting hides the Management Engine's (ME), HECI devices, and the system's IPMI devices from the operating system. This prevents the operating system from changing the ME power capping settings, and blocks access to all in-band management tools. All management should be managed through out-of-band. This option is set to <b>Enabled</b> by default. <i>i</i> <b>NOTE:</b> BIOS update requires HECI devices to be operational and DUP updates require IPMI interface to be operational. This setting needs to be set to Enabled to avoid updating errors.				
<b>SMM Security Mitigation</b>	Enables or disables the UEFI SMM security migration protections. It is set to <b>Disabled</b> by default.				
<b>Secure Boot</b>	Enables Secure Boot, where the BIOS authenticates each pre-boot image by using the certificates in the Secure Boot Policy. Secure Boot is set to <b>Disabled</b> by default.				
<b>Secure Boot Policy</b>	When Secure Boot policy is set to <b>Standard</b> , the BIOS uses the system manufacturer's key and certificates to authenticate pre-boot images. When Secure Boot policy is set to <b>Custom</b> , the BIOS uses the user-defined key and certificates. Secure Boot policy is set to <b>Standard</b> by default.				
<b>Secure Boot Mode</b>	<p>Configures how the BIOS uses the Secure Boot Policy Objects (PK, KEK, db, dbx).</p> <p>If the current mode is set to <b>Deployed Mode</b>, the available options are <b>User Mode</b> and <b>Deployed Mode</b>. If the current mode is set to <b>User Mode</b>, the available options are <b>User Mode</b>, <b>Audit Mode</b>, and <b>Deployed Mode</b>.</p> <p>Below are the details of different boot modes available in the <b>Secure Boot Mode</b> option.</p> <table border="0" data-bbox="512 1680 1498 2004"> <tr> <td data-bbox="512 1680 766 1814"><b>User Mode</b></td> <td data-bbox="770 1680 1498 1814">In <b>User Mode</b>, PK must be installed, and BIOS performs signature verification on programmatic attempts to update policy objects. The BIOS allows unauthenticated programmatic transitions between modes.</td> </tr> <tr> <td data-bbox="512 1821 766 2004"><b>Audit mode</b></td> <td data-bbox="770 1821 1498 2004">In <b>Audit Mode</b>, PK is not present. BIOS does not authenticate programmatic update to the policy objects and transitions between modes. The BIOS performs a signature verification on pre-boot images and logs the results in the image Execution Information Table, but executes the images whether they pass</td> </tr> </table>	<b>User Mode</b>	In <b>User Mode</b> , PK must be installed, and BIOS performs signature verification on programmatic attempts to update policy objects. The BIOS allows unauthenticated programmatic transitions between modes.	<b>Audit mode</b>	In <b>Audit Mode</b> , PK is not present. BIOS does not authenticate programmatic update to the policy objects and transitions between modes. The BIOS performs a signature verification on pre-boot images and logs the results in the image Execution Information Table, but executes the images whether they pass
<b>User Mode</b>	In <b>User Mode</b> , PK must be installed, and BIOS performs signature verification on programmatic attempts to update policy objects. The BIOS allows unauthenticated programmatic transitions between modes.				
<b>Audit mode</b>	In <b>Audit Mode</b> , PK is not present. BIOS does not authenticate programmatic update to the policy objects and transitions between modes. The BIOS performs a signature verification on pre-boot images and logs the results in the image Execution Information Table, but executes the images whether they pass				



**Table 50. System Security details (continued)**

Option	Description
	<p>or fail verification. <b>Audit Mode</b> is useful for programmatic determination of a working set of policy objects.</p> <p><b>Deployed Mode</b> <b>Deployed Mode</b> is the most secure mode. In <b>Deployed Mode</b>, PK must be installed and the BIOS performs signature verification on programmatic attempts to update policy objects. <b>Deployed Mode</b> restricts the programmatic mode transitions.</p>
<b>Secure Boot Policy Summary</b>	<p>Specifies the list of certificates and hashes that secure boot uses to authenticate images. Below are the list of options available on the <b>Secure Boot Policy Summary</b> screen:</p> <ol style="list-style-type: none"> <li>1. <b>Platform Key (PK)</b></li> <li>2. <b>Key Exchange Key (KEK) Database Entries</b></li> <li>3. <b>Authorized Signature Database (db) Entries</b></li> </ol> <p>The options above are described through the following fields:</p> <ul style="list-style-type: none"> <li>• Type</li> <li>• Issuer</li> <li>• Subject</li> <li>• Signature Owner GUID</li> </ul> <ol style="list-style-type: none"> <li>4. <b>Forbidden Signature Database (dbx) Entries</b></li> </ol>
<b>Secure Boot Custom Policy Settings</b>	<p>Configures the Secure Boot Custom Policy. To enable this option, set the Secure Boot Policy to <b>Custom</b> option. Below are the list of options available on the <b>Secure Boot Custom Policy Settings</b> screen:</p> <ol style="list-style-type: none"> <li>1. <b>Platform Key (PK)</b></li> <li>2. <b>Key Exchange Key (KEK) Database</b></li> <li>3. <b>Authorized Signature Database (db)</b></li> <li>4. <b>Forbidden Signature Database (dbx)</b></li> <li>5. <b>Delete All Policy Entries (PK, KEK, db, and dbx)</b></li> <li>6. <b>Restore Default Policy Entries (PK, KEK, db, and dbx)</b></li> <li>7. <b>Export Firmware Hash Values</b></li> </ol>
<b>UEFI CA Certificate Scope</b>	<p>This setting controls how the Secure Boot feature uses the industry standard UEFI CA certificate in the Authorized Signature Database (db). For example, system administrators can configure this setting to use the UEFI CA certificate only for verifying boot device firmware (such as RAID controller firmware or NIC firmware) and not for verifying operating system loaders. This is useful in preventing attacks that exploit vulnerable operating system loaders that are signed by the UEFI CA certificate.</p>

## Creating a system and setup password

### Prerequisites

Ensure that the password jumper is enabled. The password jumper enables or disables the system password and setup password features. For more information, see the System board jumper settings section.

**NOTE:** If the password jumper setting is disabled, the existing system password and setup password are deleted and you need not provide the system password to boot the system.

### Steps

1. To enter System Setup, press F2 immediately after turning on or rebooting your system.
2. On the **System Setup Main Menu** screen, click **System BIOS > System Security**.
3. On the **System Security** screen, verify that **Password Status** is set to **Unlocked**.
4. In the **System Password** field, type your system password, and press Enter or Tab.

Use the following guidelines to assign the system password:

- A password can have up to 32 characters.

A message prompts you to reenter the system password.

5. Reenter the system password, and click **OK**.
6. In the **Setup Password** field, type your setup password and press Enter or Tab.  
A message prompts you to reenter the setup password.
7. Reenter the setup password, and click **OK**.
8. Press Esc to return to the System BIOS screen. Press Esc again.

A message prompts you to save the changes.

 **NOTE:** Password protection does not take effect until the system reboots.

## Using your system password to secure your system

### About this task

If you have assigned a setup password, the system accepts your setup password as an alternate system password.

### Steps

1. Turn on or reboot your system.
2. Type the system password and press Enter.

### Next steps

When **Password Status** is set to **Locked**, type the system password and press Enter when prompted at reboot.

 **NOTE:** If an incorrect system password is typed, the system displays a message and prompts you to reenter your password. You have three attempts to type the correct password. After the third unsuccessful attempt, the system displays an error message that the system has stopped functioning and must be turned off. Even after you turn off and restart the system, the error message is displayed until the correct password is entered.

## Deleting or changing system and setup password

### Prerequisites

 **NOTE:** You cannot delete or change an existing system or setup password if the **Password Status** is set to **Locked**.

### Steps

1. To enter System Setup, press F2 immediately after turning on or restarting your system.
2. On the **System Setup Main Menu** screen, click **System BIOS > System Security**.
3. On the **System Security** screen, ensure that **Password Status** is set to **Unlocked**.
4. In the **System Password** field, alter or delete the existing system password, and then press Enter or Tab.
5. In the **Setup Password** field, alter or delete the existing setup password, and then press Enter or Tab.  
If you change the system and setup password, a message prompts you to reenter the new password. If you delete the system and setup password, a message prompts you to confirm the deletion.
6. Press Esc to return to the **System BIOS** screen. Press Esc again, and a message prompts you to save the changes.
7. Select **Setup Password**, change, or delete the existing setup password and press Enter or Tab.

 **NOTE:** If you change the system password or setup password, a message prompts you to reenter the new password. If you delete the system password or setup password, a message prompts you to confirm the deletion.

## Operating with setup password enabled

If **Setup Password** is set to **Enabled**, type the correct setup password before modifying the system setup options.

If you do not type the correct password in three attempts, the system displays the following message:

```
Invalid Password! Number of unsuccessful password attempts: <x> System Halted! Must power down.
```

Even after you power off and restart the system, the error message is displayed until the correct password is typed. The following options are exceptions:

- If **System Password** is not set to **Enabled** and is not locked through the **Password Status** option, you can assign a system password. For more information, see the System Security Settings screen section.
- You cannot disable or change an existing system password.

**NOTE:** You can use the password status option with the setup password option to protect the system password from unauthorized changes.

## Redundant OS Control

To view the **Redundant OS Control** screen, power on the system, press F2, and click **System Setup Main Menu > System BIOS > Redundant OS Control**.

**Table 51. Redundant OS Control details**

Option	Description
<b>Redundant OS Location</b>	Enables you to select a backup disk from the following devices: <ul style="list-style-type: none"> <li>• <b>None</b></li> <li>• <b>BOSS PCIe Cards (Internal M.2 Drives)</b></li> <li>• <b>SATA Port A</b></li> </ul>
<b>Redundant OS State</b>	<p><b>NOTE:</b> This option is disabled if <b>Redundant OS Location</b> is set to <b>None</b>.</p> <p>When set to <b>Visible</b>, the backup disk is visible to the boot list and OS. When set to <b>Hidden</b>, the backup disk is disabled and is not visible to the boot list and OS. This option is set to <b>Visible</b> by default.</p> <p><b>NOTE:</b> BIOS disables the device in hardware, so it is not accessed by the OS.</p>
<b>Redundant OS Boot</b>	<p><b>NOTE:</b> This option is disabled if <b>Redundant OS Location</b> is set to <b>None</b> or if <b>Redundant OS State</b> is set to <b>Hidden</b>.</p> <p>When set to <b>Enabled</b>, BIOS boots to the device specified in <b>Redundant OS Location</b>. When set to <b>Disabled</b>, BIOS preserves the current boot list settings. This option is set to <b>Disabled</b> by default.</p>

## Miscellaneous Settings

To view the **Miscellaneous Settings** screen, power on the system, press F2, and click **System Setup Main Menu > System BIOS > Miscellaneous Settings**.

**Table 52. Miscellaneous Settings details**

Option	Description
<b>System Time</b>	Enables you to set the time on the system.
<b>System Date</b>	Enables you to set the date on the system.
<b>Time Zone</b>	Enables you to select required Time Zone.
<b>Daylight Savings Time</b>	Enables or disables Daylight Savings Time. This option is set to <b>Disabled</b> by default.
<b>Asset Tag</b>	Specifies the asset tag and enables you to modify it for security and tracking purposes.
<b>Keyboard NumLock</b>	Enables you to set whether the system boots with the NumLock enabled or disabled. This option is set to <b>On</b> by default.

**Table 52. Miscellaneous Settings details (continued)**

Option	Description
	 <b>NOTE:</b> This option does not apply to 84-key keyboards.
<b>F1/F2 Prompt on Error</b>	Enables or disables the F1/F2 prompt on error. This option is set to <b>Enabled</b> by default. The F1/F2 prompt also includes keyboard errors.
<b>Dell Wyse P25/P45 BIOS Access</b>	Enables or disables the Dell Wyse P25/P45 BIOS Access. This option is set to <b>Enabled</b> by default.
<b>Power Cycle Request</b>	Enables or disables the Power Cycle Request. This option is set to <b>None</b> by default.
<b>ACPI FPDT</b>	Enables or disables ACPI FPDT information. When set to <b>Enabled</b> , publishes ACPI Firmware Performance Data Table (FPDT) for OS. This option is set to <b>Disabled</b> by default.

## iDRAC Settings

The iDRAC settings is an interface to set up and configure the iDRAC parameters by using UEFI. You can enable or disable various iDRAC parameters by using the iDRAC settings.

 **NOTE:** Accessing some of the features on the iDRAC settings needs the iDRAC Enterprise License upgrade.

For more information about using iDRAC, see *Dell Integrated Dell Remote Access Controller User's Guide* at [iDRAC Manuals](#).

## Device Settings

**Device Settings** enables you to configure device parameters such as storage controllers or network cards.

## Service Tag Settings

**Service Tag Settings** enables you to configure the System Service Tag.

## Dell Lifecycle Controller

Dell Lifecycle Controller (LC) provides advanced embedded systems management capabilities including system deployment, configuration, update, maintenance, and diagnosis. LC is delivered as part of the iDRAC out-of-band solution and Dell system embedded Unified Extensible Firmware Interface (UEFI) applications.

## Embedded system management

The Dell Lifecycle Controller provides advanced embedded system management throughout the lifecycle of the system. The Dell Lifecycle Controller is started during the boot sequence and functions independently of the operating system.

 **NOTE:** Certain platform configurations may not support the full set of features provided by the Dell Lifecycle Controller.

For more information about setting up the Dell Lifecycle Controller, configuring hardware and firmware, and deploying the operating system, see the Dell Lifecycle Controller documentation at [iDRAC Manuals](#).

## Boot Manager

The **Boot Manager** option enables you to select boot options and diagnostic utilities.

To enter **Boot Manager**, power on the system and press F11.

**Table 53. Boot Manager details**

<b>Option</b>	<b>Description</b>
<b>Continue Normal Boot</b>	The system attempts to boot to devices starting with the first item in the boot order. If the boot attempt fails, the system continues with the next item in the boot order until the boot is successful or no more boot options are found.
<b>One-shot UEFI Boot Menu</b>	Enables you to access boot menu, where you can select a one-time boot device to boot from.
<b>Launch System Setup</b>	Enables you to access System Setup.
<b>Launch Lifecycle Controller</b>	Exits the Boot Manager and invokes the Dell Lifecycle Controller program.
<b>System Utilities</b>	Enables you to launch System Utilities menu such as Launch Diagnostics, BIOS update File Explorer, Reboot System.

## PXE boot

You can use the Preboot Execution Environment (PXE) option to boot and configure the networked systems remotely.

To access the **PXE boot** option, boot the system and then press F12 during POST instead of using standard Boot Sequence from BIOS Setup. It does not pull any menu or allows managing of network devices.

# Minimum to POST

This section describes the minimum to POST system requirement of the Dell system.

## Topics:

- [Minimum configuration to POST](#)
- [Configuration validation](#)

## Minimum configuration to POST

The components that are listed below are the minimum configuration to POST:

- Processor
- One memory module (UDIMM ECC) in slot A1
- Cabled power supply unit
- System board + Front I/O board
- Processor Heatsink
- PSU convert cable
- FIO cable

## Configuration validation

The new generation of Dell systems have added interconnect flexibility and advanced iDRAC management features to collect precise system configuration information and report configuration errors.

When the system is powered on, information about installed cables, risers, backplanes, power supplies, floating card (fPERC, adapter PERC , BOSS), and processor is obtained from the CPLD and backplane memory maps are analyzed. This information forms a unique configuration, which is compared with one of the qualified configurations that are stored in a table that is maintained by iDRAC.

One or more sensors are assigned to each of the configuration elements. During POST, any configuration validation error is logged in the System Event Log (SEL)/LifeCycle (LC) log. The reported events are categorized in the configuration validation error table.

**Table 54. Configuration validation error**

Error	Description	Possible cause and recommendations	Example
Config Error	A configuration element within the closest match contains something that is unexpected and does not match any Dell qualified configuration.	Wrong configuration	Config Error: Backplane cable CTRS_SRC_SA1 and BP-DST_SA1
		The element reported in HWC8010 errors are assembled incorrectly. Verify element (cable, risers, etc) placement in the system.	Config Error : SL Cable PLANAR_SL7 and CTRL_DST_PA1
Config Missing	iDRAC found a configuration element missing within the closest match detected.	Missing or damaged cable, device, or part	Config Missing: Float card front PERC/HBAadapter PERC/HBA
		Missing element or cable is reported in HWC8010 error logs. Install the	Config Missing : SL cable PLANAR_SL8 and CTRL_DST_PA1

**Table 54. Configuration validation error (continued)**

Error	Description	Possible cause and recommendations	Example
		missing element (cable, risers, etc).	
Comm Error	A configuration element is not responding to iDRAC using the management interface while running an inventory check.	System management sideband communication Unplug AC Power, reseal the element and replace the element if the problem persists.	Comm Error: Backplane 2

## Error messages

This section describes the error messages that are displayed on the screen during POST or captured in the system event log (SEL)/LifeCycle (LC) log.

**Table 55. Error message HWC8010**

Error code	HWC8010
Message	The System Configuration Check operation that is resulted in the following issue involving the indicated component type
Arguments	Riser, floating card (fPERC, adapter PERC, BOSS), backplane, processor, cable, or other components
Detailed Description	The issue that is identified in the message is observed in the System Configuration Check operation.
Recommended Response Action	Do the following and retry the operation: <ol style="list-style-type: none"> <li>1. Disconnect the input power.</li> <li>2. Check for proper cable connection and component placement. If the issue persists, contact the service provider.</li> </ol>
Category	System Health (HWC = Hardware Config)
Severity	Critical
Trap/EventID	2329

**Table 56. Error message HWC8011**

Error code	HWC8011
Message	The System Configuration Check operation that is resulted in multiple issues involving the indicated component type
Arguments	Riser, floating card (fPERC, adapter PERC, BOSS), backplane, processor, cable, or other components
Detailed Description	Multiple issues are observed in the System Configuration Check operation.
Recommended Response Action	Do the following and retry the operation: <ol style="list-style-type: none"> <li>1. Disconnect the input power.</li> <li>2. Check for proper cable connection and component placement. If the issue persists, contact the service provider.</li> </ol>
Category	System Health (HWC = Hardware Config)
Severity	Critical

# Disassembly and reassembly

## Topics:

- Safety instructions
- Before working inside your system
- After working inside your system
- Recommended tools
- System cover
- Air shroud
- Intrusion switch
- Drives
- Cooling fans
- Cable routing
- System memory
- Processor and heat sink module
- Expansion cards and expansion card risers
- Optional BOSS-N1 module
- Power supply unit
- System battery
- System board
- Trusted Platform Module
- Control panel

## Safety instructions

**CAUTION:** Many repairs may only be done by a certified service technician. You should only perform troubleshooting and simple repairs as authorized in your product documentation, or as directed by the online or telephone service and support team. Damage due to servicing that is not authorized by Dell is not covered by your warranty. Read and follow the safety instructions that are shipped with your product.

**NOTE:** It is recommended that you always use an antistatic mat and antistatic strap while working on components inside the system.

**NOTE:** Only use certified Optical Fiber Transceiver Class I Laser Products.

## Before working inside your system

### Prerequisites

Follow the safety guidelines listed in the [Safety instructions](#).

### Steps

1. Power off the system and all attached peripherals.
2. Disconnect the system from the electrical outlet and disconnect the peripherals.
3. Remove the system cover.



# After working inside your system

## Prerequisites

Follow the safety guidelines listed in [Safety instructions](#).

## Steps

1. Replace the system cover.
2. Reconnect the peripherals and connect the system to the electrical outlet, and then power on the system.

# Recommended tools

You may need some or all of the following tools to perform the removal and installation procedures:

- Phillips 1 screwdriver
- Phillips 2 screwdriver
- Torx T15 screwdriver
- 5 mm hex nut screwdriver
- Plastic scribe
- 1/4-inch flat blade screwdriver
- Wrist grounding strap connected to the ground
- ESD mat
- Needle-nose pliers

# System cover

## Removing the system cover

### Prerequisites

1. Follow the safety guidelines listed in [Safety instructions](#).
2. Power off the system, and any attached peripherals.
3. Disconnect the system from the electrical outlet and peripherals.

### Steps

1. Loosen the two screws of the rear wall.
2. Slide the Right cover.
3. Lift the Right cover from the system.

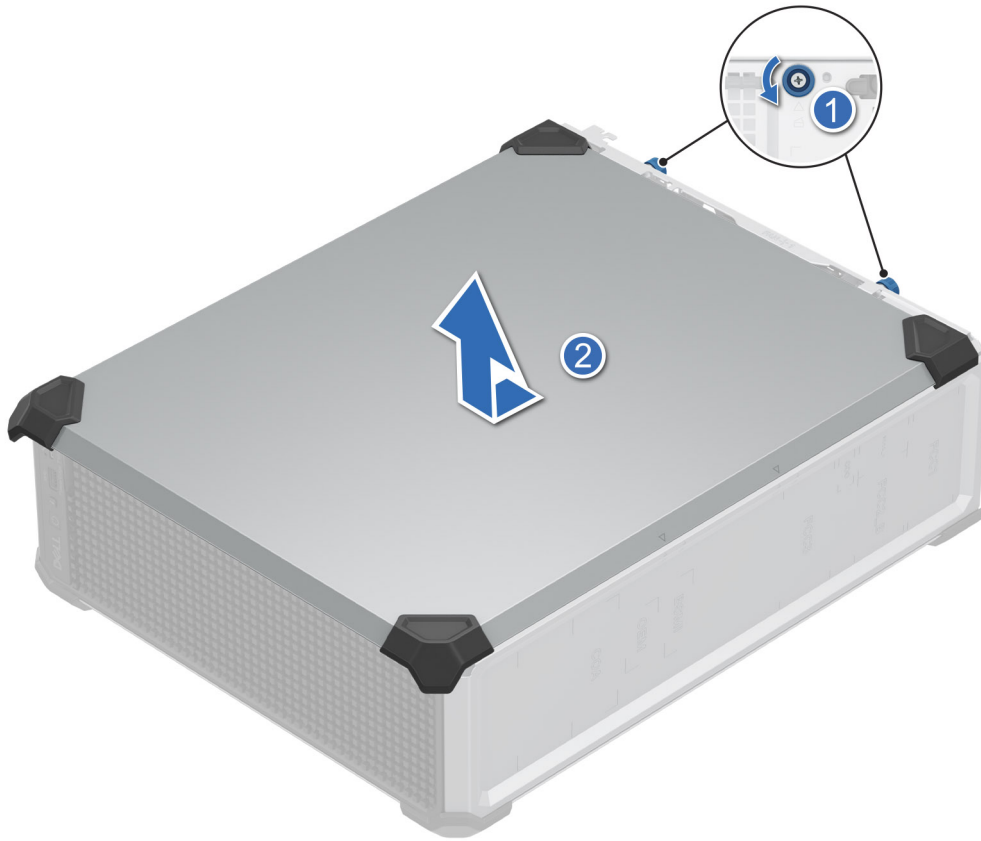

Figure 12. Removing the system cover

### Next steps

Replace the system cover.

## Installing the system cover

### Prerequisites

1. Follow the safety guidelines listed in [Safety instructions](#).
2. Follow the procedure listed in [Before working inside your system](#).

**i** **NOTE:** Ensure that all internal cables are connected and routed properly, and that there are no tools or extra parts that are left inside the system.

### Steps

1. Place the Right cover on the chassis. Align the tabs on the system cover with the guide slots on the system.
2. Slide to Install the Right cover.

**i** **NOTE:** Ensure that the system cover closes without obstruction or unnecessary force. Reseat any cables or components or realign the system cover if necessary.

3. Tighten the two screws at the rear wall.

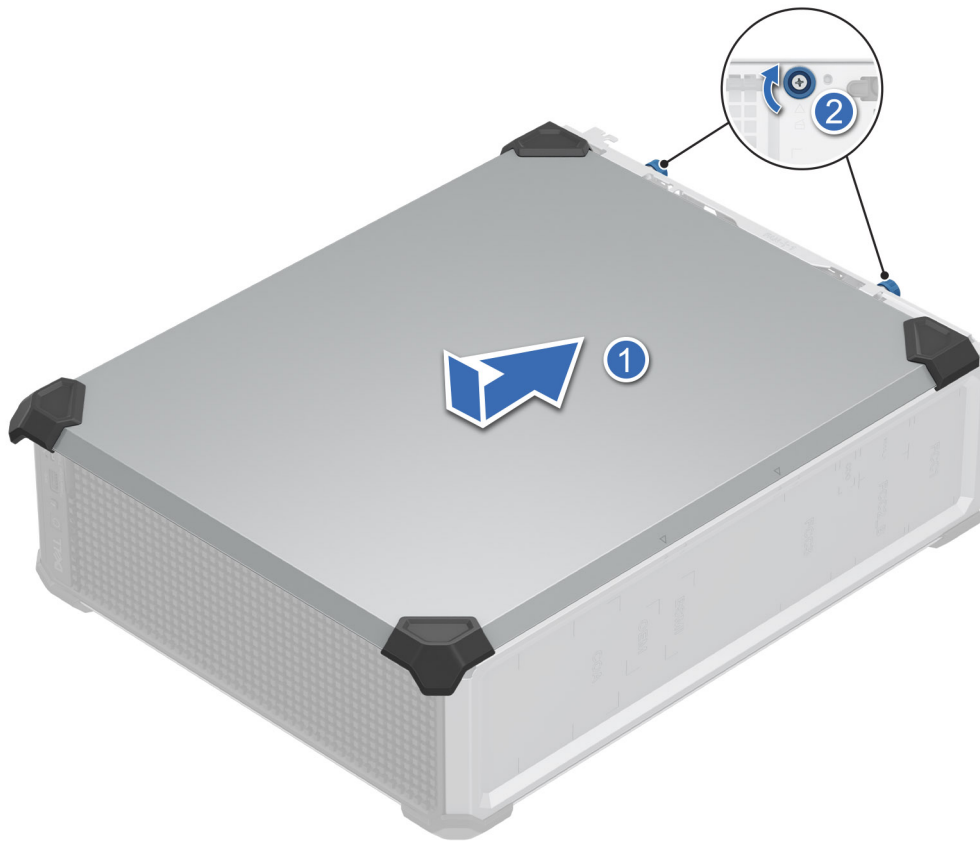

**Figure 13. Installing the system cover**

**Next steps**

1. Reconnect the peripherals and connect the system to the electrical outlet.
2. Power on the system, including all attached peripherals.

# Air shroud

## Removing the air shroud

### Prerequisites

**CAUTION:** Never operate your system with the air shroud removed. The system may get overheated quickly, resulting in shutdown of the system and loss of data.

1. Follow the safety guidelines listed in [Safety instructions](#).
2. Follow the procedure listed in [Before working inside your system](#).

### Steps

Hold the edges of the air shroud, and lift the air shroud out of the system.

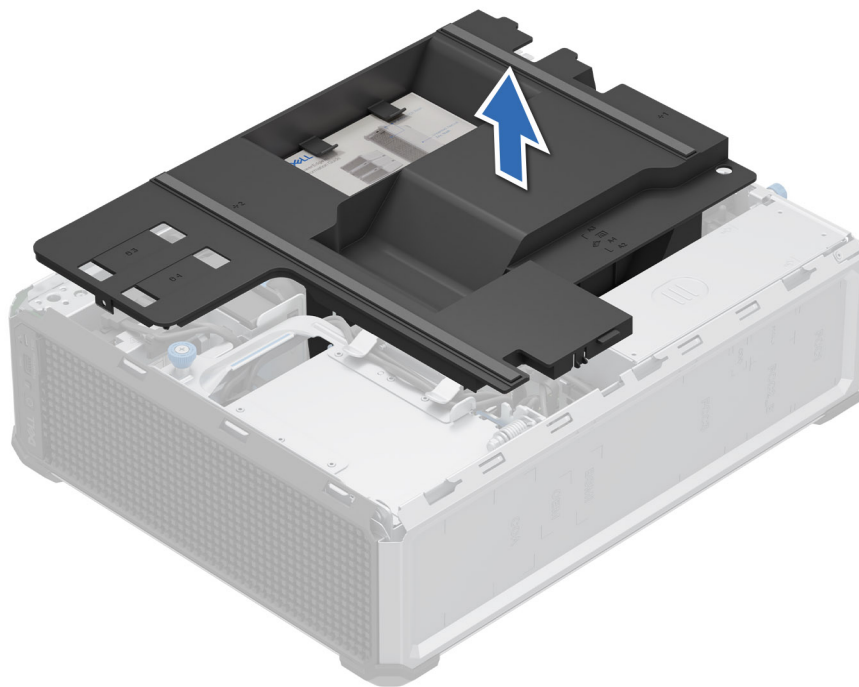

Figure 14. Removing the air shroud

**NOTE:** If the SIB is missing, please scan the QR code on the air shroud for SIB contents.

### Next steps

[Replace the air shroud.](#)

## Installing the air shroud

### Prerequisites

1. Follow the safety guidelines listed in [Safety instructions](#).
2. Follow the procedure listed in [Before working inside your system](#).
3. If applicable, route the cables inside the system along the chassis wall and secure the cables by using the cable-securing bracket.

### Steps

1. Align the tabs on the air shroud with the guide pins on the system.
2. Lower the air shroud into the system, until firmly seated.

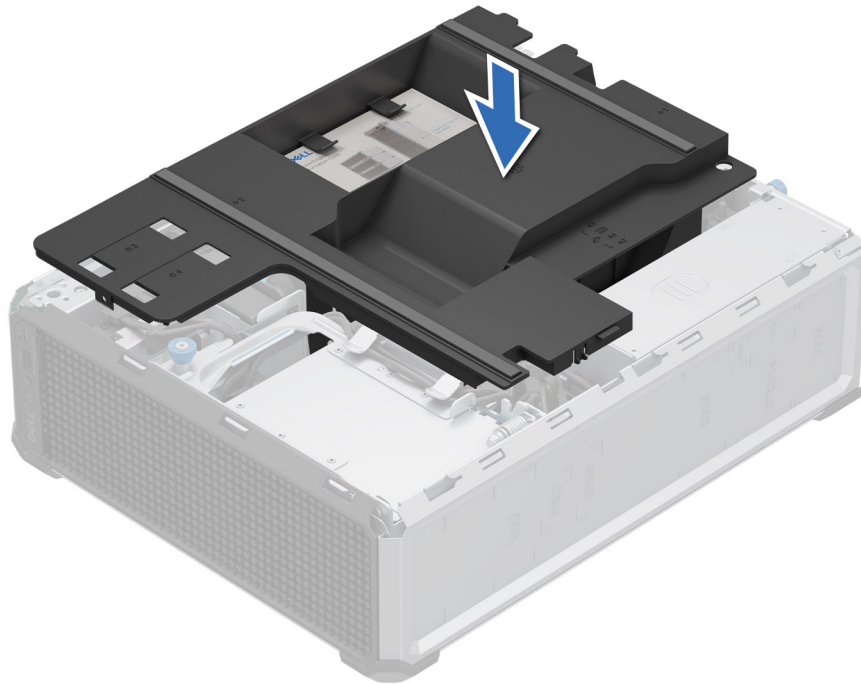

Figure 15. Installing the air shroud

### Next steps

Follow the procedure listed in [After working inside your system](#).

## Intrusion switch

This is a service technician replaceable part only.

### Removing the intrusion switch module

#### Prerequisites

1. Follow the safety guidelines listed in [Safety instructions](#).
2. Follow the procedure listed in [Before working inside your system](#).
3. [Remove the air shroud](#).

#### Steps

1. Disconnect the intrusion switch cable from the connector on the system board.

**i** **NOTE:** Observe the routing of the cable as you remove it from the system. Route the cable properly when you replace it to prevent the cable from being pinched or crimped.

2. Slide the intrusion switch module out of the system slot.

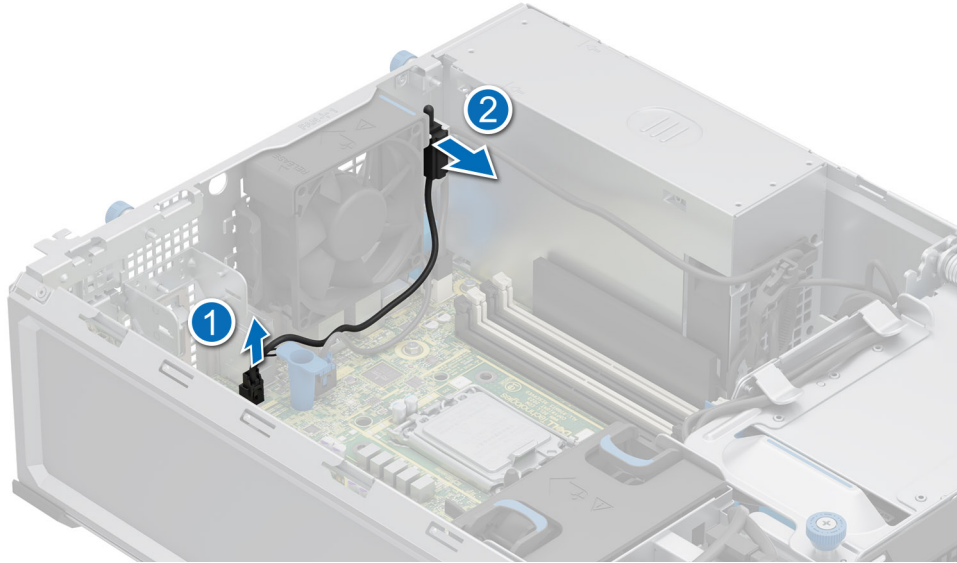

**Figure 16. Removing the intrusion switch module**

#### **Next steps**

Replace the intrusion switch module.

## **Installing the intrusion switch module**

#### **Prerequisites**

1. Follow the safety guidelines listed in [Safety instructions](#).
2. Follow the procedure listed in [Before working inside your system](#).

#### **Steps**

1. Align and slide the intrusion switch module into the system slot until firmly seated.
2. Connect the intrusion switch cable to the connector on the system board.

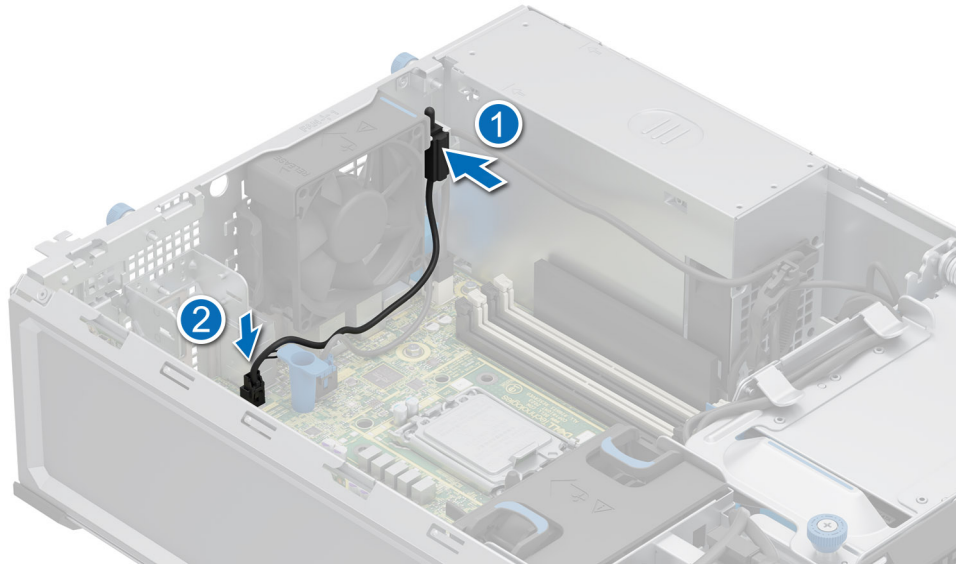

Figure 17. Installing the intrusion switch module

#### Next steps

1. [Install the air shroud.](#)
2. Follow the procedure that is listed in [After working inside your system.](#)

## Drives

### Removing the drive from the drive cage

#### Prerequisites

1. Follow the safety guidelines listed in [Safety instructions.](#)
2. Follow the procedure that is listed in [Before working inside your system.](#)
3. [Remove the air shroud.](#)
4. Disconnect the power and data cables from the drives in the drive cage.
5. Using the management software, prepare the drive for removal. If the drive is online, the green activity or fault indicator flashes while the drive is turning off. When the drive indicators are off, the drive is ready for removal. For more information, see the storage controller documentation.

**CAUTION:** Before attempting to remove or install a drive while the system is running, see the documentation for the storage controller card to ensure that the host adapter is configured correctly to support drive removal and insertion.

**CAUTION:** To prevent data loss, ensure that your operating system supports drive installation. See the documentation supplied with your operating system.

#### Steps

1. Loosen the captive screws on the drive cage.
2. Rotate out the 3.5-inch HDD cage.
3. Press the retention clips and lift the drive carrier from the drive bay.



**Figure 18. Removing a drive from drive cage**

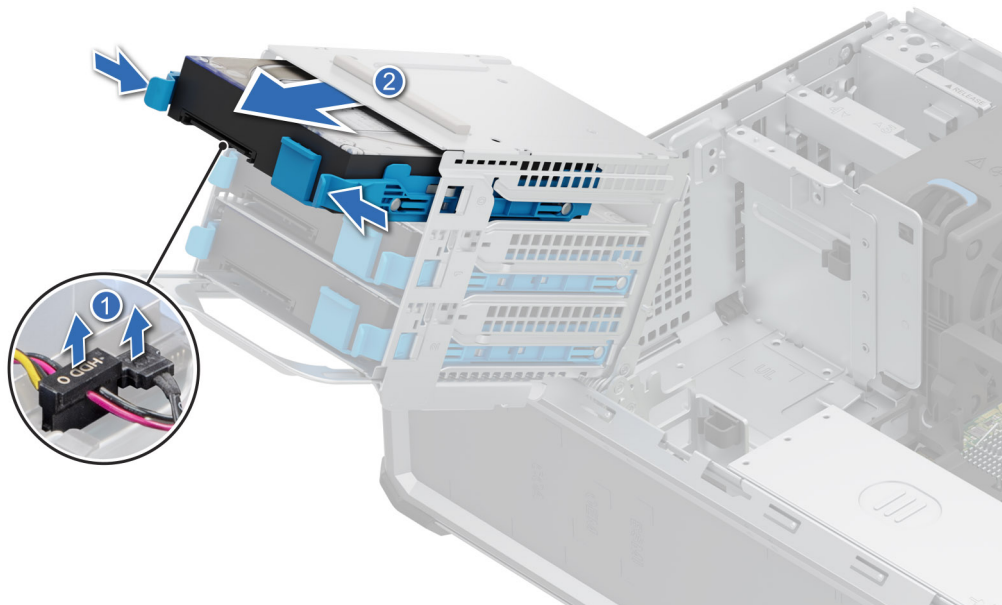

**Figure 19. Removing the drive from the drive cage**

4. For the 2.5-inch drive cage, press the retention clips and lift the drive carrier from the drive bay.



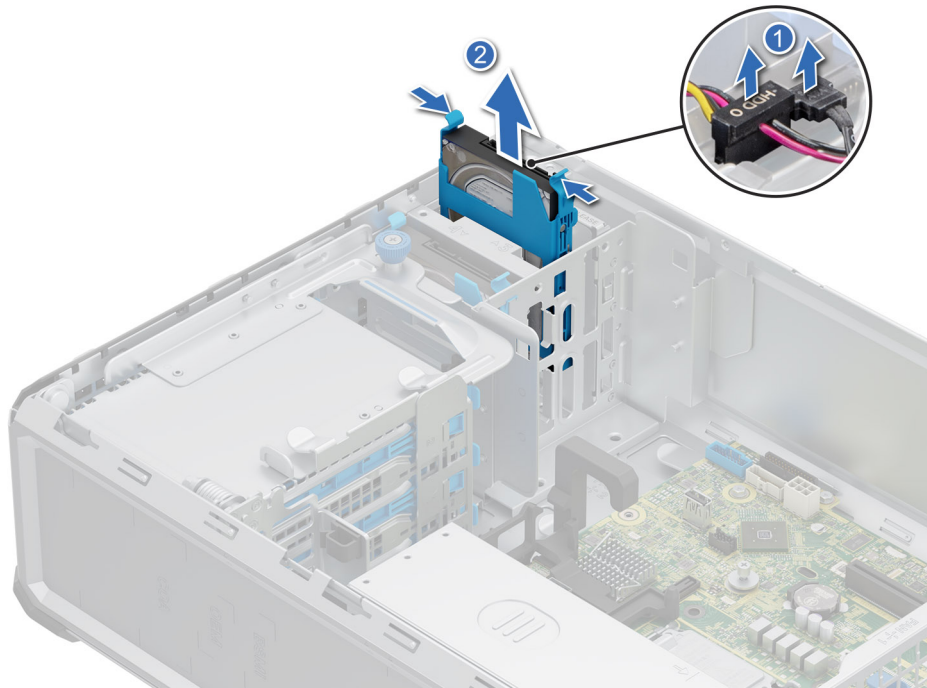

Figure 20. Removing the drive from the drive cage

#### Next steps

Replace the drives in the drive cage.

## Installing the drive carrier

#### Prerequisites

**CAUTION:** Combining SAS and SATA drives in the same RAID volume is not supported.

**CAUTION:** When installing a drive, ensure that the adjacent drives are fully installed. Inserting a drive carrier and attempting to lock its handle next to a partially installed carrier can damage the partially installed carrier's shield spring and make it unusable.

**NOTE:** Ensure that the drive carrier's release handle is in the open position before inserting the carrier into the slot.

1. Follow the safety guidelines listed in [Safety instructions](#).
2. Follow the procedure that is listed in [Before working inside your system](#).
3. [Remove the air shroud](#).
4. Remove the drive carrier or remove the drive blank when you want to assemble the drives in to the system.

#### Steps

1. Align and slide the drive carrier into the drive bay until it clicks into place.
2. Rotate back the HDD cage to the chassis and tighten captive screws on the drive cage.

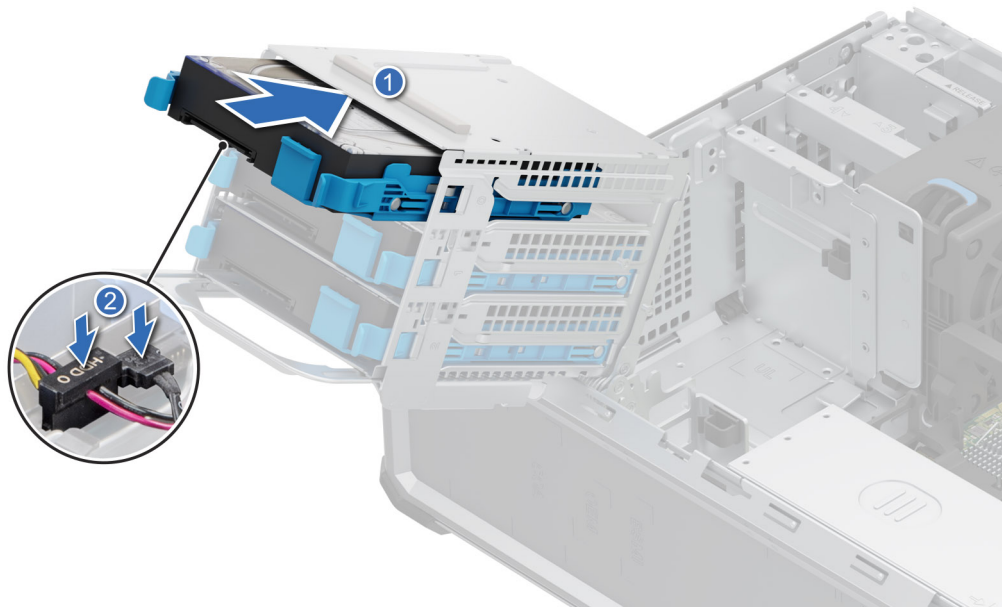

Figure 21. Installing a drive carrier

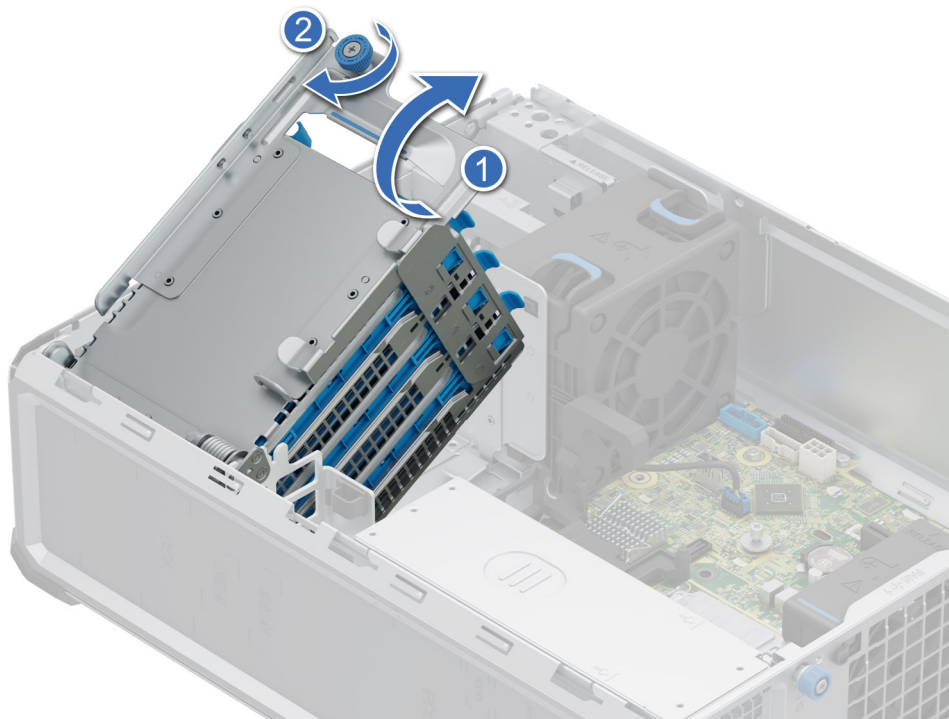
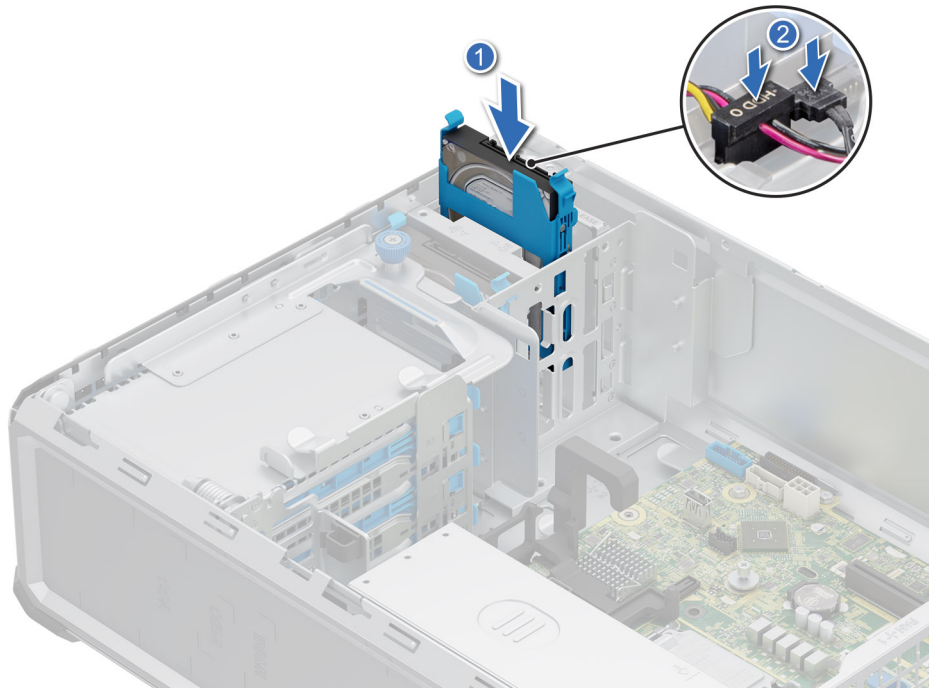

Figure 22. Installing a drive carrier



**Figure 23. Installing a drive carrier**

### **Next steps**

Install the air shroud.

## **Removing the drive from the drive carrier**

### **Prerequisites**

1. Follow the safety guidelines listed in [Safety instructions](#).
2. Follow the procedure that is listed in [Before working inside your system](#).
3. [Remove the drive from the drive cage](#).

### **Steps**

Flex the drive bracket and remove the drive from the carrier.



**Figure 24. Removing the drive from the drive carrier**

#### **Next steps**

1. [Replace the drive into the drive carrier.](#)

## **Installing the drive into the drive carrier**

#### **Prerequisites**

1. Follow the safety guidelines listed in [Safety instructions](#).
2. Follow the procedure that is listed in [Before working inside your system](#) .

#### **Steps**

1. Align the guide pins on the drive with the screws holes on the drive carrier.
2. Flex the side of the drive carrier, and place the drive into the drive carrier.

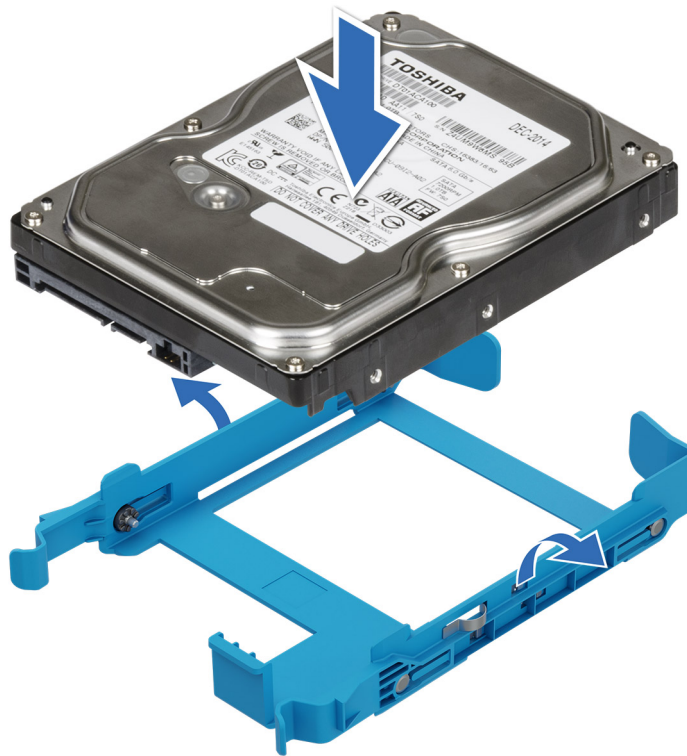

Figure 25. Installing a drive into the drive carrier

#### Next steps

1. [Install the drive carrier.](#)
2. Follow the procedure listed in [After working inside your system.](#)

## Cooling fans

### Removing the cooling fan

#### Prerequisites

**CAUTION:** Never operate your system with the fan removed. The system can overheat and result in the shutdown of the system and loss of data.

1. Follow the safety guidelines listed in [Safety instructions.](#)
2. Follow the procedure listed in [Before working inside your system.](#)
3. [Remove the air shroud.](#)

#### Steps

1. Disconnect the fan cable from the connector on the system board.
2. Holding the fan, press the side release tab, and slide the fan in the direction of the arrow that is marked on the fan to remove it from the system.

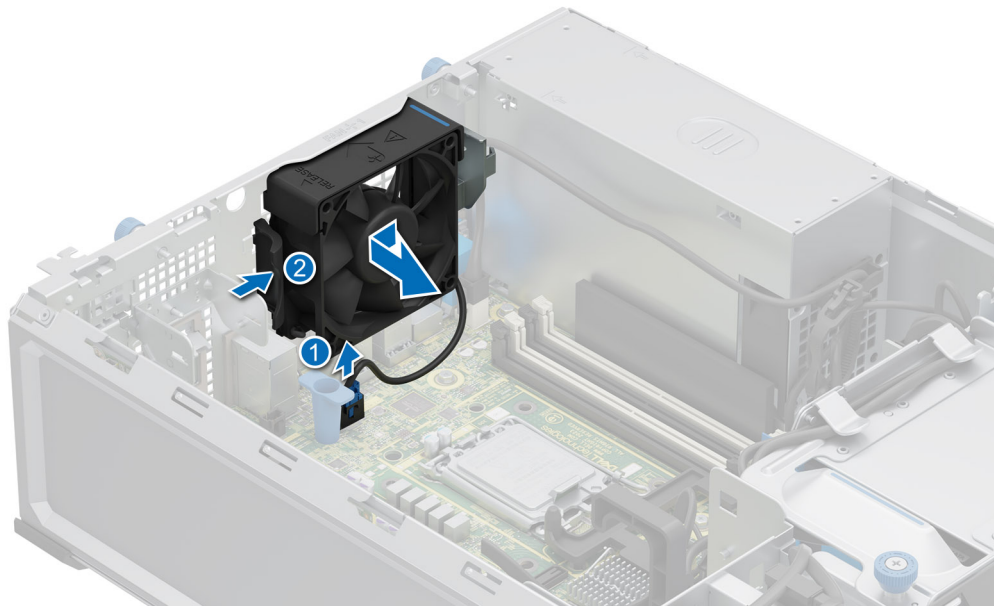

Figure 26. Removing the cooling fan

 **CAUTION:** Do not remove or install the fan by holding the fan blades.

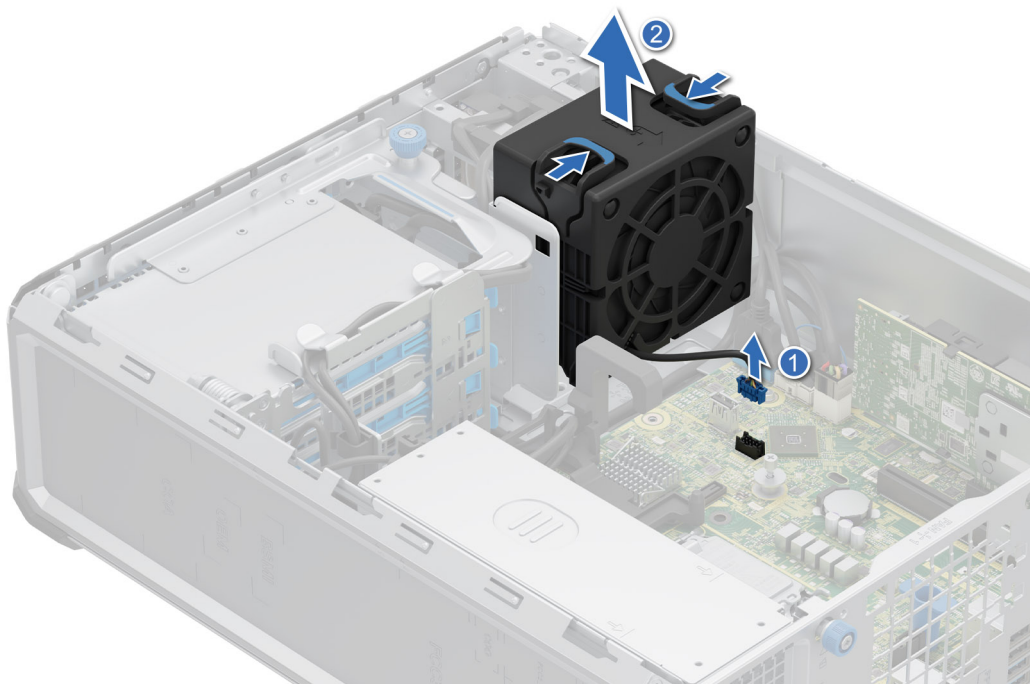

Figure 27. Removing the High Performance (HPR) PCI fan

If a BOSS or a PCIe card is installed or a 2.5 inch drive is installed in the 2.5 inch drive bay, an HPR PCI fan is needed for all the configurations.

#### Next steps

1. [Replace the cooling fan.](#)

## Installing the cooling fan

### Prerequisites

1. Follow the safety guidelines listed in [Safety instructions](#).
2. Follow the procedure listed in [Before working inside your system](#).
3. [Remove the air shroud](#).

### Steps

1. Align the four tabs on the fan with the four slots on the system wall.
2. Press and slide the fan into the slot until the release tab locks into place.
3. Connect the fan cable to the connector on the system board.

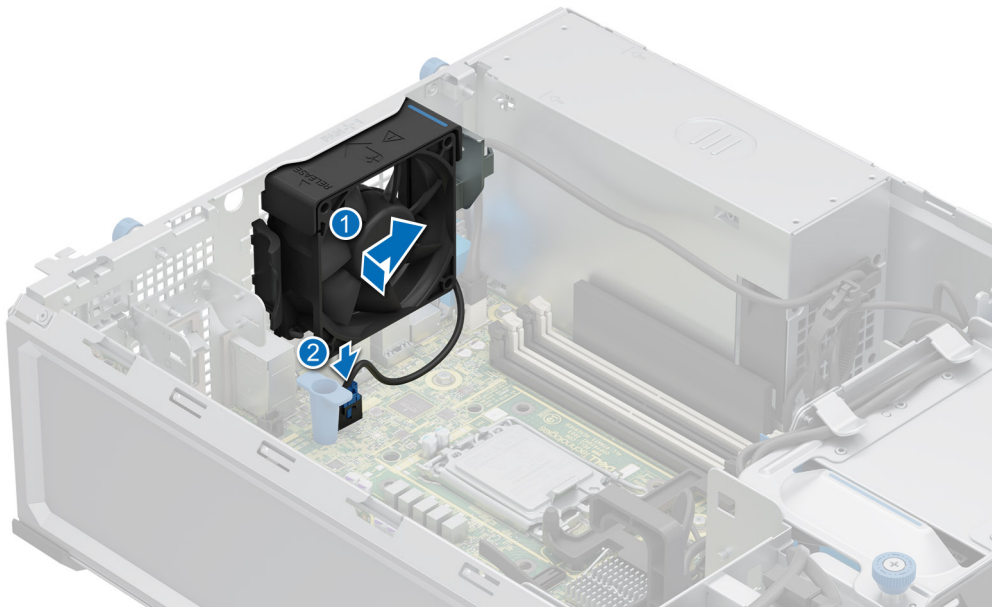
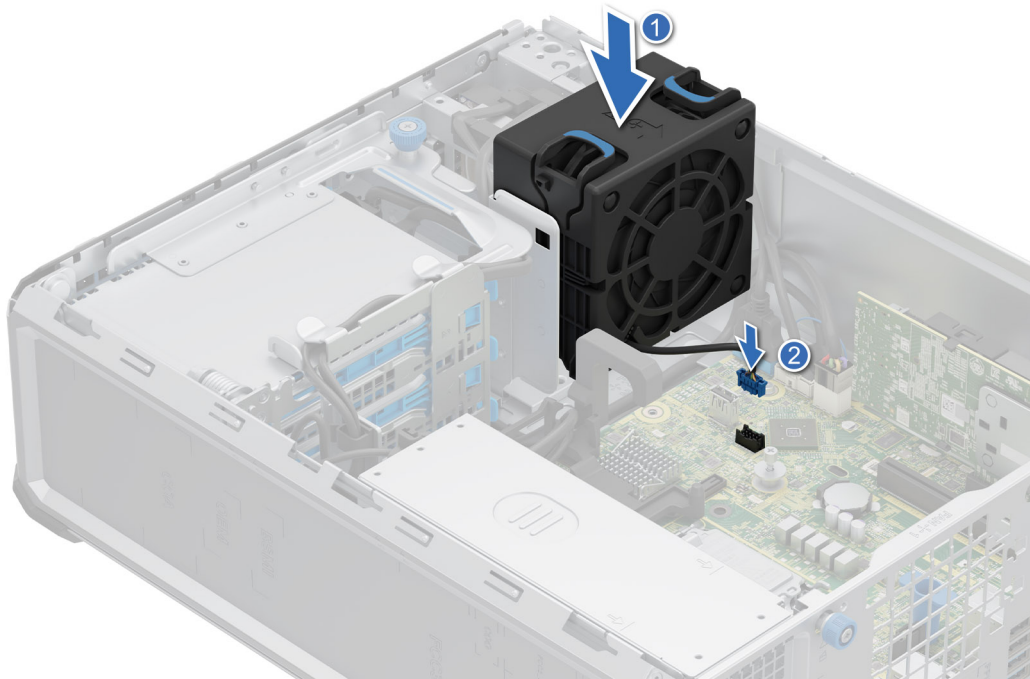

Figure 28. Installing the cooling fan



**Figure 29. Installing the High Performance (HPR) PCI fan**

If a BOSS or a PCIe card is installed or a 2.5 inch drive is installed in the 2.5 inch drive bay, an HPR PCI fan is needed for all the configurations.

**Next steps**

1. [Install the air shroud.](#)
2. Follow the procedure listed in [After working inside your system.](#)



# Cable routing

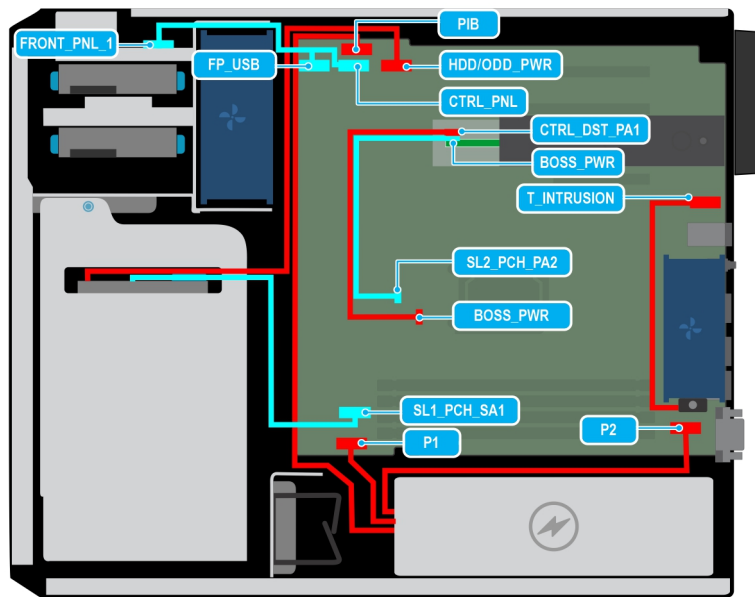

Figure 30. Cable routing - 3 x 3.5 inch Chip SATA

Table 57. Connector descriptions for a 3 x 3.5 inch Chip SATA

From	To
MB_FP_USB (front USB connector on system board) and CTRL_PNL (control panel connector on system board)	FIO (control panel connector)
MB_T_INTRUSION (INTRUSION connector on system board)	INTRUSION
MB_SL1_PCH_SA1 (signal connector on system board)	HDD0, HDD1, HDD2 (signal connector connecting through the drives 0, 1, 2)
MB_PIB (power interposer board connector on system board) and MB_P1 (system power connector on system board)	PSU (Power supply unit)
MB_HDD/ODD_PWR (Drives/Optical disc drive power connector on the system board)	HDD0, HDD1, HDD2 (connecting through the drives 0, 1, 2)
MB_SL2_PCH_PA2 (signal connector on the system board)	BOSS_CTRL_DST_PA1 (BOSS input connector)
MB_BOSS_PWR (power connector on system board)	BOSS_PWR (BOSS module power connector)

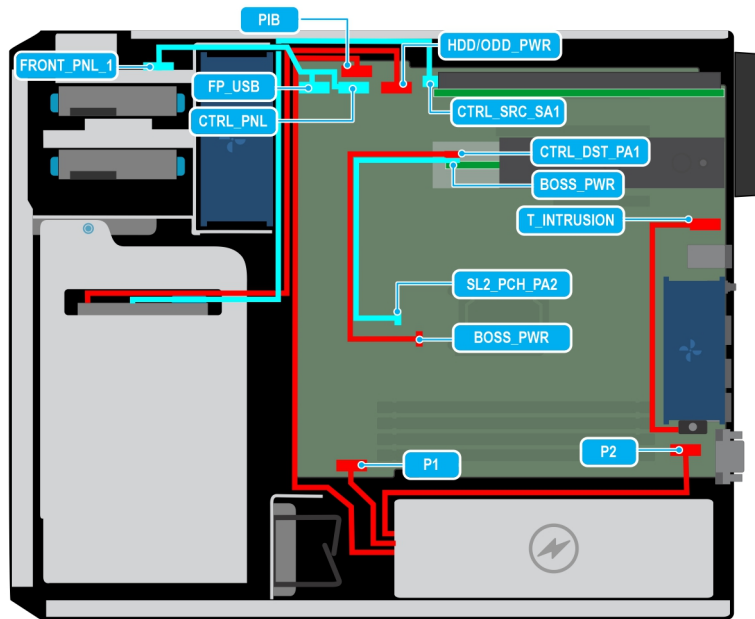

Figure 31. Cable routing - 3 x 3.5 inch PERC SATA

Table 58. Connector descriptions for 3 x 3.5 inch PERC SATA

From	To
MB_FP_USB (front USB connector on system board) and CTRL_PNL (control panel connector on system board)	FIO (control panel connector)
MB_T_INTRUSION (INTRUSION connector on system board)	INTRUSION
MB_HDD/ODD_PWR (Drives/Optical disc drive power connector on the system board) and PERC_CTRL_SRC_SA1 (Signal connector on the PERC)	HDD0, HDD1, HDD2 (connecting through the drives 0, 1, 2)
MB_PIB (power interposer board connector on system board) and MB_P1 (system power connector on system board)	PSU (power supply unit)
MB_SL2_PCH_PA2 (signal connector on the system board)	BOSS_CTRL_DST_PA1 (BOSS input connector)
MB_BOSS_PWR (power connector on system board)	BOSS_PWR (BOSS module power connector)

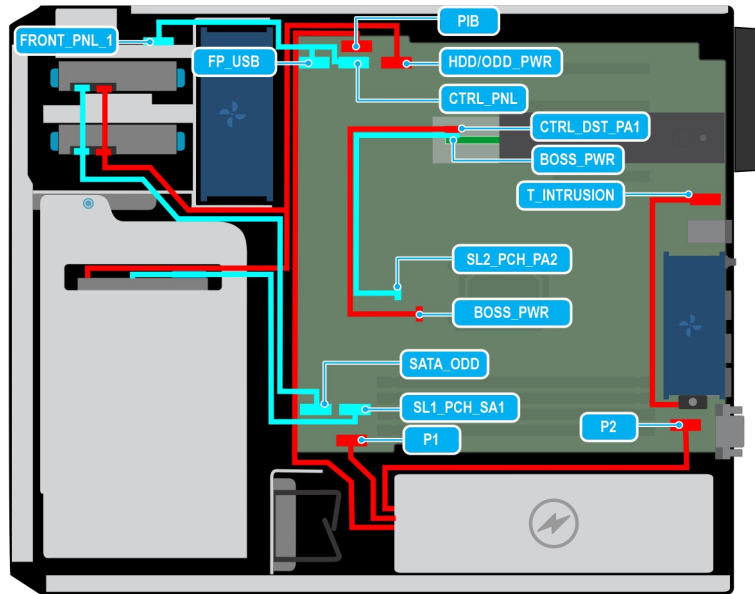
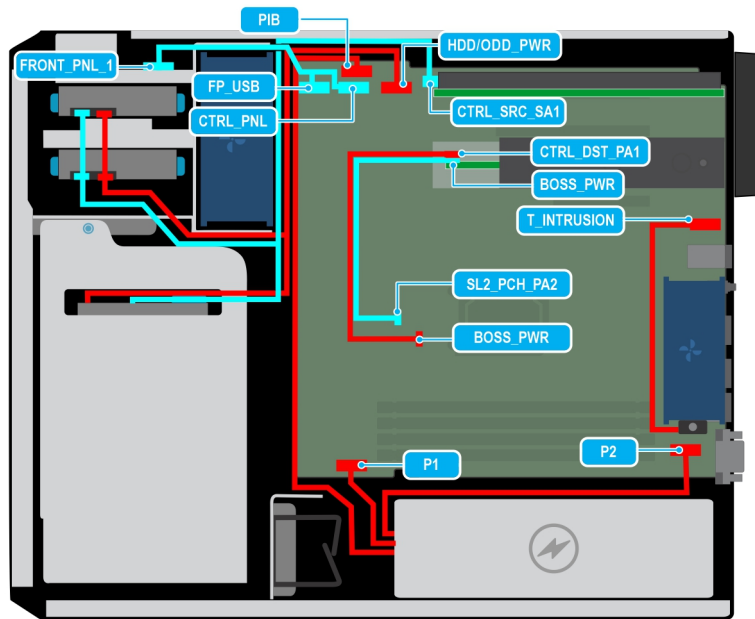

Figure 32. Cable routing - 3 x 3.5 inch + 2 x 2.5 inch Chip SATA

Table 59. Connector descriptions for 3 x 3.5 inch + 2 x 2.5 inch Chip SATA

From	To
MB_FP_USB (front USB connector on system board) and CTRL_PNL (control panel connector on system board)	FIO (control panel connector)
MB_SL1_PCH_SA1 (signal connector on system board) and MB_SATA_ODD (optical disc drive SATA connector on system board)	HDD0, HDD1, HDD2, HDD3, HDD4 (signal connector connecting through the drives 0, 1, 2, 3, 4)
MB_HDD/ODD_PWR (Drives/Optical disc drive power connector on the system board)	HDD0, HDD1, HDD2, HDD3, HDD4 (Connecting through the drives 0, 1, 2, 3, 4)
MB_T_INTRUSION (INTRUSION connector on system board)	INTRUSION
MB_PIB (power interposer board connector on system board) and MB_P1 (system power connector on system board)	PSU (power supply unit)
MB_SL2_PCH_PA2 (signal connector on the system board)	BOSS_CTRL_DST_PA1 (BOSS input connector)
MB_BOSS_PWR (power connector on system board)	BOSS_PWR (BOSS module power connector)



**Figure 33. Cable routing - 3 x 3.5 inch + 2 x 2.5 inch PERC SATA**

**Table 60. Connector descriptions for 3 x 3.5 inch + 2 x 2.5 inch with PERC SATA**

From	To
MB_FP_USB (front USB connector on system board) and CTRL_PNL (control panel connector on system board)	FIO (control panel connector)
MB_HDD/ODD_PWR (Drives/Optical disc drive power connector on the system board) and PERC_CTRL_SRC_SA1 (Signal connector on the PERC)	HDD0, HDD1, HDD2, HDD3, HDD4 (connecting through the drives 0, 1, 2, 3, 4)
MB_T_INTRUSION (INTRUSION connector on system board)	INTRUSION
MB_PIB (power interposer board connector on system board) and MB_P1 (system power connector on system board)	PSU (power supply unit)
MB_SL2_PCH_PA2 (signal connector on the system board)	BOSS_CTRL_DST_PA1 (BOSS input connector)
MB_BOSS_PWR (power connector on system board)	BOSS_PWR (BOSS module power connector)

## System memory

### System memory guidelines

The PowerEdge T160 system supports DDR5 ECC unbuffered DIMMs (UDIMMs).

Your system memory is organized into two channels per processor (two memory sockets per channel), four memory sockets per system.

Memory channels are organized as follows:

**Table 61. Memory channels**

Processor	Channel A	Channel B
Processor 1	A1, A3	A2, A4

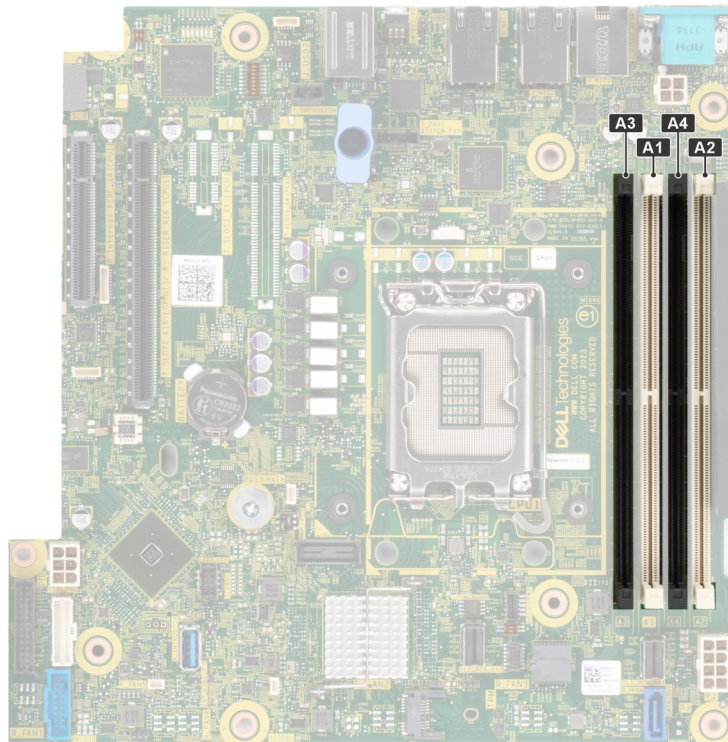

**Figure 34. Memory socket location**

**Table 62. Supported memory matrix**

DIMM type	Rank	Capacity	DIMM rated voltage and speed	Operating Speed	
				1 DIMM per channel (DPC)	2 DIMM per channel (DPC)
ECC UDIMM	1 R	16 GB	DDR5 (1.1 V), 4800 MT/s, or 5600 MT/s	4400 MT/s	4000 MT/s
	2 R	32 GB	DDR5 (1.1 V), 4800 MT/s, or 5600 MT/s	4400 MT/s	3600 MT/s

**NOTE:** The processor may reduce the performance of the rated DIMM speed.

## General memory module installation guidelines

To ensure optimal performance of your system, observe the following general guidelines when configuring your system memory. If your system's memory configuration fails to observe these guidelines, your system might not boot, stop responding during memory configuration, or operate with reduced memory.

The memory bus may operate at speeds of 4400 MT/s, 4000 MT/s, or 3600 MT/s depending on the following factors:

- System profile selected (for example, Performance, Performance Per Watt Optimized (OS), or Custom [can be run at high speed or lower])
- Maximum supported DIMM speed of the processors
- Maximum supported speed of the DIMMs

**NOTE:** MT/s indicates DIMM speed in Mega-Transfers per second.

The following are the recommended guidelines for installing memory modules:

- All DIMMs must be DDR5.
- DIMM mixing configurations is not supported. All DIMM slots must be populated with the exact same DIMMs.

- If memory modules with different speeds are installed, they operate at the speed of the slowest installed memory module(s).
- Populate memory module sockets only if a processor is installed.
  - For single-processor systems, sockets A1 to A4 are available.
  - A minimum of 1 DIMM must be populated for the installed processor.
- In **Optimizer Mode**, the DRAM controllers operate independently in the 64-bit mode and provide optimized memory performance.
- Populate all the sockets with white release tabs first.
- Unbalanced memory configurations result in a performance loss. Always populate memory channels identically with equal DIMMs for the best performance.
- Refer to the following table for the population matrix.

**Table 63. Memory population rules**

Processor	Memory population	Memory population information
Single processor	A{1}, A{2}, A{3}, A{4}	1, 2, 3, 4 DIMMs are allowed.

**NOTE:** Equal memory modules refer to DIMMs with identical electrical specification and capacity that may be from different vendors.

**Table 64. Table showing supported DIMM population**

Configuration	Number of DIMMs	Channel A		Channel B		Status	Speed Up to (in MT/s)
		A3	A1	A4	A2		
1	1	-	-	-	1	Supported	4400
2	2	-	-	1	1	Supported	4400
3	1	-	1	-	-	Supported - Best Performance	4400
4	2	-	1	-	1	Supported - Best Performance	4400
5	3	-	1	1	1	Supported	4400
6	2	1	1	-	-	Supported	4400
7	3	1	1	-	1	Supported	4400
8	4	1	1	1	1	Supported - Best Performance	4400

## Removing a memory module

### Prerequisites

1. Follow the safety guidelines listed in the [Safety instructions](#).
2. Follow the procedure listed in [Before working inside your system](#).
3. [Remove the air shroud](#).

**WARNING:** The memory modules are hot to touch for some time after the system has been powered off. Allow the memory modules to cool before handling them.

**NOTE:** To ensure proper system cooling, memory module blanks must be installed in any memory socket that is not occupied. Remove the memory module blanks only if you intend to install memory modules in these sockets.

### Steps

1. Locate the appropriate memory module socket.
2. To release the memory module from the socket, simultaneously press the ejectors on both ends of the memory module socket to fully open.

**CAUTION:** Handle each memory module only by the card edges, ensuring not to touch the middle of the memory module or metallic contacts.

3. Lift the memory module away from the system.

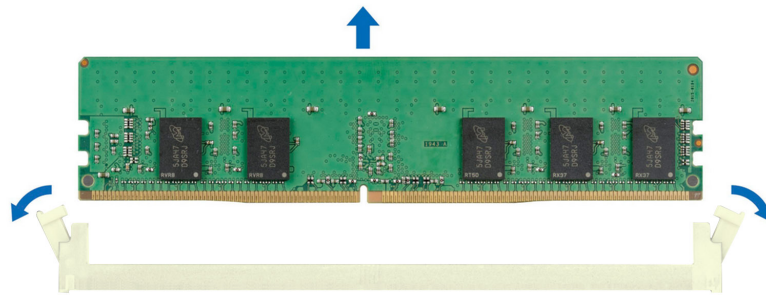

Figure 35. Removing a memory module

### Next steps

Replace the memory module.

## Installing a memory module

### Prerequisites

1. Follow the safety guidelines listed in the [Safety instructions](#).
2. Follow the procedure listed in [Before working inside your system](#).
3. [Remove the air shroud](#).

### Steps

1. Locate the appropriate memory module socket.

**CAUTION:** Handle each memory module only by the card edges, ensuring not to touch the middle of the memory module or metallic contacts.

**NOTE:** Ensure that the socket ejector latches are fully open before installing the memory module.

2. Align the edge connector of the memory module with the alignment key of the memory module socket, and insert the memory module in the socket.

**CAUTION:** To prevent damage to the memory module or the memory module socket during installation, do not bend or flex the memory module; insert both ends of the memory module simultaneously.

**NOTE:** The memory module socket has an alignment key that enables you to install the memory module in the socket in only one orientation.

**CAUTION:** Do not apply pressure at the center of the memory module; apply pressure at both ends of the memory module evenly.

3. Press the memory module with your thumbs until the ejectors firmly click into place. When the memory module is properly seated in the socket, the levers on the memory module socket align with the levers on the other sockets that have memory modules that are installed.

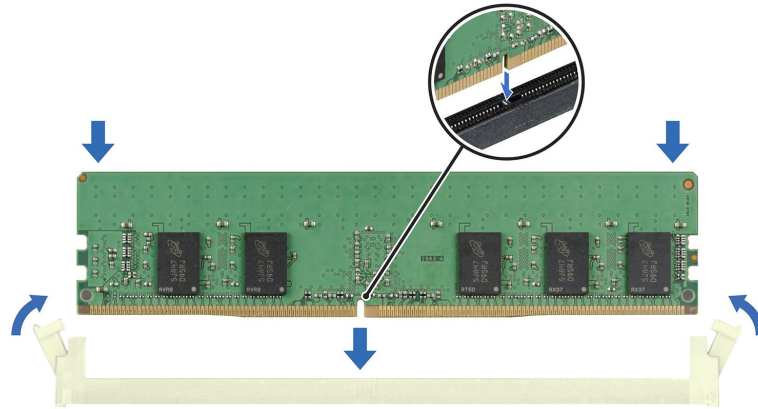

**Figure 36. Installing a memory module**

#### Next steps

1. [Install the air shroud.](#)
2. Follow the procedure listed in [After working inside your system.](#)
3. To verify that the memory module has been installed properly, press F2 during reboot and navigate to **System Setup Main Menu > System BIOS > Memory Settings**. In the **Memory Settings** screen, the System Memory Size must reflect the updated capacity of the installed memory.
4. If the System Memory Size is incorrect, one or more of the memory modules may not be installed properly. Shut down the system and ensure that the memory modules are firmly seated in the correct sockets.
5. Run the system memory test in system diagnostics.

## Processor and heat sink module

This is a service technician replaceable part only.

### Removing the heat sink

#### Prerequisites

**⚠ WARNING:** The heat sink may be hot to touch for some time after the system has been powered off. Allow the heat sink to cool before removing it.

1. Follow the safety guidelines listed in the [Safety instructions](#).
2. Follow the procedure listed in [Before working inside your system](#).
3. [Remove the air shroud.](#)

#### Steps

1. Using a Phillips 2 screwdriver, loosen the captive screws on the heat sink in the order mentioned below:
  - a. Loosen the first captive screw three turns.
  - b. Loosen the captive screw diagonally opposite to the screw you loosened first.
  - c. Repeat the procedure for the remaining two captive screws.
  - d. Return to the first screw to loosen it completely.
2. Lift the heat sink away from the system.



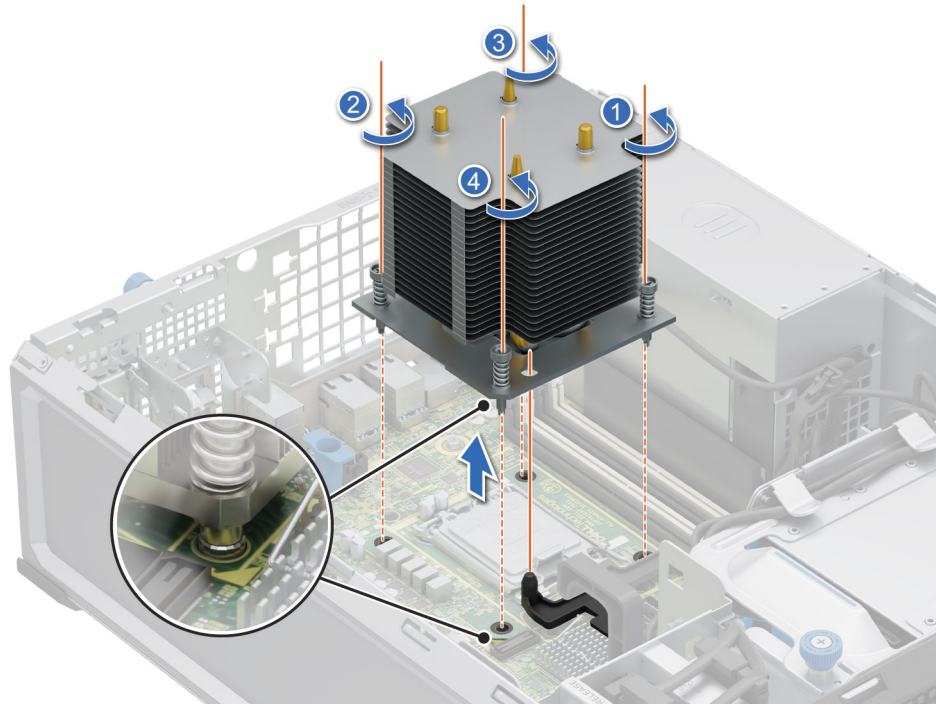

Figure 37. Removing the heat sink

### Next steps

Replace the heat sink.

## Removing the processor

### Prerequisites

**WARNING:** The processor will be hot to touch for some time after the system has been powered off. Allow the processor to cool before removing it.

**CAUTION:** The processor is held in its socket under strong pressure. Be aware that the release lever can spring up suddenly if not firmly held.

**NOTE:** Only remove the processor if you are replacing the processor or system board. This procedure is not required when replacing a heat sink module.

1. Follow the safety guidelines listed in the [Safety instructions](#).
2. Follow the procedure listed in [Before working inside your system](#).
3. [Remove the heat sink module](#).

### Steps

1. Release the socket lever by pushing the lever down and out from under the tab on the processor shield.
2. Lift the lever upward until the processor shield lifts.

**CAUTION:** The processor socket pins are fragile and can be permanently damaged. Be careful not to bend the pins in the processor socket when removing the processor out of the socket.

3. Lift the processor out of the socket.

**NOTE:** Ensure that the processor and the bracket are placed in the tray after you remove the heat sink.

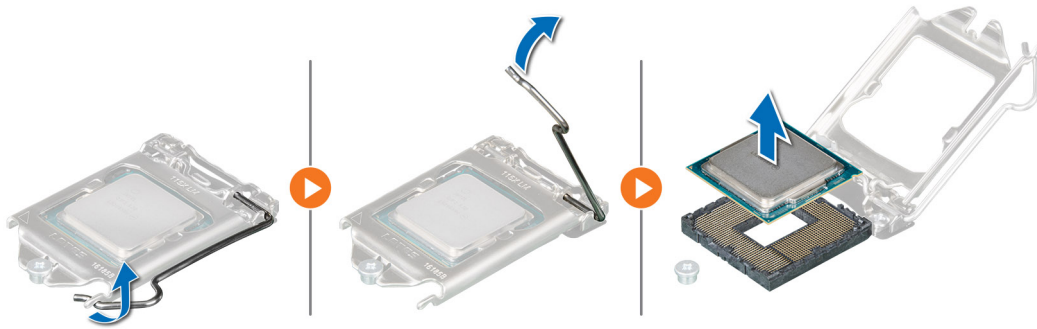

Figure 38. Removing the processor

**Next steps**

Replace the processor.

## Installing the processor

**Prerequisites**

**CAUTION:** Never remove the heat sink from a processor unless you intend to replace the processor. The heat sink is necessary to maintain proper thermal conditions.

1. Follow the safety guidelines listed in the [Safety instructions](#).
2. Follow the procedure listed in [Before working inside your system](#).
3. [Remove the processor](#).

**Steps**

1. Align the pin 1 indicator of the processor with the triangle on the socket and place the processor on the socket.

**CAUTION:** Positioning the processor incorrectly can permanently damage the system board or the processor. Be careful not to bend the pins in the socket.

2. Lower the socket lever and push it under the tab to lock it.

**NOTE:** If the processor has previously been used in a system, remove any remaining thermal grease from the processor by using a lint-free cloth.

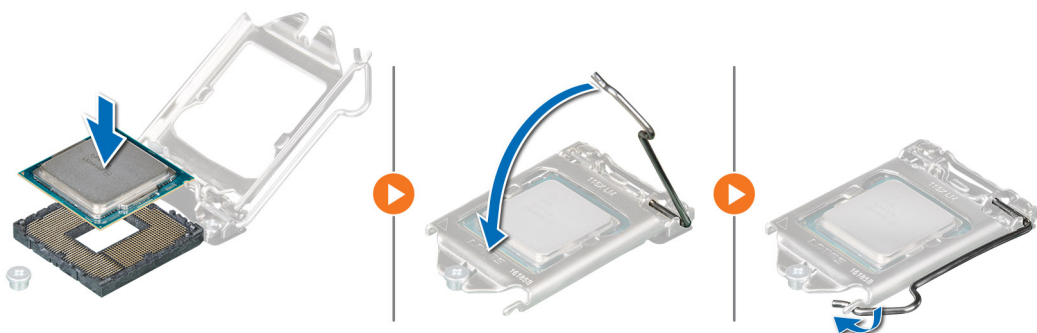

Figure 39. Installing the processor

## Next steps

**i** **NOTE:** Ensure that you install the heat sink after you install the processor. The heat sink is necessary to maintain proper thermal conditions.

1. Install the heat sink module.
2. Follow the procedure listed in [After working inside your system](#).

## Installing the heat sink

### Prerequisites

**△** **CAUTION:** Never remove the heat sink from a processor unless you intend to replace the processor. The heat sink is necessary to maintain proper thermal conditions.

1. Follow the safety guidelines listed in the [Safety instructions](#).
2. Follow the procedure listed in [Before working inside your system](#).
3. If removed, [install the processor](#).

### Steps

1. If you are using an existing heat sink, remove the thermal grease from the heat sink by using a clean lint-free cloth.
2. Apply thermal grease in a quadrilateral design on the top of the processor.

**△** **CAUTION:** Applying too much thermal grease can result in excess grease coming in contact with and contaminating the processor socket.

**i** **NOTE:** The thermal grease syringe is intended for single use only. Dispose the syringe after you use it.

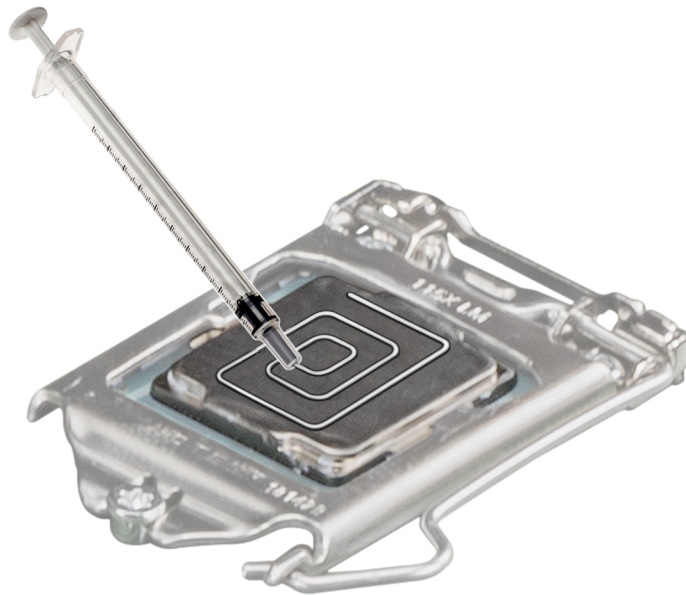

**Figure 40. Applying thermal grease on top of the processor**

3. Align the captive screws on the heat sink with the hole on the system board.
4. Using the Phillips 2 screwdriver, tighten the captive screws on the heat sink in the order below:
  - a. In a random order, tighten the captive screws three turns.
  - b. Tighten the captive screw diagonally opposite to the screw that you tighten first.
  - c. Repeat the procedure for the remaining two captive screws.
  - d. Return to the first screw to tighten it completely.
  - e. Check all the captive screws to ensure they are firmly secured.

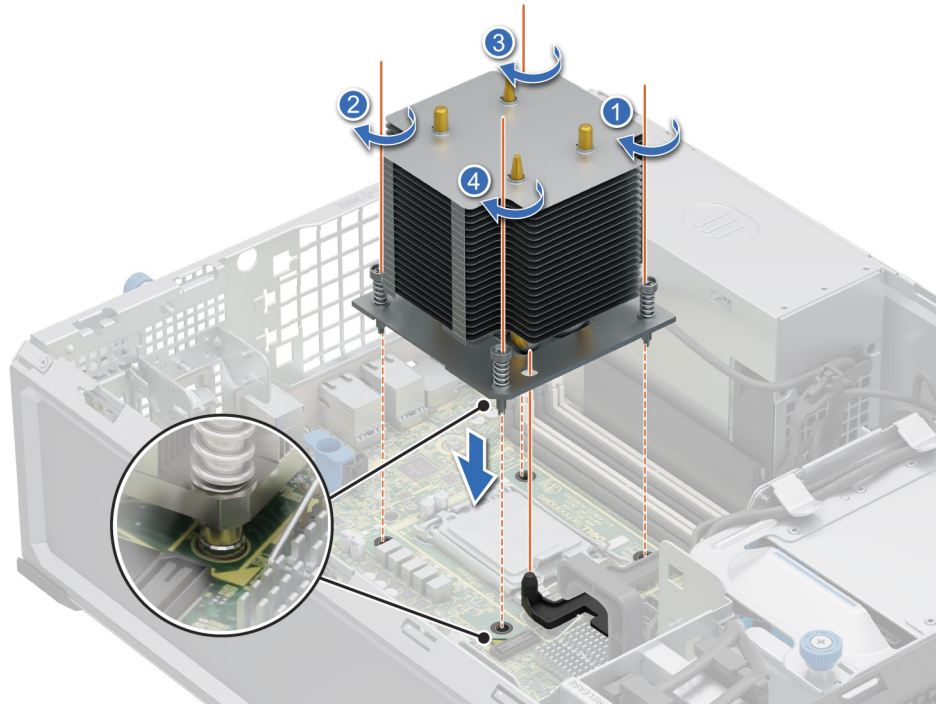

Figure 41. Installing the heat sink

#### Next steps

1. Install the air shroud.
2. Follow the procedure listed in [After working inside your system](#).
3. While booting, press **F2** to enter **System Setup** and check that the processor information matches the new system configuration.
4. Run the system diagnostics to verify that the new processor operates correctly.

## Expansion cards and expansion card risers

**NOTE:** When an expansion card is not supported or missing, the iDRAC and Lifecycle Controller logs an event. This does not prevent your system from booting. However, if a F1/F2 pause occurs with an error message, see [Troubleshooting expansion cards](#) section in the [PowerEdge Servers Troubleshooting Guide](#) at [PowerEdge Manuals](#).

### Expansion card installation guidelines

The following table describes the supported expansion cards and riser configurations:

The T160 has a no riser option. Shown below are the PCIe slot offerings for the platform.

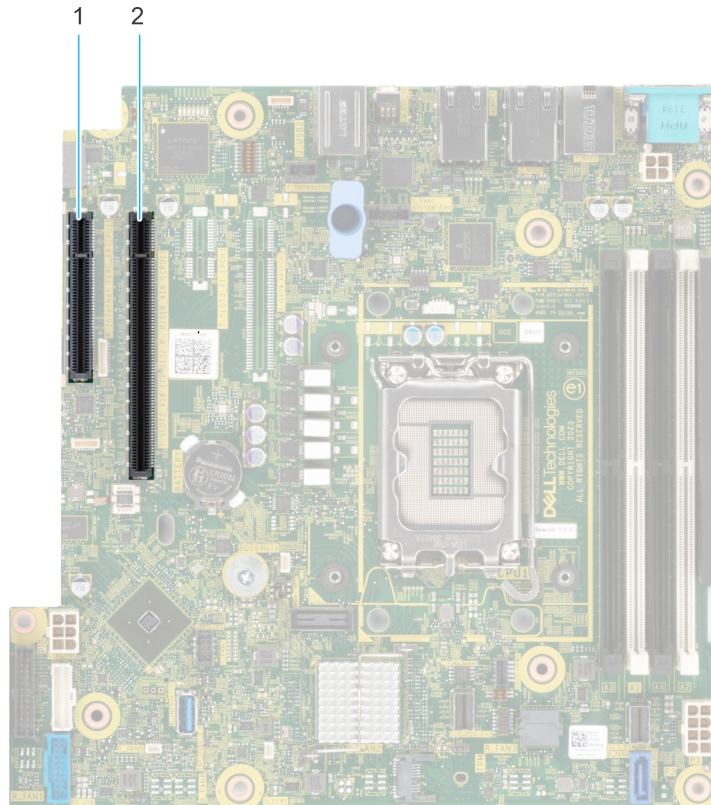

**Figure 42. PCIe connector slots on system board**

1. PCIe Slot 1 (CPU 1)
2. PCIe Slot 2 (CPU 1)

**Table 65. PCIe Riser Configurations**

Config No.	Riser configuration	No. of Processors	PERC type supported	Rear storage possible
0	N/A	1	Adapter	No

**NOTE:** The expansion-card slots are not hot-swappable.

The following table provides guidelines for installing expansion cards to ensure proper cooling and mechanical fit. The expansion cards with the highest priority should be installed first using the slot priority indicated. All the other expansion cards should be installed in the card priority and slot priority order.

**Table 66. Configuration : No Riser**

Card type	Slot priority	Maximum number of cards
FOXCONN (aPERC 11)	2,1	1
FOXCONN (aPERC HBA11)	2,1	2
FOXCONN (External Adapter)	2,1	2
Intel (NIC:10Gb)	2,1	2
Broadcom (NIC:10Gb)	2,1	2
Intel (NIC:1Gb)	2,1	2
FOXCONN (BOSS-N1)	INT	1

## Removing an expansion card

### Prerequisites

1. Follow the safety guidelines listed in [Safety instructions](#).
2. Follow the procedure listed in [Before working inside your system](#).
3. [Remove the air shroud](#).
4. Disconnect any cables that are connected to the expansion card.

### Steps

1. Loosen the captive screw and tilt the metal bracket that holds the expansion cards.
2. Hold the expansion card by the edges, and pull the card up to remove it from the expansion card connector on the system board.

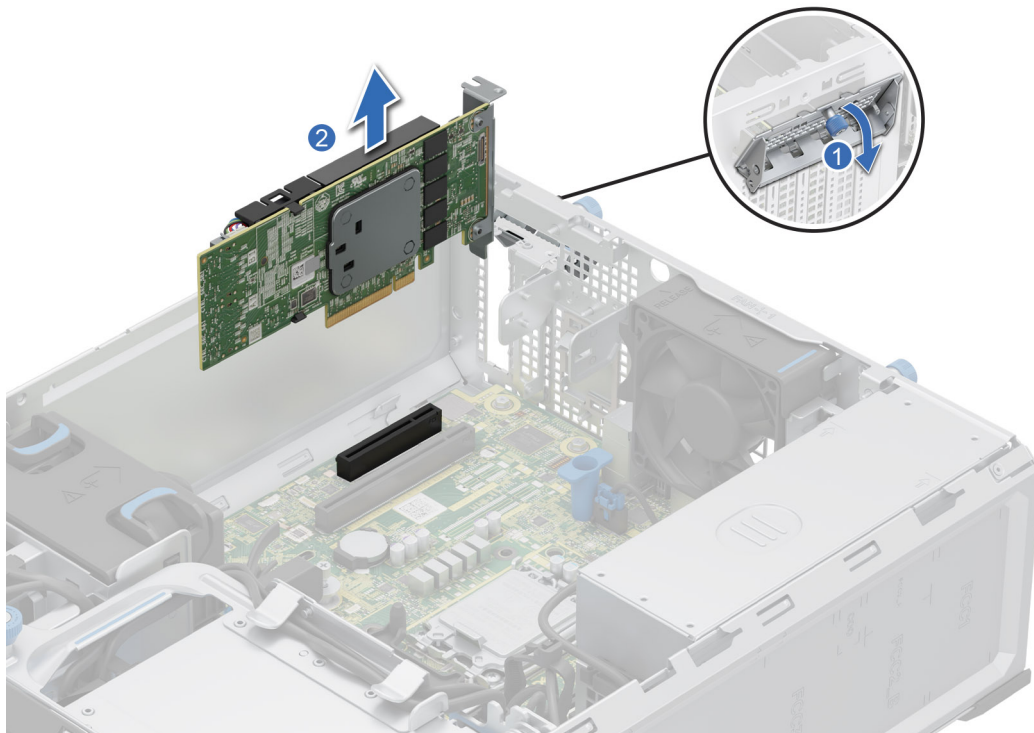

**Figure 43. Removing an expansion card**

3. If the expansion card is not going to be replaced, install metal filler.
4. Tilt the metal bracket and tighten the captive screw.

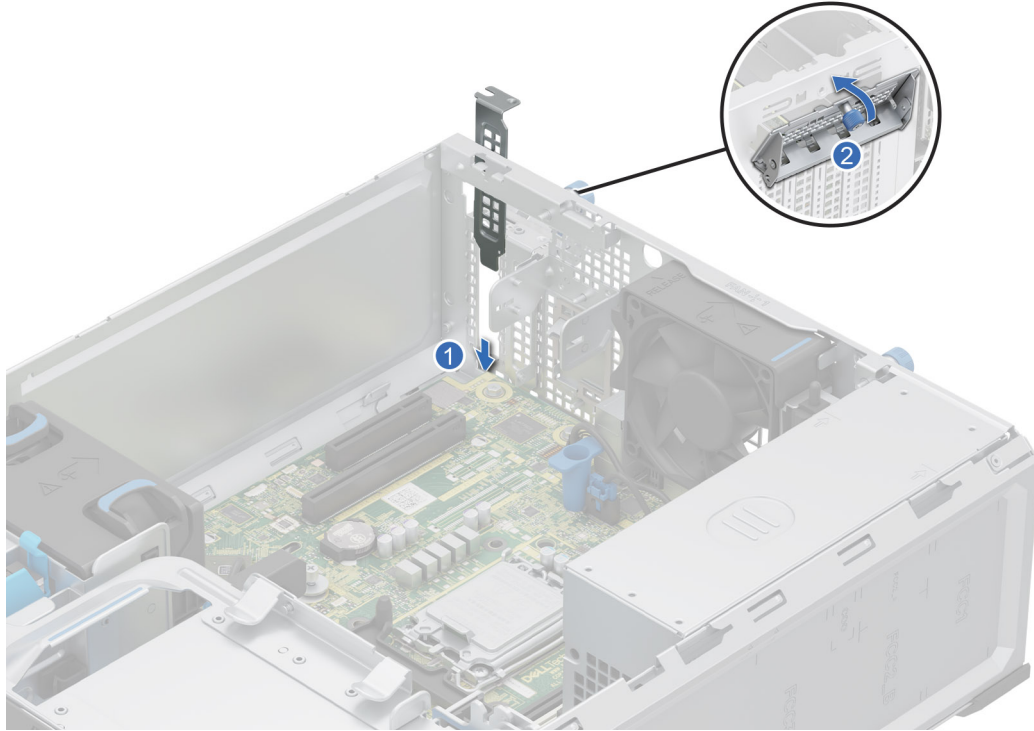

**Figure 44. Installing the metal filler**

**i** **NOTE:** Filler brackets must be installed in empty expansion-card slots to maintain FCC certification of the system. The brackets also keep dust and dirt out of the system and aid in proper cooling and airflow inside the system.

### Next steps

[Replace an expansion card.](#)

## Installing an expansion card

### Prerequisites

1. Follow the safety guidelines listed in [Safety instructions](#).
2. Follow the procedure listed in [Before working inside your system](#).
3. [Remove the air shroud](#).

### Steps

1. Loosen the captive screw and tilt the metal bracket that holds the metal filler.

**i** **NOTE:** Store this bracket for future use. Filler brackets must be installed in empty expansion-card slots to maintain FCC certification of the system. The brackets also keep dust and dirt out of the system and aid in proper cooling and airflow inside the system.

2. Lift the metal filler out of the system.

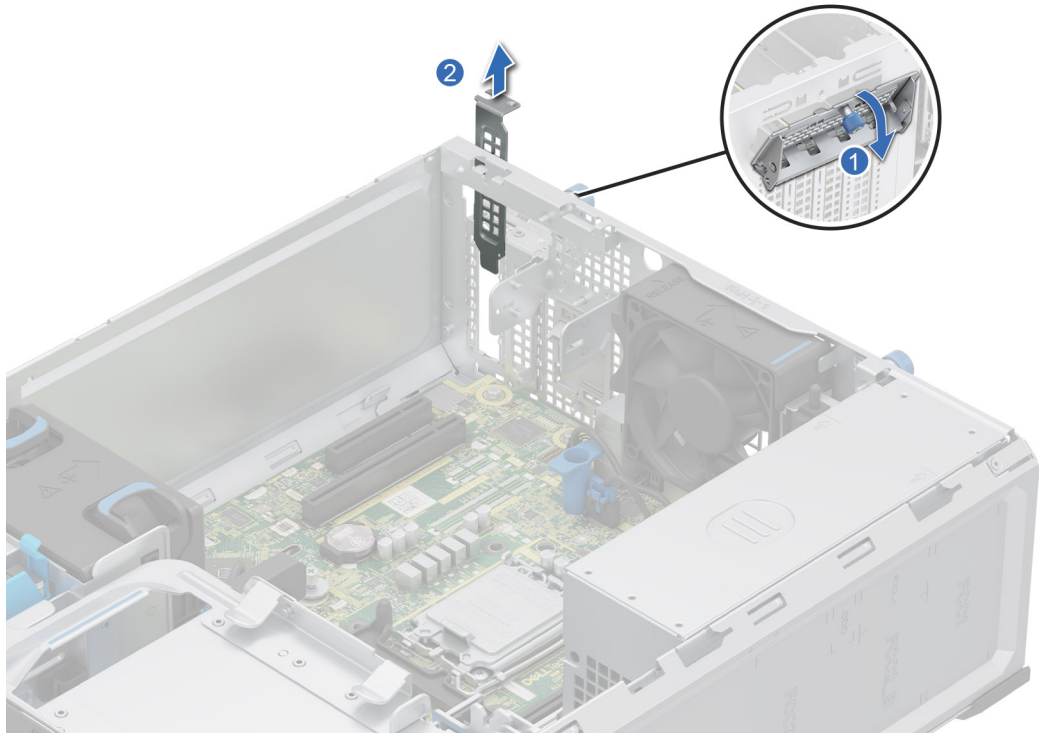

**Figure 45. Removing the metal filler**

3. Holding the card by the edges, align the card with the expansion card slot on the system board.
4. Insert the card firmly into the expansion card slot until the card is firmly seated.

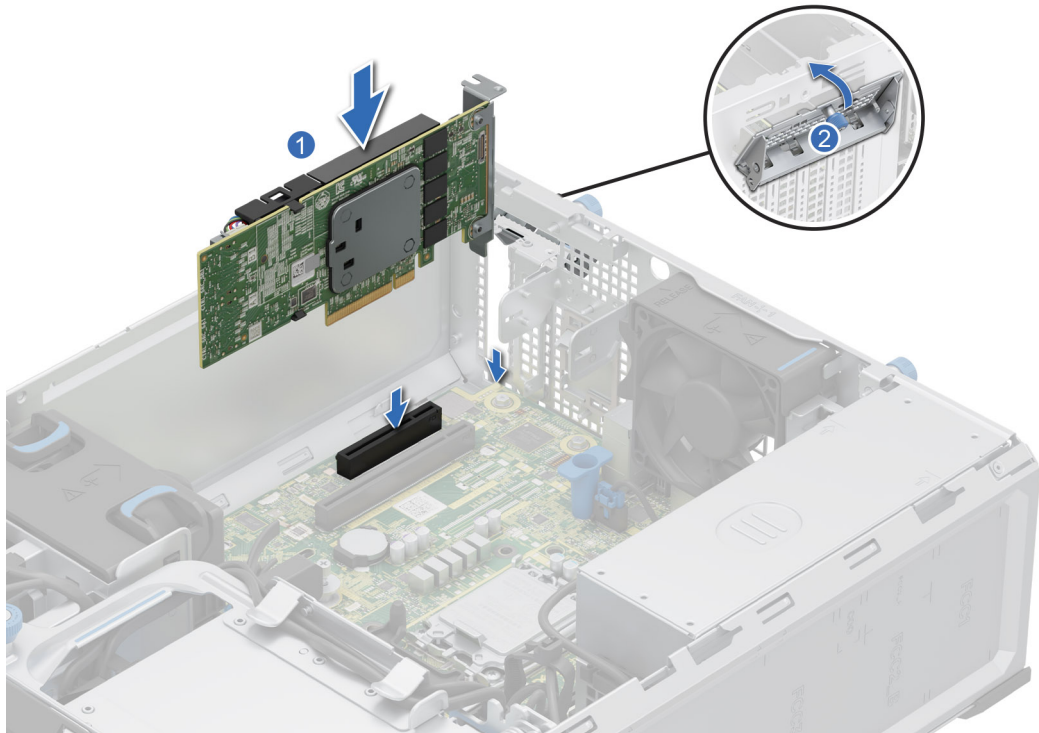

**Figure 46. Installing an expansion card**

5. Tilt the metal bracket and tighten the captive screw.



### Next steps

1. If required, reconnect the cables to the expansion card.
2. [Install the air shroud](#).
3. Follow the procedure listed in [After working inside your system](#).

## Optional BOSS-N1 module

### Removing the BOSS-N1 module

#### Prerequisites

1. Follow the safety guidelines listed in [Safety instructions](#).
2. Follow the procedure that is listed in [Before working inside your system](#).
3. [Remove the air shroud](#).

#### Steps

1. Disconnect the cables that are connected to the system board from the BOSS-N1 module.
2. Press the side release tab.
3. Slide the BOSS-N1 module out of the system.

 **NOTE:** The numbers on the image do not depict the exact steps. The numbers are for representation of sequence.

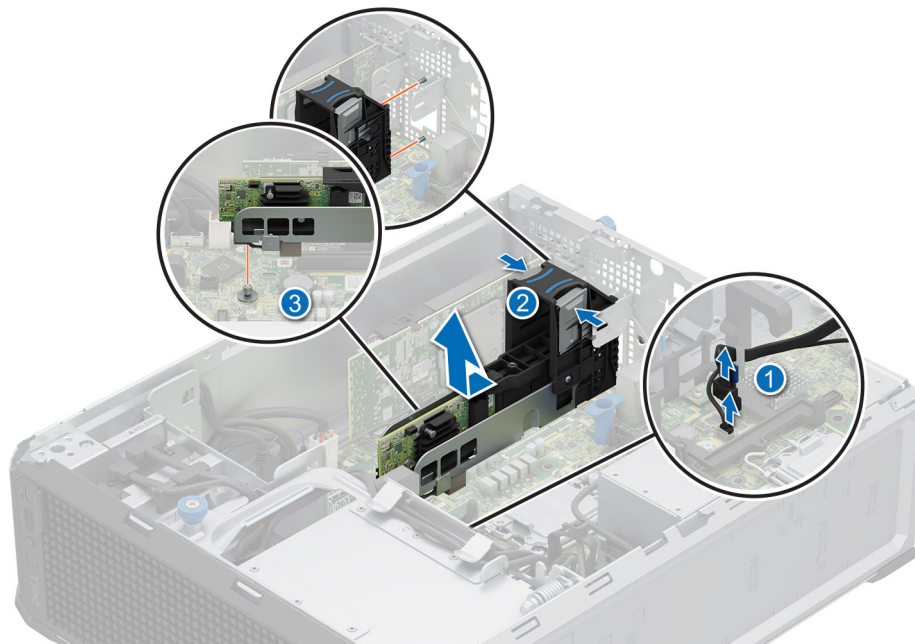

**Figure 47. Removing the BOSS-N1 module**

4. Align the blank with the BOSS-N1 module slot and push it into the bay until it clicks into place.

 **NOTE:** Blanks must be installed in empty slots to maintain FCC certification of the system. The blanks also keep dust and dirt out of the system and aid in proper cooling and airflow inside the system.

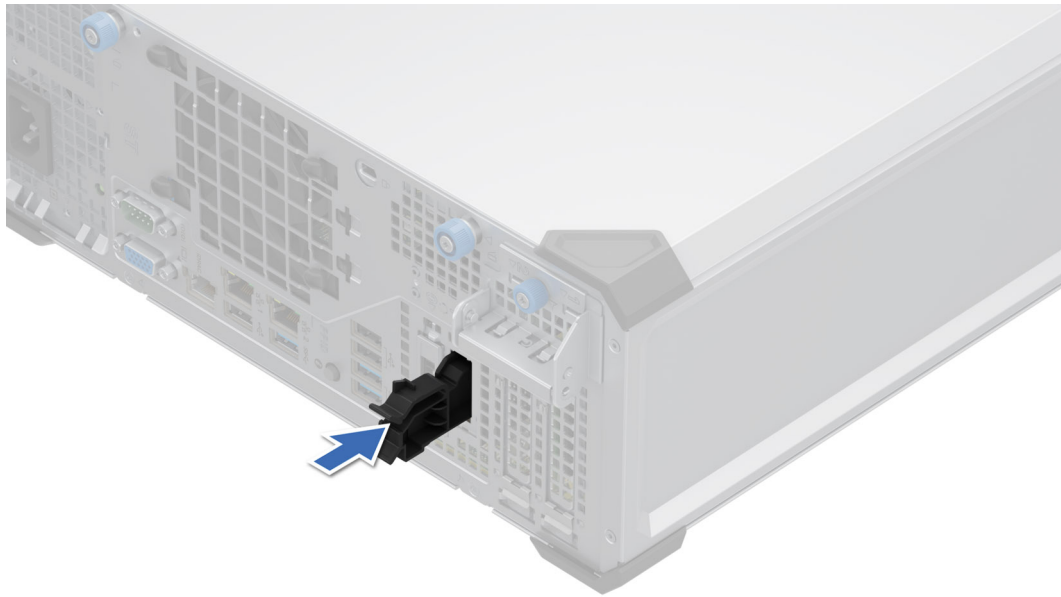

**Figure 48. Installing the BOSS-N1 module blank**

5. Using a Phillips 2 screwdriver, tighten the screw that secures the BOSS-N1 module blank to the system.

#### **Next steps**

[Replace the BOSS-N1 module.](#)

## **Installing the BOSS-N1 module**

#### **Prerequisites**

1. Follow the safety guidelines listed in [Safety instructions](#).
2. Follow the procedure that is listed in [Before working inside your system](#).
3. [Remove the air shroud](#).

#### **Steps**

1. Using a Phillips 2 screwdriver, remove the screw that secures the BOSS-N1 module blank from the system.
2. Slide out the BOSS-N1 module blank from the system using a flat head screwdriver.

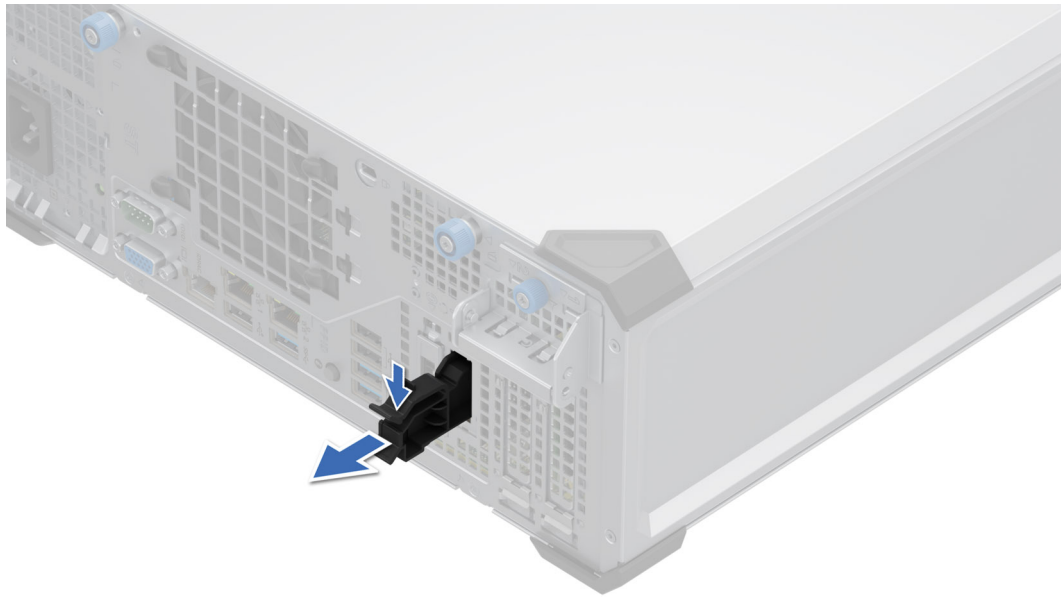

**Figure 49. Removing the BOSS-N1 module blank**

3. Align the BOSS-N1 module to the BOSS-N1 slot on the chassis and push it to secure into the slot.

**NOTE:** The numbers on the image do not depict the exact steps. The numbers are for representation of sequence.

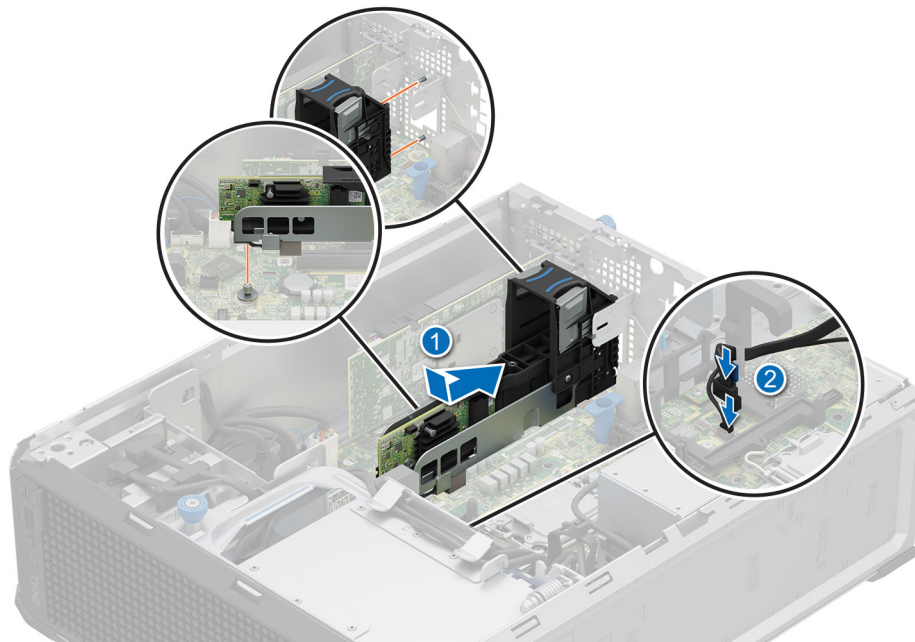

**Figure 50. Installing the BOSS-N1 module**

4. Connect the cables to the system board connectors.

**NOTE:** Route the cables properly to prevent them from being pinched or crimped.

#### Next steps

1. [Install the air shroud.](#)
2. Follow the procedure that is listed in [After working inside your system.](#)

# Removing the BOSS-N1 card carrier

## Prerequisites

1. Follow the safety guidelines listed in [Safety instructions](#).
2. Follow the procedure that is listed in [Before working inside your system](#).

## Steps

1. Open the release latch and slide the BOSS-N1 card carrier out of the BOSS-N1 module.

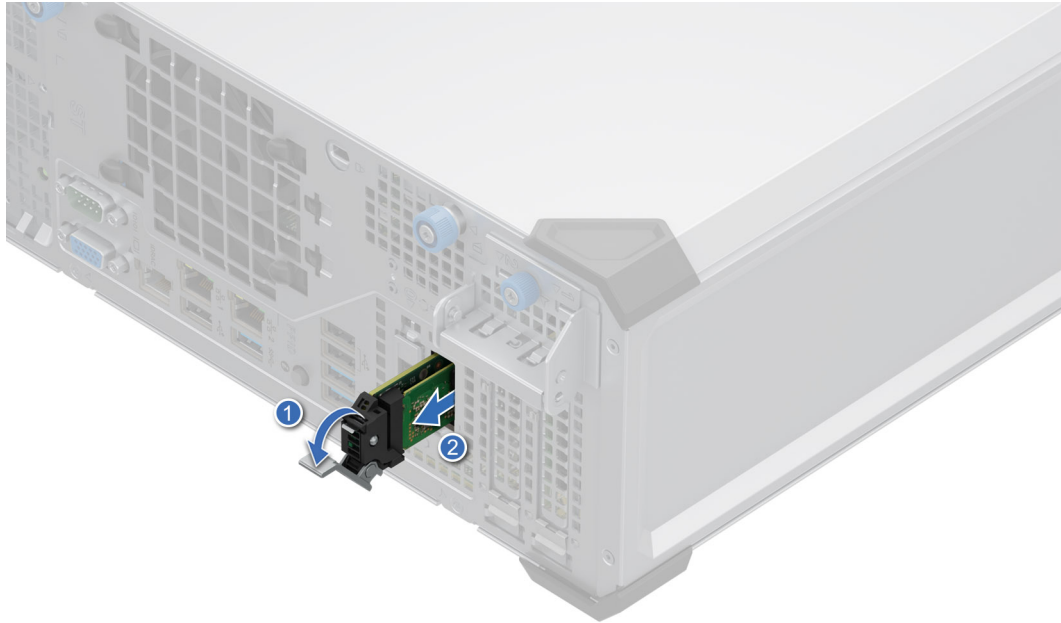

**Figure 51. Removing the BOSS-N1 card carrier**

2. Using the Phillips 1 screwdriver removes the M3 x 0.5 x 4.5 mm screw that secures the M.2 NVMe SSD to the BOSS-N1 card carrier.
3. Slide the M.2 NVMe SSD out from the BOSS-N1 card carrier.

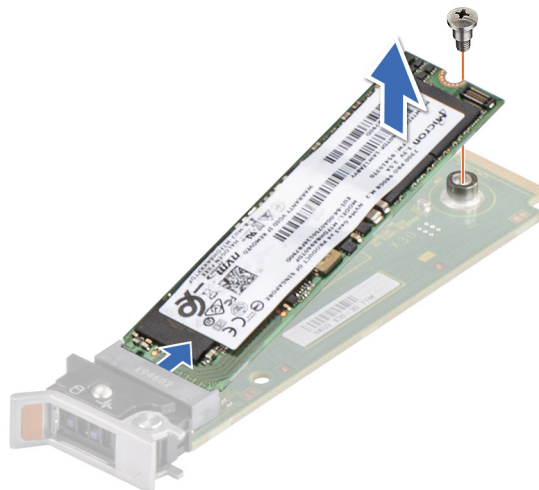

**Figure 52. Removing the M.2 NVMe SSD**

4. If not installing the BOSS-N1 card carrier, align and push the BOSS-N1 card carrier blank into the BOSS-N1 module to fill the empty BOSS-N1 card carrier slot.

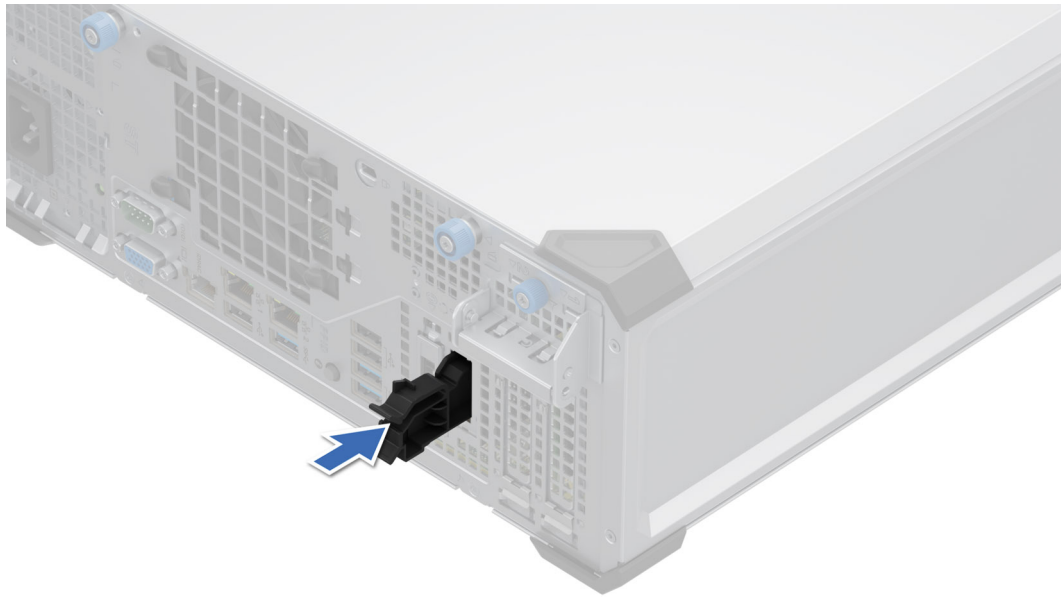

**Figure 53. Installing the BOSS-N1 card carrier blank**

#### **Next steps**

Replace the BOSS-N1 module

## **Installing the BOSS-N1 card carrier**

#### **Prerequisites**

1. Follow the safety guidelines listed in [Safety instructions](#) .
2. Follow the procedure that is listed in [Before working inside your system](#) .

#### **Steps**

1. Press the release clip and pull the BOSS-N1 card carrier blank out of the system.

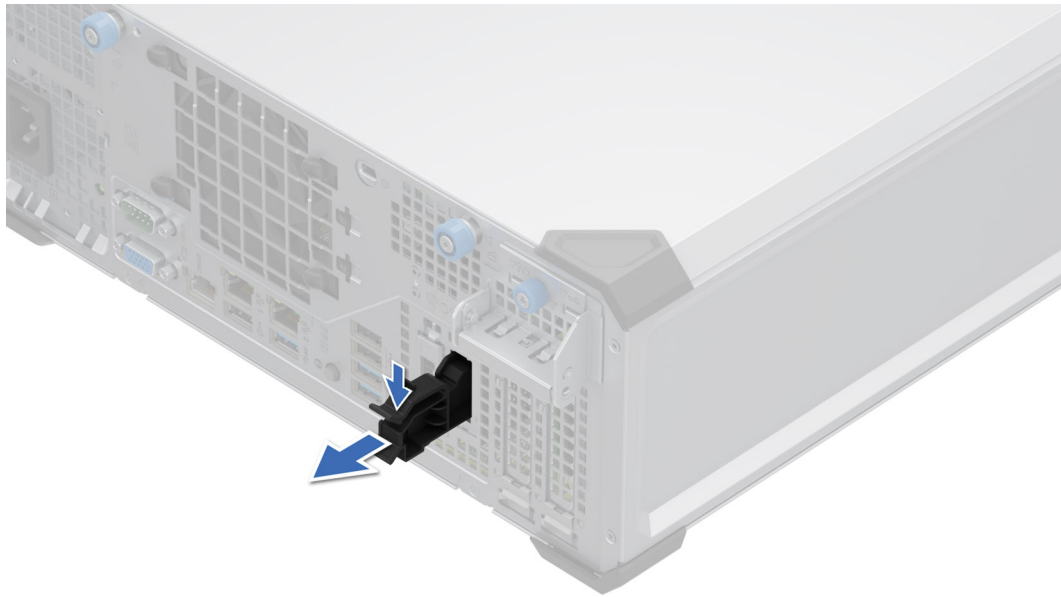

**Figure 54. Removing the BOSS-N1 card carrier blank**

2. Align the M.2 NVMe SSD at an angle with the BOSS-N1 card carrier.
3. Insert the M.2 NVMe SSD until it is firmly seated in the BOSS-N1 card carrier.
4. Using the Phillips 1 screwdriver, secure the M.2 NVMe SSD on the BOSS-N1 card carrier with the M3 x 0.5 x 4.5 mm screw.

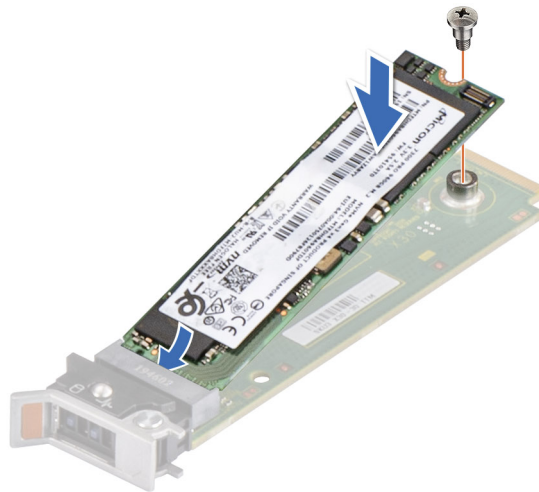

**Figure 55. Installing the M.2 NVMe SSD**

5. Align and push the BOSS-N1 card carrier into the slot in the BOSS-N1 module.
6. Close the release latch to secure the BOSS-N1 card carrier.

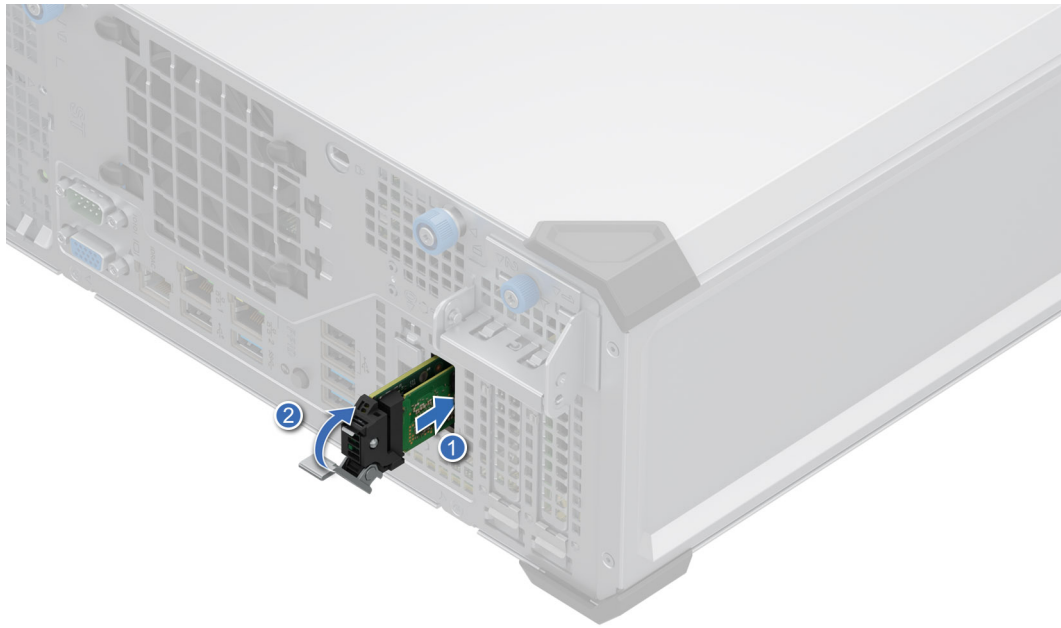

**Figure 56. Installing the BOSS-N1 card carrier**

#### Next steps

1. Follow the procedure that is listed in [After working inside your system](#).

## Power supply unit

**NOTE:** While replacing the hot swappable PSU, after next server boot; the new PSU automatically updates to the same firmware and configuration of the replaced one. For updating to the latest firmware and changing the configuration, see the *Lifecycle Controller User's Guide* at [iDRAC Manuals](#).

## Removing the cabled PSU

#### Prerequisites

1. Follow the safety guidelines listed in [Safety instructions](#).
2. Follow the procedure listed in [Before working inside your system](#).
3. Disconnect the power cables of the PSU from the system board.
4. Remove the cables from the cable clip.

#### Steps

1. Using a Phillips 2 screwdriver, remove the screws that secure the PSU to the system.
2. Slide and lift the PSU toward the front of the system.

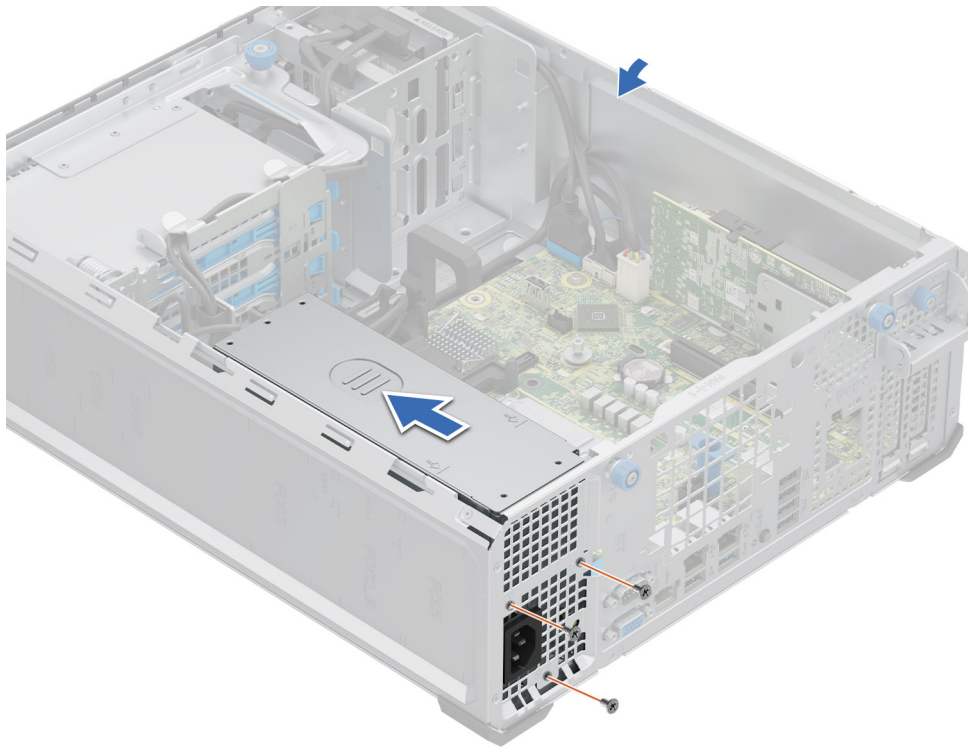

**Figure 57. Removing the cabled PSU**

#### **Next steps**

1. [Replace the cabled PSU.](#)

## **Installing the cabled PSU**

#### **Prerequisites**

1. Follow the safety guidelines listed in [Safety instructions](#).
2. Unpack the replacement PSU.

#### **Steps**

1. Tilt at an angle and insert the PSU into the slots on the system then slide it towards the rear of the system until the PSU is fully seated.
2. Using the Phillips 2 screwdriver, tighten the screws that secure the PSU to the system.



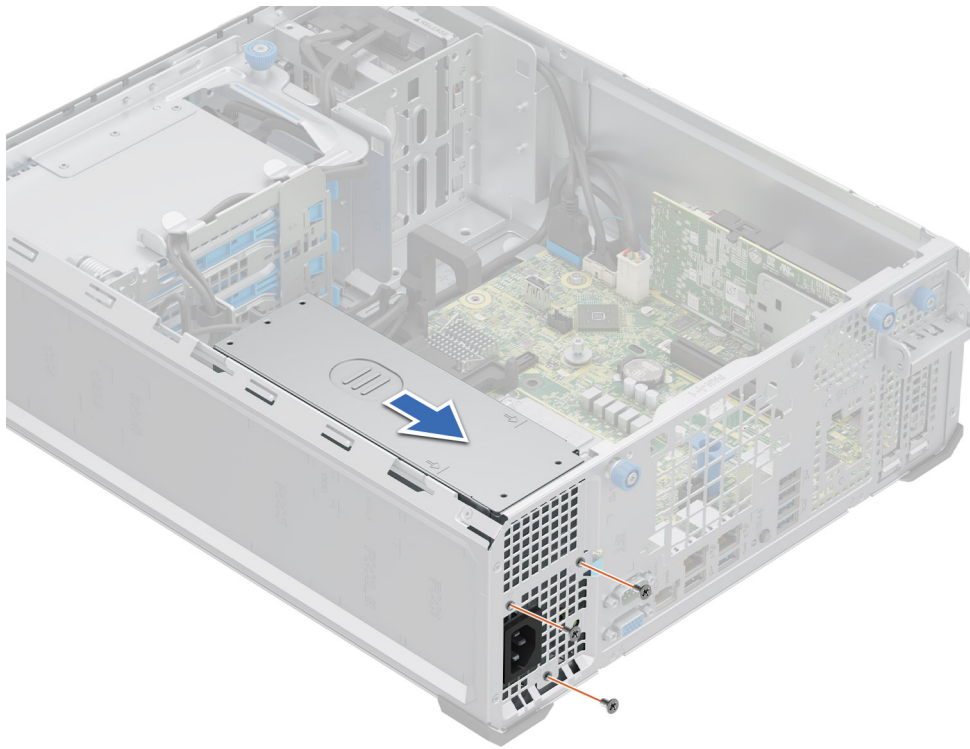

Figure 58. Installing the cabled PSU

#### Next steps

1. Connect all the power cables from the PSU to the system board.
2. Route the power cables properly and secure them with cable clips.
3. Follow the procedure listed in [After working inside your system](#).

## System battery

This is a service technician replaceable part only.

## Replacing the system battery

#### Prerequisites

**⚠ WARNING:** There is a danger of a new battery exploding if it is incorrectly installed. Replace the battery only with the same or equivalent type that is recommended by the manufacturer. Discard used batteries according to the manufacturer's instructions. See the Safety instructions that came with your system for more information.

1. Follow the safety guidelines listed in the [Safety instructions](#).
2. Follow the procedure listed in the [Before working inside your system](#).
3. If applicable, disconnect the power or data cables from the expansion cards.
4. [Remove the expansion cards](#).

#### Steps

1. To remove the battery:
  - a. Press and hold the battery socket retention latch, for the battery to pop out.

**i NOTE:** If the battery does not pop out, then lift it out of the socket.

**CAUTION:** To avoid damage to the battery connector, you must firmly support the connector while installing or removing a battery.

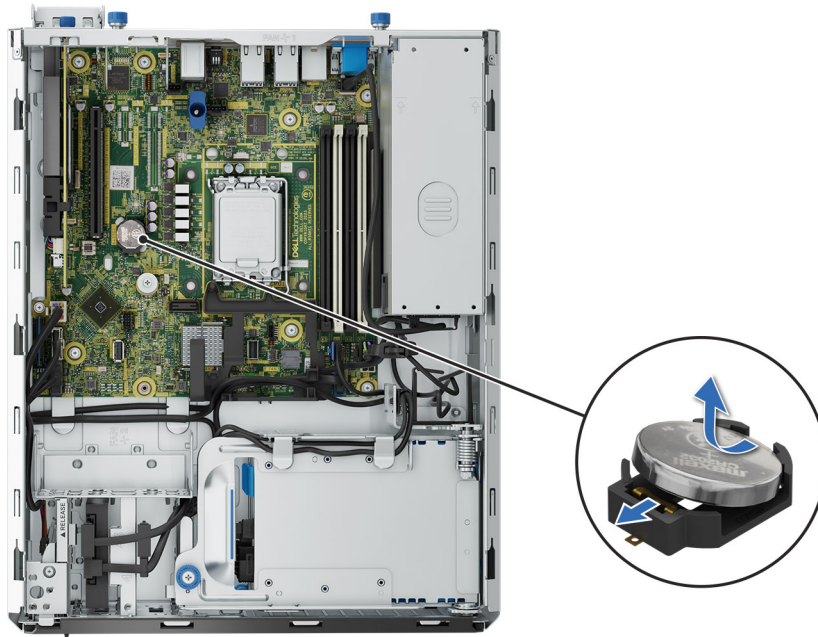

**Figure 59. Removing the system battery**

2. To install a new system battery:
  - a. Hold the battery with the positive side facing up and slide it under the securing tabs.
  - b. Press the battery into the connector until it snaps into place.

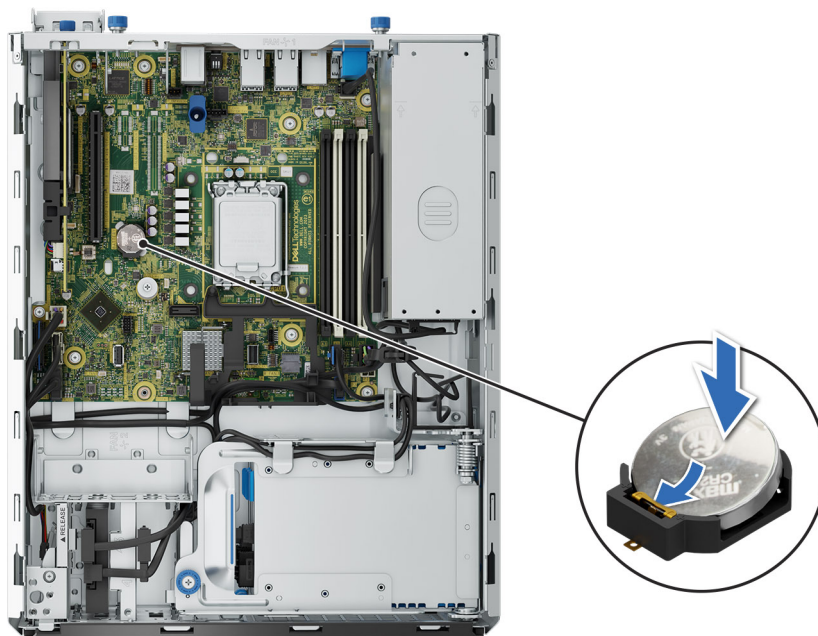

**Figure 60. Installing the system battery**

## Next steps

1. [Install the expansion card risers.](#)
2. If applicable, connect the cables to one or more expansion cards.
3. Follow the procedure listed in [After working inside your system.](#)
4. Confirm that the battery is operating properly, by performing the following steps:
  - a. Enter the System Setup, while booting, by pressing F2.
  - b. Enter the correct time and date in the System Setup **Time** and **Date** fields.
  - c. **Exit** the System Setup.
  - d. To test the newly installed battery, check the time and date at least an hour after installing the battery.
  - e. Enter the System Setup and if the time and date are still incorrect, see [Getting help](#) section.

# System board

This is a service technician replaceable part only.

## Removing the system board

### Prerequisites

 **CAUTION:** If you are using the Trusted Platform Module (TPM) with an encryption key, you may be prompted to create a recovery key during program or System Setup. Be sure to create and safely store this recovery key. If you replace this system board, you must supply the recovery key when you restart your system or program before you can access the encrypted data on your drives.

1. Follow the safety guidelines listed in the [Safety instructions.](#)
2. Follow the procedure listed in the [Before working inside your system.](#)
3. Remove the following components:
  - a. [Air shroud](#)
  - b. [3.5-inch HDD cage](#)
  - c. [Cooling fans](#)
  - d. [Memory modules](#)
  - e. [Expansion cards](#)
  - f. [Processor and heat sink module](#)
  - g. [Trusted Platform Module](#)
  - h. Disconnect all the cables from the system board and make note of all the cable connections.

 **CAUTION:** Take care not to damage the system identification button while removing the system board from the system.

 **CAUTION:** Do not lift the system board by holding a memory module, processor, or other components.

### Steps

1. Using a Phillips 2 screwdriver, remove the screws that secure the system board to the chassis. Remove the other screws first before removing the two step studs (A and B).

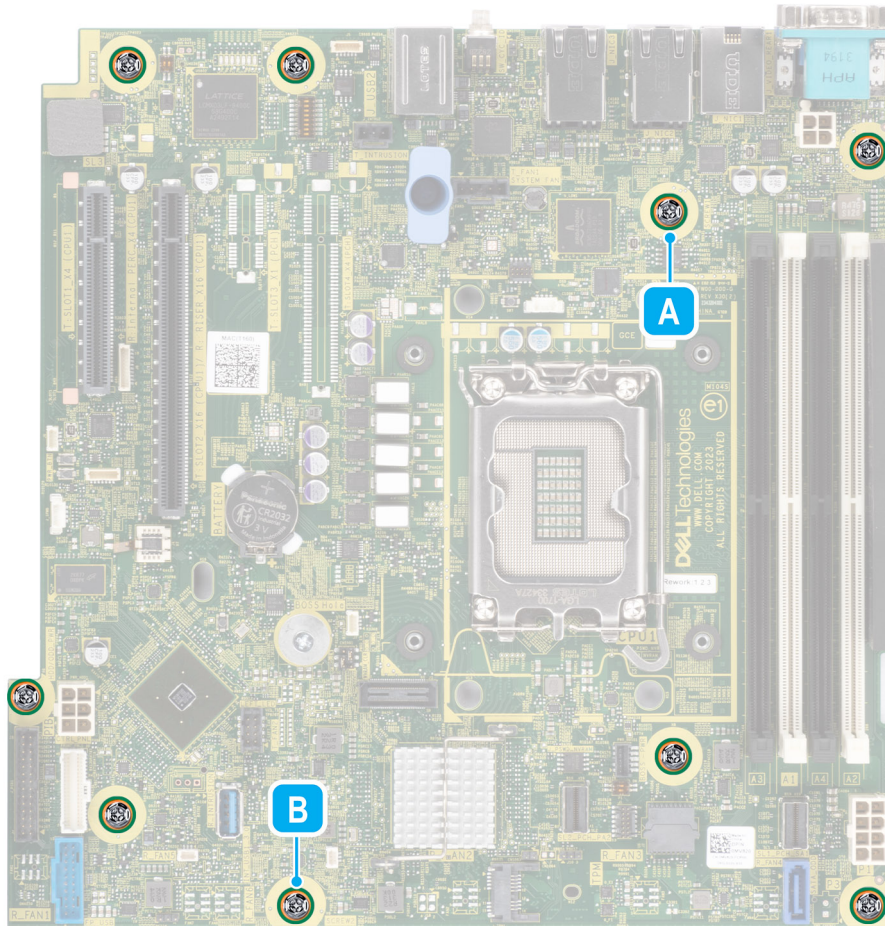

**Figure 61. System board screw location**

2. Using the system board holder and plunger, slide the system board towards the front of the system.
3. At a tilted angle, lift the system board out of the chassis.

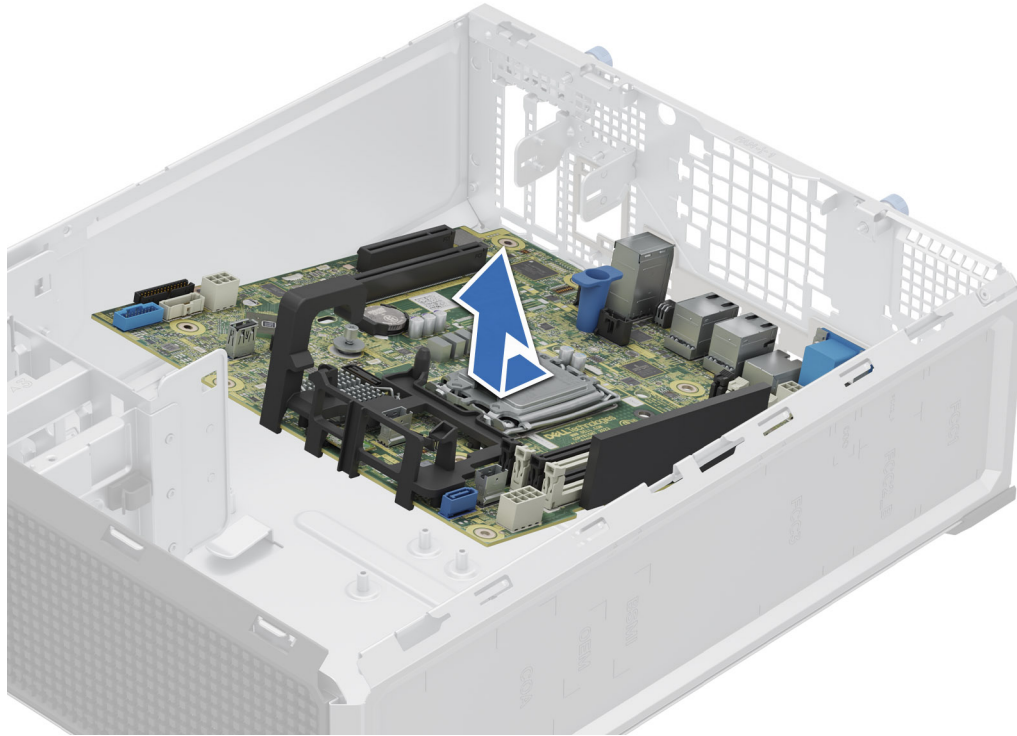

Figure 62. Removing the system board

### Next steps

1. [Replace the system board.](#)

## Installing the system board

### Prerequisites

**Note:** Before replacing the system board, replace the old iDRAC MAC address label on the Express Service Tag with the iDRAC MAC address label of the replacement system board.

1. Follow the safety guidelines listed in the [Safety instructions](#).
2. Follow the procedure listed in [Before working inside your system](#).
3. If you are replacing the system board, remove all the components that are listed in the removing the system board section.

### Steps

1. Unpack the new system board assembly.

**CAUTION:** Do not lift the system board by holding a memory module, processor, or other components.

**CAUTION:** Take care not to damage the system identification button while placing the system board into the chassis.

2. Holding the system board holder and plunger, lower the system board at a tilted angle into the system.
3. Slide the system board towards the rear of the chassis until the connectors are firmly seated in the slots.

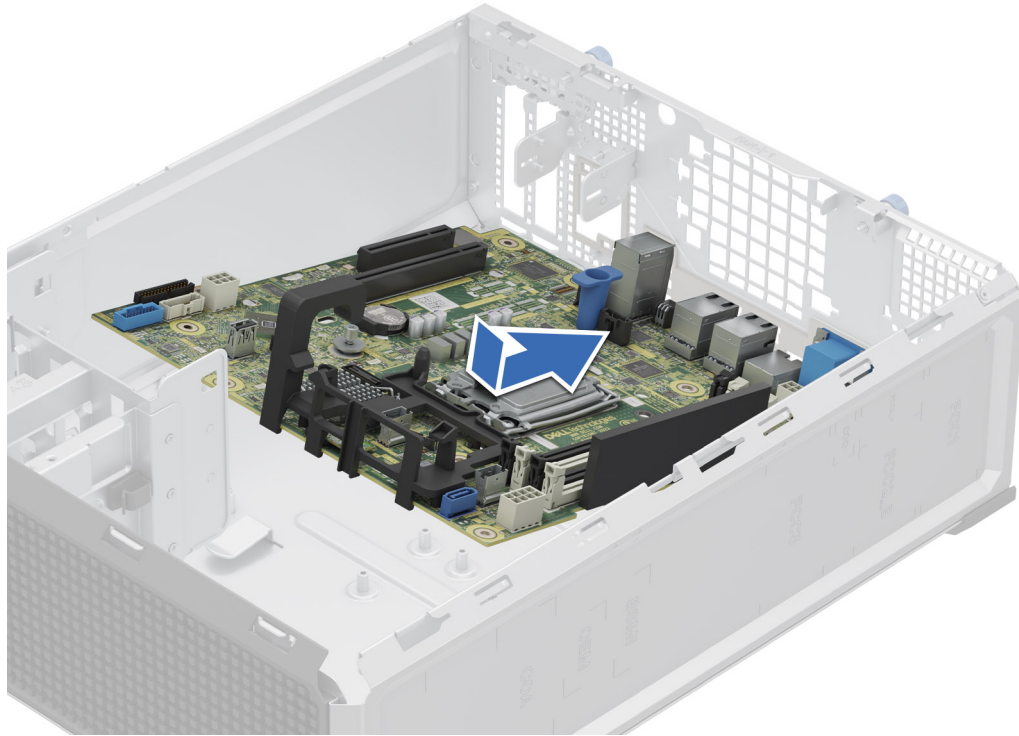

**Figure 63. Installing the system board**

4. Using the Phillips 2 screwdriver secure the system board to the chassis with screws. Tighten the two step studs (A and B) first and then fix the other screws.

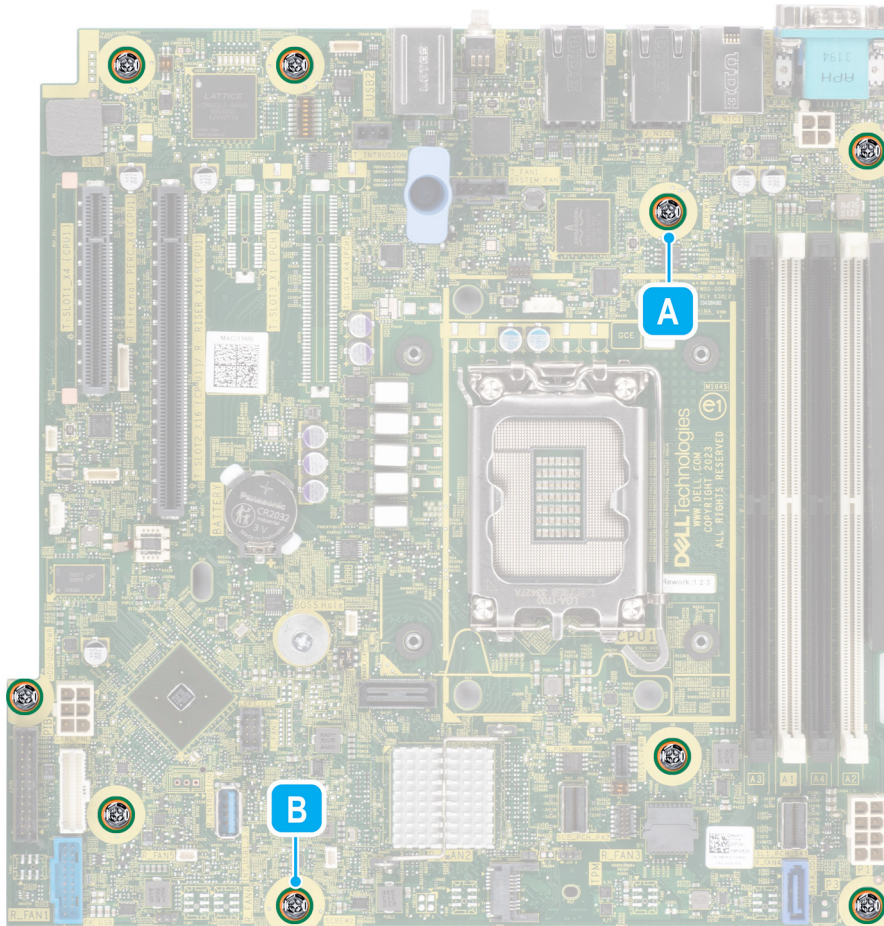

**Figure 64. System board screw location**

### Next steps

1. Replace the following components:
  - a. [Trusted Platform Module \(TPM\)](#)

**i** **NOTE:** The TPM Module must be replaced only while installing new system board.

- b. [Processor and heat sink module](#)
- c. [Memory modules](#)
- d. [Expansion cards](#)
- e. [Cooling fans](#)
- f. [Air shroud](#)

2. Reconnect all cables to the system board.

**i** **NOTE:** Ensure that the cables inside the system are routed along the chassis wall and secured using the cable securing bracket.

3. Ensure that you perform the following steps:
  - a. Use the Easy Restore feature to restore the Service Tag. See the [Restoring the system by using the Easy Restore feature](#) section.
  - b. If the service tag is not backed up in the backup flash device, enter the system service tag manually. See the [Manually update the Service Tag](#) by using System Setup section.
  - c. Update the BIOS and iDRAC versions.
  - d. Re-enable the Trusted Platform Module (TPM). See the [Upgrading the Trusted Platform Module](#) section.
4. Follow the procedure listed in [After working inside your system](#).

## Restoring the system using Easy Restore

The Easy Restore feature enables you to restore your service tag, license, UEFI configuration, and the system configuration data after replacing the system board. All data is backed up in a backup flash device automatically. If BIOS detects a new system board, and the service tag in the backup flash device, BIOS prompts the user to restore the backup information.

### About this task

Below is a list of options/steps available:

#### Steps

1. Restore the service tag, license, and diagnostics information, press **Y**
2. Navigate to the Lifecycle Controller based restore options, press **N**
3. Restore data from a previously created **Hardware Server Profile**, press **F10**  
**i** **NOTE:** When the restore process is complete, BIOS prompts to restore the system configuration data.
4. Restore data from a previously created **Hardware Server Profile**, press **F10**
5. To restore the system configuration data, press **Y**
6. To use the default configuration settings, press **N**  
**i** **NOTE:** After the restore process is complete, system reboots.

## Manually update the Service Tag

After replacing a system board, if Easy Restore fails, follow this process to manually enter the Service Tag, using **System Setup**.

### About this task

If you know the system service tag, use the **System Setup** menu to enter the service tag.

#### Steps

1. Power on the system.
2. To enter the **System Setup**, press **F2**.
3. Click **Service Tag Settings**.
4. Enter the service tag.  
**i** **NOTE:** You can enter the service tag only when the **Service Tag** field is empty. Ensure that you enter the correct service tag. Once the service tag is entered, it cannot be updated or changed. Incorrectly entered service tag will lead to system board replacement.
5. Click **OK**.

## Trusted Platform Module

This is a service technician replaceable part only.

## Upgrading the Trusted Platform Module

### Removing the TPM

#### Prerequisites

1. Follow the safety guidelines listed in the [Safety instructions](#).



2. Follow the procedure listed in [Before working inside your system](#).

**NOTE:**

- Ensure that the operating system is compatible with the TPM version you are installing.
- Ensure that you download and install the latest BIOS firmware on your system.
- Ensure that the BIOS is configured to enable UEFI boot mode.

**CAUTION:** The TPM plug-in module is cryptographically bound to that particular system board after it is installed. When the system is powered on, any attempt to remove an installed TPM plug-in module breaks the cryptographic binding, and the removed TPM cannot be installed on another system board. Ensure any keys that you have stored on the TPM have been securely transferred.

### Steps

1. Locate the TPM connector on the system board.
2. Press to hold the module down and remove the screw using the security Torx 8-bit shipped with the TPM module.
3. Slide the TPM module out from its connector.
4. Push the plastic rivet away from the TPM connector and rotate it 90° counterclockwise to release it from the system board.
5. Pull the plastic rivet out of its slot on the system board.

## Installing the TPM

### Prerequisites

1. Follow the safety guidelines listed in the [Safety instructions](#).
2. Follow the procedure listed in [Before working inside your system](#).

### Steps

1. To install the TPM, align the edge connectors on the TPM with the slot on the TPM connector.
2. Insert the TPM into the TPM connector such that the plastic rivet aligns with the slot on the system board.
3. Press the plastic rivet until the rivet snaps into place.
4. Replace the screw that secures the TPM to the system board.

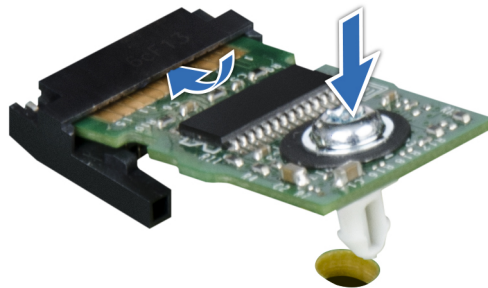

Figure 65. Installing the TPM

## Initializing TPM for users

### Steps

1. Initialize the TPM.
2. The **TPM Status** changes to **Enabled, Activated**.

## Initializing the TPM 2.0 for users

### Steps

1. While booting your system, press F2 to enter System Setup.
2. On the **System Setup Main Menu** screen, click **System BIOS** > **System Security Settings**.
3. From the **TPM Security** option, select **On**.
4. Save the settings.
5. Restart your system.

## Control panel

This is a service technician replaceable part only.

## Removing the control panel assembly

### Prerequisites

1. Follow the safety guidelines listed in [Safety instructions](#).
2. Follow the procedure listed in [Before working inside your system](#).
3. Disconnect all peripherals that are connected to the control panel.
4. [Remove the air shroud](#).
5. Disconnect the control panel cable and the control panel USB cable from the connector system board.

 **NOTE:** Remove the control panel cables from the cable tie.

### Steps

1. Release the FIO module by pulling the release latch.
2. Using a Phillips 2 screwdriver, remove the screws that secure the control panel to the control panel cage.
3. Slide the control panel out of the control panel cage.



**Figure 66. Removing the control panel cage**

4. To remove control panel assembly:
  - a. Using a Phillips 2 screwdriver, remove the screws that secure the control panel assembly to the cage.
  - b. Slide out and remove the control panel assembly from the cage.

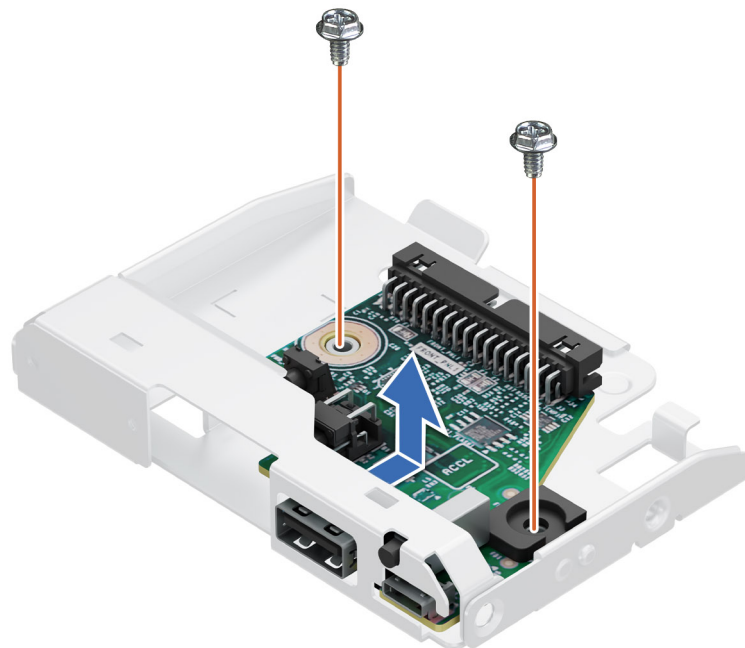

**Figure 67. Removing the control panel assembly**

### Next steps

1. [Replace the control panel assembly.](#)

## Installing the control panel assembly

### Prerequisites

1. Follow the safety guidelines listed in [Safety instructions](#).
2. Follow the procedure listed in [Before working inside your system](#).
3. [Remove the air shroud](#).

### Steps

1. To install control panel assembly:
  - a. Align and slide the control panel assembly into the control panel cage.
  - b. Using a Phillips 2 screwdriver, tighten the screws that secure the control panel assembly to the cage.

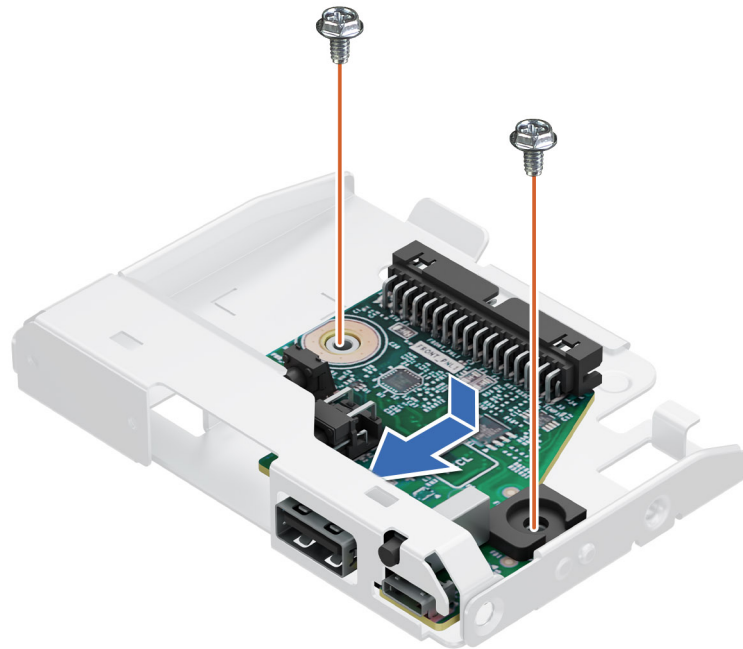

**Figure 68. Installing the control panel assembly**

2. To install control panel cage:
  - a. Connect the cable to the control panel assembly.
  - b. Slide the control panel cage into the system until it clicks into its place.
  - c. Fix the screw that secures the control panel to the control panel cage.



**Figure 69. Installing the control panel cage**

#### **Next steps**

1. Connect the control panel cable and the control panel USB cable to the system board.

**i** **NOTE:** Secure the control panel cables with the cable tie to prevent it from being pinched or crimped.

2. Follow the procedure listed in [After working inside your system.](#)

# Upgrade Kits

The table lists the available After Point Of Sale [APOS] kits.

**Table 67. Upgrade kits**

Kits	Related links to service instructions
Memory modules	See <a href="#">Installing the memory module</a>
SSDs	See <a href="#">Installing the SSDs</a>
Processors	See <a href="#">Installing the processor</a>
Heat sink	See <a href="#">Installing the heat sink</a>
Storage controller cards	See <a href="#">Installing the expansion card into the expansion card slots</a>
HBA	
Network cards	
Power supplies	See <a href="#">Installing the power supply units</a>
Cables	See <a href="#">Cable routing</a>
Power cords	N/A
BOSS N1	See <a href="#">Installing an BOSS N1 module</a>

## Topics:

- [BOSS-N1 module kit](#)

## BOSS-N1 module kit

The BOSS-N1 module supports up to two M.2 NVMe SSDs.

Before you begin the installation or removal process, follow the [safety guidelines](#) and [before working inside the system](#) instructions.

**Table 68. BOSS-N1 module kit components**

Components in kit	T160 (quantity)
BOSS-N1 controller card module	1
BOSS-N1 card carrier	1 or 2*
M.2 NVMe SSD	1 or 2*
M.2 NVMe SSD capacity label	1 or 2†
BOSS-N1 card carrier blank	1
M3 x 0.5 x 4.5 mm screws	1
BOSS-N1 signal cable for mother board (230 mm)	1
BOSS-N1 power cable for mother board (175 mm)	1
High Performance (HPR)/PCIe fan	1

 **NOTE:** \*The quantity depends on the purchase order.

 **NOTE:** †The quantity depends on the BOSS-N1 card carrier.

To remove the BOSS blank :

1. See [Removing the BOSS blank](#).

To install the BOSS-N1 module:

1. To install the BOSS-N1 module, see [Installing the BOSS-N1 card carrier](#).
2. [Install the PCIE cooling fan for BOSS-N1 module](#).

 **NOTE:** Refer to [cable routing](#) section for BOSS N1 cable connections.

 **NOTE:** Installing the BOSS-N1 card carrier does not require the system to be powered off. System shutdown is only required when installing the BOSS-N1 controller card module.

# Jumpers and connectors

This topic provides some basic and specific information about jumpers and switches. It also describes the connectors on the various boards in the system. Jumpers on the system board help to disable the system and reset the passwords. To install components and cables correctly, you must know the connectors on the system board.

## Topics:

- [System board layout](#)
- [System board jumper settings](#)
- [Disabling a forgotten password](#)

## System board layout

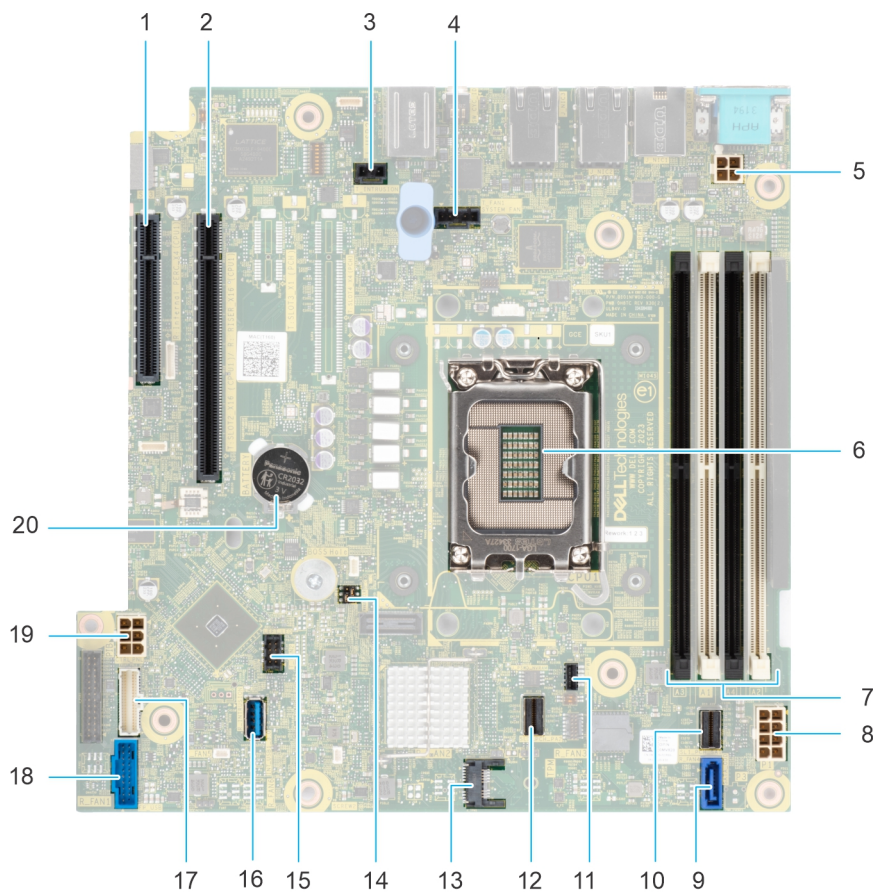

Figure 70. System board layout

Table 69. System board jumpers and connectors

Item	Connector	Description
1.	PCIe Slot 1 X4 (CPU)	PCIe card connector 1
2.	PCIe Slot 2 X16 (CPU)	PCIe card connector 2
3.	T_INTRUSION	Intrusion Switch Connector







**Table 69. System board jumpers and connectors (continued)**

Item	Connector	Description
4.	SYSTEM FAN	System cooling fan connector
5.	PWR_CPU 1	CPU power connector P2
6.	CPU	Processor socket
7.	A3, A1, A4, A2	Memory module sockets
8.	PWR_SYSTEM 1	System power connector P1
9.	SATA_ODD	Disk drive connector
10.	SL1 SATA X4	SATA connector
11.	BOSS_PWR	BOSS power connector
12.	SL2_PCH_PA2	BOSS signal connector
13.	TPM	Trusted platform module connector
14.	PWRD_EN and NVRAM_CLR	Jumper
15.	T_FAN 2	Fan Connector
16.	INT_USB1_3.0	Internal USB 3.0
17.	CTRL_PNL	Control panel
18.	FP_USB	Front panel USB connector
19.	HDD/ODD_POWER	Hard drive power connector
20.	BATTERY	CMOS Battery connector

## System board jumper settings

For information about resetting the password jumper to disable a password, see the [Disabling a forgotten password](#) section.

**Table 70. System board jumper settings**

Jumper	Setting	Description
PWRD_EN	 2 4 6 (default)	The BIOS password feature is enabled.
	 2 4 6	The BIOS password feature is disabled. The BIOS password is now disabled and you are not allowed to set a new password.
NVRAM_CLR	 1 3 5 (default)	The BIOS configuration settings are retained at system boot.
	 1 3 5	The BIOS configuration settings are cleared at system boot.

**CAUTION:** You should be cautious when changing the BIOS settings. The BIOS interface is designed for advanced users. Any changes in the setting might prevent your system from starting correctly and may even result in data loss.



# Disabling a forgotten password

The software security features of the system include a system password and a setup password. The password jumper enables or disables password features and clears any password(s) currently in use.

## Prerequisites

 **CAUTION:** Many repairs may only be done by a certified service technician. You should only perform troubleshooting and simple repairs as authorized in your product documentation, or as directed by the online or telephone service and support team. Damage due to servicing that is not authorized by Dell is not covered by your warranty. Read and follow the safety instructions that are shipped with your product.

## Steps

1. Power off the system and all attached peripherals. Disconnect the system from the electrical outlet, and disconnect the peripherals.
2. Remove the system cover.
3. Move the jumper on the system board from pins 2 and 4 to pins 4 and 6.
4. Replace the system cover.
  -  **NOTE:** The existing passwords are not disabled (erased) until the system boots with the jumper on pins 4 and 6. However, before you assign a new system and/or setup password, you must move the jumper back to pins 2 and 4.
  -  **NOTE:** If you assign a new system and/or setup password with the jumper on pins 4 and 6, the system disables the new password(s) the next time it boots.
5. Reconnect the peripherals and connect the system to the electrical outlet, and then power on the system.
6. Power off the system.
7. Remove the system cover.
8. Move the jumper on the system board from pins 4 and 6 to pins 2 and 4.
9. Replace the system cover.
10. Reconnect the peripherals and connect the system to the electrical outlet, and then power on the system.
11. Assign a new system and/or setup password.

# System diagnostics and indicator codes

The diagnostic indicators on the system front panel display system status during system startup.

## Topics:

- [System ID indicator](#)
- [iDRAC Direct LED indicator codes](#)
- [NIC indicator codes](#)
- [Non-redundant cabled power supply unit indicator codes](#)
- [Using system diagnostics](#)

## System ID indicator

The system ID LED is located at the front and rear of the system. All system ID are synchronized i.e., if rear system ID is triggered, front system ID is also activated.



Figure 71. System ID indicator

Table 71. System ID indicator codes

System ID indicator code	Condition
Blinking blue	Press the button to identify a system by turning on the system ID button. You can also use the system ID button to reset iDRAC and to access the BIOS using the step-through mode. When pressed, the system ID LED in the front or back panel blinks until either the front or rear button is pressed again. Press the button to toggle between on or off mode.

## iDRAC Direct LED indicator codes

The iDRAC Direct LED indicator lights up to indicate that the port is connected and is being used as a part of the iDRAC subsystem.

You can configure iDRAC Direct by using a USB to micro USB (type AB) cable, which you can connect to your laptop or tablet. Cable length should not exceed 3 feet (0.91 meters). Performance could be affected by cable quality. The following table describes iDRAC Direct activity when the iDRAC Direct port is active:

**Table 72. iDRAC Direct LED indicator codes**

iDRAC Direct LED indicator code	Condition
Solid green for two seconds	Indicates that the laptop or tablet is connected.
Blinking green (on for two seconds and off for two seconds)	Indicates that the laptop or tablet connected is recognized.
LED Indicator off	Indicates that the laptop or tablet is unplugged.

## NIC indicator codes

Each NIC on the back of the system has indicators that provide information about the activity and link status. The activity LED indicator indicates if data is flowing through the NIC, and the link LED indicator indicates the speed of the connected network.

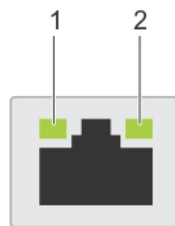

**Figure 72. NIC indicator codes**

1. Link LED indicator
2. Activity LED indicator

**Table 73. NIC indicator codes**

NIC indicator codes	Condition
Link and activity indicators are off.	Indicates that the NIC is not connected to the network.
Link indicator is green, and activity indicator is blinking green.	Indicates that the NIC is connected to a valid network at its maximum port speed, and data is being sent or received.
Link indicator is amber, and activity indicator is blinking green.	Indicates that the NIC is connected to a valid network at less than its maximum port speed, and data is being sent or received.
Link indicator is green, and activity indicator is off.	Indicates that the NIC is connected to a valid network at its maximum port speed, and data is not being sent or received.
Link indicator is amber, and activity indicator is off.	Indicates that the NIC is connected to a valid network at less than its maximum port speed, and data is not being sent or received.
Link indicator is blinking green, and activity is off.	Indicates that the NIC identity is enabled through the NIC configuration utility.

# Non-redundant cabled power supply unit indicator codes

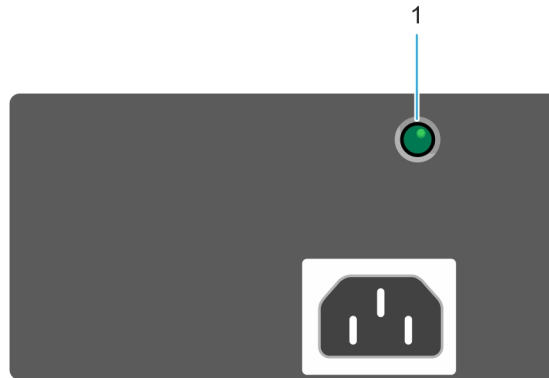

Figure 73. Non-redundant cabled AC PSU status indicator

1. AC PSU status indicator

Table 74. Non-redundant AC PSU status indicator

Power Indicator Pattern	Condition
Not lit	Power is not connected, or the PSU is faulty.
Green	A valid power source is connected to the PSU, and the PSU is operational.

## Using system diagnostics

If you experience an issue with the system, run the system diagnostics before contacting Dell for technical assistance. The purpose of running system diagnostics is to test the system hardware without using additional equipment or risking data loss. If you are unable to fix the issue yourself, service and support personnel can use the diagnostics results to help you solve the issue.

## Dell Embedded System Diagnostics

**NOTE:** The Dell Embedded System Diagnostics is also known as Enhanced Pre-boot System Assessment (ePSA) diagnostics.

The Embedded System Diagnostics provide a set of options for particular device groups or devices allowing you to:

- Run tests automatically or in an interactive mode
- Repeat tests
- Display or save test results
- Run thorough tests to introduce additional test options to provide extra information about the failed device(s)
- View status messages that inform you if tests are completed successfully
- View error messages that inform you of issues encountered during testing

## Running the Embedded System Diagnostics from Boot Manager

Run the Embedded System Diagnostics (ePSA) if your system does not boot.

### Steps

1. When the system is booting, press F11.
2. Use the up arrow and down arrow keys to select **System Utilities > Launch Diagnostics**.

- Alternatively, when the system is booting, press F10, select **Hardware Diagnostics > Run Hardware Diagnostics**. The **ePSA Pre-boot System Assessment** window is displayed, listing all devices detected in the system. The diagnostics starts executing the tests on all the detected devices.

## Running the Embedded System Diagnostics from the Dell Lifecycle Controller

### Steps

- When the system is booting, press F10.
- Select **Hardware Diagnostics → Run Hardware Diagnostics**. The **ePSA Pre-boot System Assessment** window is displayed, listing all devices detected in the system. The diagnostics start executing the tests on all the detected devices.

## System diagnostic controls

**Table 75. System diagnostic controls**

Menu	Description
<b>Configuration</b>	Displays the configuration and status information of all detected devices.
<b>Results</b>	Displays the results of all tests that are run.
<b>System health</b>	Provides the current overview of the system performance.
<b>Event log</b>	Displays a time-stamped log of the results of all tests run on the system. This is displayed if at least one event description is recorded.

# Getting help

## Topics:

- [Recycling or End-of-Life service information](#)
- [Contacting Dell Technologies](#)
- [Accessing system information by using QR code](#)
- [Receiving automated support with Secure Connect Gateway \(SCG\)](#)

## Recycling or End-of-Life service information

Take back and recycling services are offered for this product in certain countries. If you want to dispose of system components, visit [How to Recycle](#) and select the relevant country.

## Contacting Dell Technologies

Dell provides online and telephone based support and service options. If you do not have an active internet connection, you can find Dell contact information on your purchase invoice, packing slip, bill or Dell product catalog. The availability of services varies depending on the country and product, and some services may not be available in your area. To contact Dell for sales, technical assistance, or customer service issues follow these steps:

### Steps

1. Go to [Dell Support](#).
2. Select your country from the drop-down menu on the lower right corner of the page.
3. For customized support:
  - a. Enter the system Service Tag in the **Enter a Service Tag, Serial Number, Service Request, Model, or Keyword** field.
  - b. Click **Search**.  
The support page that lists the various support categories is displayed.
4. For general support:
  - a. Select your product category.
  - b. Select your product segment.
  - c. Select your product.  
The support page that lists the various support categories is displayed.
5. For contact details of Dell Global Technical Support:
  - a. Click [Contact Technical Support](#).
  - b. The **Contact Technical Support** page is displayed with details to call, chat, or e-mail the Dell Global Technical Support team.

## Accessing system information by using QR code

There is also another QR code for accessing product information on the back of the system cover.

### Prerequisites

Ensure that your smart phone or tablet has a QR code scanner installed.

The QR code includes the following information about your system:

- How-to videos

- Reference materials, including the Installation and Service Manual, and mechanical overview
- The system service tag to quickly access the specific hardware configuration and warranty information
- A direct link to Dell to contact technical support and sales teams

### Steps

1. Go to [PowerEdge Manuals](#), and navigate to your specific product or
2. Use your smart phone or tablet to scan the model-specific QR code on your system. There is also another QR code for accessing product information in the booklet, located on the air shroud.

## QR code for PowerEdge T160 system resources



Figure 74. QR code for PowerEdge T160 system

**NOTE:** The QR code is located underneath the SIL booklet for T160.

## Receiving automated support with Secure Connect Gateway (SCG)

Dell Secure Connect Gateway (SCG) is an optional Dell Services offering that automates technical support for your Dell server, storage, and networking devices. By installing and setting up a Secure Connect Gateway (SCG) application in your IT environment, you can receive the following benefits:

- Automated issue detection — Secure Connect Gateway (SCG) monitors your Dell devices and automatically detects hardware issues, both proactively and predictively.
- Automated case creation — When an issue is detected, Secure Connect Gateway (SCG) automatically opens a support case with Dell Technical Support.
- Automated diagnostic collection — Secure Connect Gateway (SCG) automatically collects system state information from your devices and uploads it securely to Dell. This information is used by Dell Technical Support to troubleshoot the issue.
- Proactive contact — A Dell Technical Support agent contacts you about the support case and helps you resolve the issue.

The available benefits vary depending on the Dell Service entitlement purchased for your device. For more information about Secure Connect Gateway (SCG), go to [secureconnectgateway](#).



## Documentation resources

This section provides information about the documentation resources for your system.

To view the document that is listed in the documentation resources table:

- From the Dell support site:
  1. Click the documentation link that is provided in the Location column in the table.
  2. Click the required product or product version.

 **NOTE:** To locate the model number, see the front of your system.

3. On the Product Support page, click **Documentation**.
- Using search engines:
    - Type the name and version of the document in the search box.

**Table 76. Additional documentation resources for your system**

Task	Document	Location
Setting up your system	For information about setting up your system, see the <i>Getting Started Guide</i> document that is shipped with your system.	<a href="#">PowerEdge Manuals</a>
Configuring your system	For information about the iDRAC features, configuring and logging in to iDRAC, and managing your system remotely, see the Integrated Dell Remote Access Controller User's Guide.	<a href="#">PowerEdge Manuals</a>
	For information about understanding Remote Access Controller Admin (RACADM) subcommands and supported RACADM interfaces, see the RACADM CLI Guide for iDRAC.	
	For information about Redfish and its protocol, supported schema, and Redfish Eventing implemented in iDRAC, see the Redfish API Guide.	
	For information about iDRAC property database group and object descriptions, see the Attribute Registry Guide.	<a href="#">iDRAC Manuals</a>
	For information about Intel QuickAssist Technology, see the Integrated Dell Remote Access Controller User's Guide.	
	For information about earlier versions of, the iDRAC documents.	
	To identify the version of iDRAC available on your system, on the iDRAC web interface, click <b>? &gt; About</b> .	
	For information about installing the operating system, see the operating system documentation.	<a href="#">Operating System Manuals</a>

**Table 76. Additional documentation resources for your system (continued)**

<b>Task</b>	<b>Document</b>	<b>Location</b>
	For information about updating drivers and firmware, see the Methods to download firmware and drivers section in this document.	<a href="#">Drivers</a>
Managing your system	For information about systems management software offered by Dell, see the Dell OpenManage Systems Management Overview Guide.	<a href="#">PowerEdge Manuals</a>
	For information about setting up, using, and troubleshooting OpenManage, see the Dell OpenManage Server Administrator User's Guide.	<a href="#">OpenManage Manuals</a>
	For information about installing and using Dell Secure Connect Gateway, see the Dell Secure Connect Gateway Enterprise User's Guide.	<a href="#">serviceability tools</a>
	For information about partner programs enterprise systems management, see the OpenManage Connections Enterprise Systems Management documents.	<a href="#">OpenManage Manuals</a>
Working with the Dell PowerEdge RAID controllers (if applicable)	For information about understanding the features of the Dell PowerEdge RAID controllers (PERC), Software RAID controllers, or BOSS card and deploying the cards, see the Storage controller documentation.	<a href="#">Storage Controller Manuals</a>
Understanding event and error messages	For information about the event and error messages generated by the system firmware and agents that monitor system components, see the EEMI guide.	<a href="#">EEMI Guide</a>
Troubleshooting your system	For information about identifying and troubleshooting the PowerEdge server issues, see the Server Troubleshooting Guide.	<a href="#">PowerEdge Manuals</a>