

Dell PowerEdge R6615

Installation and Service Manual

Notes, cautions, and warnings

 **NOTE:** A NOTE indicates important information that helps you make better use of your product.

 **CAUTION:** A CAUTION indicates either potential damage to hardware or loss of data and tells you how to avoid the problem.

 **WARNING:** A WARNING indicates a potential for property damage, personal injury, or death.

| | |
|--|-----------|
| Chapter 1: About this document | 8 |
| Chapter 2: System overview | 9 |
| Front view of the system..... | 9 |
| Rear view of the system..... | 11 |
| Inside the system..... | 14 |
| Locating the Express Service Code and Service Tag..... | 18 |
| System information label..... | 18 |
| Rail sizing and rack compatibility matrix..... | 21 |
| Chapter 3: Technical specifications | 22 |
| Chassis dimensions | 22 |
| System weight..... | 23 |
| Processor specifications..... | 23 |
| PSU specifications..... | 23 |
| Supported operating systems..... | 24 |
| Cooling fan specifications..... | 24 |
| System battery specifications..... | 25 |
| Expansion card riser specifications..... | 25 |
| PCIe Riser Configuration..... | 26 |
| Memory specifications..... | 26 |
| Storage controller specifications..... | 27 |
| Drives..... | 27 |
| Ports and connectors specifications..... | 28 |
| USB ports specifications..... | 28 |
| NIC port specifications..... | 29 |
| Serial connector specifications..... | 29 |
| VGA ports specifications..... | 29 |
| Video specifications..... | 30 |
| Environmental specifications..... | 30 |
| Thermal air restrictions..... | 32 |
| Thermal air restrictions..... | 34 |
| Chapter 4: Initial system setup and configuration | 35 |
| Setting up the system..... | 35 |
| iDRAC configuration..... | 35 |
| Options to set up iDRAC IP address..... | 35 |
| Options to log in to iDRAC..... | 35 |
| Resources to install operating system..... | 36 |
| Options to download drivers and firmware | 36 |
| Options to download and install OS drivers | 36 |
| Downloading drivers and firmware..... | 37 |
| Chapter 5: Pre-operating system management applications | 38 |

| | |
|---|-----------|
| System Setup..... | 38 |
| System BIOS..... | 39 |
| iDRAC Settings utility..... | 55 |
| Device Settings..... | 55 |
| Dell Lifecycle Controller..... | 55 |
| Embedded system management..... | 55 |
| Boot Manager..... | 55 |
| PXE boot..... | 56 |
| Chapter 6: Minimum to POST and system management configuration validation..... | 57 |
| Minimum configuration to POST | 57 |
| Configuration validation..... | 57 |
| Error messages..... | 58 |
| Chapter 7: Installing and removing system components..... | 59 |
| Safety instructions..... | 59 |
| Before working inside your system..... | 60 |
| After working inside your system..... | 60 |
| Recommended tools..... | 60 |
| Optional front bezel..... | 61 |
| Removing the front bezel..... | 61 |
| Installing the front bezel..... | 62 |
| System cover..... | 63 |
| Removing the system cover..... | 63 |
| Installing the system cover..... | 64 |
| Drive backplane cover..... | 65 |
| Removing the drive backplane cover..... | 65 |
| Installing the drive backplane cover..... | 66 |
| Air shroud..... | 68 |
| Removing the air shroud..... | 68 |
| Installing the air shroud..... | 68 |
| Cooling fan..... | 69 |
| Removing a cooling fan..... | 69 |
| Installing a cooling fan..... | 70 |
| Drives..... | 71 |
| Removing a drive blank..... | 71 |
| Installing a drive blank..... | 72 |
| Removing a drive carrier..... | 72 |
| Installing the drive carrier..... | 73 |
| Removing the drive from the drive carrier..... | 74 |
| Installing the drive into the drive carrier..... | 75 |
| Rear drive module..... | 76 |
| Removing the rear drive module..... | 76 |
| Installing the rear drive module..... | 77 |
| Drive backplane..... | 78 |
| Drive backplane..... | 78 |
| Removing the drive backplane | 79 |
| Installing the drive backplane..... | 80 |
| Side wall brackets..... | 81 |

| | |
|---|-----|
| Side and center bracket perfect sealing..... | 81 |
| Removing the side wall bracket..... | 82 |
| Installing the side wall bracket..... | 83 |
| Cable routings..... | 84 |
| PERC module..... | 93 |
| Removing the front mounting front PERC module..... | 93 |
| Installing the front mounting front PERC module..... | 94 |
| Removing the rear mounting front PERC module..... | 95 |
| Installing the rear mounting front PERC module..... | 96 |
| System memory..... | 97 |
| System memory guidelines..... | 97 |
| General memory module installation guidelines..... | 99 |
| Removing a memory module..... | 100 |
| Installing a memory module..... | 100 |
| Processor and heat sink..... | 101 |
| Removing a heat sink..... | 101 |
| Removing the Direct Liquid Cooling module..... | 102 |
| Removing the AMD processor..... | 103 |
| Installing the AMD processor..... | 105 |
| Installing the heat sink..... | 107 |
| Installing the Direct Liquid Cooling module..... | 109 |
| Expansion cards and expansion card risers..... | 110 |
| Expansion card installation guidelines..... | 111 |
| Removing the expansion card risers..... | 127 |
| Installing the expansion card risers..... | 131 |
| Removing expansion card from the expansion card riser..... | 134 |
| Installing an expansion card into the expansion card riser..... | 136 |
| Optional serial COM port..... | 138 |
| Removing the serial COM port..... | 138 |
| Installing the serial COM port..... | 139 |
| VGA module..... | 140 |
| Removing the VGA module..... | 140 |
| Installing the VGA module..... | 141 |
| M.2 SSD module..... | 142 |
| Removing the M.2 NVMe SSD module..... | 142 |
| Installing the M.2 NVMe SSD module..... | 143 |
| Optional BOSS-N1 module..... | 144 |
| Removing the BOSS-N1 module blank..... | 144 |
| Installing the BOSS-N1 module blank..... | 144 |
| Removing the BOSS-N1 card carrier blank..... | 145 |
| Installing the BOSS-N1 card carrier blank..... | 146 |
| Removing the BOSS-N1 module..... | 147 |
| Installing the BOSS-N1 module..... | 150 |
| System battery | 152 |
| Replacing the system battery..... | 152 |
| Optional internal USB card..... | 154 |
| Removing the internal USB card..... | 154 |
| Installing the internal USB card..... | 155 |
| Intrusion switch module..... | 155 |
| Removing the intrusion switch..... | 155 |

| | |
|--|------------|
| Installing the intrusion switch..... | 156 |
| Optional OCP card..... | 157 |
| Removing the OCP card..... | 157 |
| Installing the OCP card..... | 158 |
| Control panel..... | 159 |
| Removing the right control panel..... | 159 |
| Installing the right control panel..... | 160 |
| Removing the left control panel..... | 161 |
| Installing the left control panel..... | 162 |
| Power supply unit..... | 163 |
| Hot spare feature..... | 163 |
| Removing a power supply unit blank..... | 164 |
| Installing a power supply unit blank..... | 164 |
| Removing a power supply unit..... | 165 |
| Installing a power supply unit..... | 165 |
| Trusted Platform Module..... | 166 |
| Upgrading the Trusted Platform Module..... | 166 |
| Initializing TPM for users..... | 167 |
| Initializing the TPM 1.2 for users..... | 167 |
| Initializing the TPM 2.0 for users..... | 168 |
| System board..... | 168 |
| Removing the system board..... | 168 |
| Installing the system board..... | 169 |
| Restoring Service Tag using Easy Restore..... | 171 |
| Manually update the Service Tag..... | 171 |
| LOM card and rear I/O board..... | 171 |
| Removing the LOM card and rear I/O board..... | 171 |
| Installing the LOM card and rear I/O board..... | 173 |
| Chapter 8: Upgrade Kits..... | 175 |
| BOSS-N1 module kit..... | 175 |
| Data Processing Unit (DPU) kit..... | 177 |
| Chapter 9: Serial COM port kit..... | 179 |
| Chapter 10: VGA port kit..... | 180 |
| Chapter 11: Internal USB card kit..... | 181 |
| Chapter 12: Jumpers and connectors..... | 182 |
| System board Connectors..... | 182 |
| System board jumper settings..... | 184 |
| Disabling a forgotten password..... | 184 |
| Chapter 13: System diagnostics and indicator codes..... | 185 |
| Power button LED..... | 185 |
| Status LED indicators..... | 185 |
| System health and system ID indicator codes..... | 187 |
| iDRAC Quick Sync 2 indicator codes..... | 188 |

| | |
|---|------------|
| iDRAC Direct LED indicator codes..... | 188 |
| LCD panel..... | 189 |
| Viewing Home screen..... | 190 |
| Setup menu..... | 190 |
| View menu..... | 190 |
| NIC indicator codes..... | 191 |
| Power supply unit indicator codes..... | 191 |
| Drive indicator codes..... | 193 |
| Using system diagnostics..... | 193 |
| Dell Embedded System Diagnostics..... | 194 |
| Chapter 14: Getting help..... | 195 |
| Recycling or End-of-Life service information..... | 195 |
| Contacting Dell Technologies..... | 195 |
| Accessing system information by using QRL..... | 196 |
| Chapter 15: Receiving automated support with SupportAssist | 197 |
| Chapter 16: Documentation resources..... | 198 |

About this document

This document provides an overview about the system, information about installing and replacing components, diagnostic tools, and guidelines to be followed while installing certain components.

System overview

The PowerEdge R6615 system is a 1U server that supports:

- One AMD EPYC 4th Generation 9004 series processor with up to 96 cores
- 12 DDR5 DIMM slots
- Optional Direct Liquid Cooling for required CPUs and/or configurations
- Two redundant AC or DC power supply units
- PCI Express® (PCIe) 5.0 enabled expansion slots
- Network interface technologies to cover Network Interface Card (NIC)
- Up to 10 x 2.5-inch SAS/SATA/NVMe drives or 8 x 2.5-inch NVMe SSD drives or 4 x 3.5-inch SATA/SAS drives or 2 x 2.5-inch (rear) SAS/SATA (HDD/SSD) drives.

NOTE: For more information about how to hot swap NVMe PCIe SSD U.2 device, see the *Dell Express Flash NVMe PCIe SSD User's Guide* at <https://www.dell.com/support> > **Browse all Products** > **Data Center Infrastructure** > **Storage Adapters & Controllers** > **Dell PowerEdge Express Flash NVMe PCIe SSD** > **Documentation** > **Manuals and Documents**.

NOTE: All instances of SAS, SATA drives are referred to as drives in this document, unless specified otherwise.

CAUTION: Do not install GPUs, network cards, or other PCIe devices on your system that are not validated and tested by Dell. Damage caused by unauthorized and invalidated hardware installation will null and void the system warranty.

Topics:

- [Front view of the system](#)
- [Rear view of the system](#)
- [Inside the system](#)
- [Locating the Express Service Code and Service Tag](#)
- [System information label](#)
- [Rail sizing and rack compatibility matrix](#)

Front view of the system

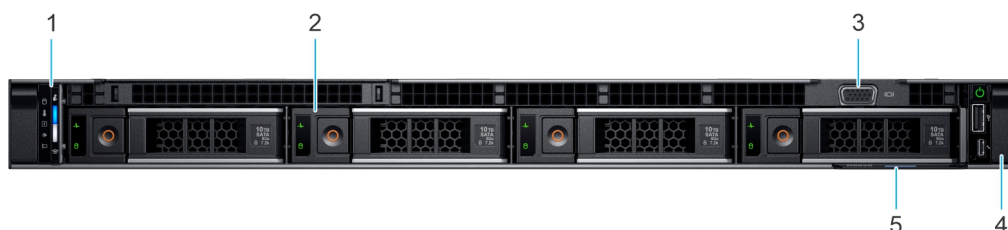

Figure 1. Front view of 4 x 3.5-inch drive system

Table 1. Features available on the 4 x 3.5-inch drive system

| Item | Ports, panels, and slots | Icon | Description |
|------|--------------------------|------|--|
| 1 | Left control panel | N/A | Contains the system health, system ID, and the status LED indicator. |
| 2 | Drive | N/A | Enables you to install drives that are supported on your system. |
| 3 | VGA | N/A | Enables you to connect a display device to the system. |

Table 1. Features available on the 4 x 3.5-inch drive system (continued)

| Item | Ports, panels, and slots | Icon | Description |
|------|--------------------------|------|---|
| 4 | Right control panel | N/A | Contains the power button with integrated power LED, 1 x VGA port, 1 x 2.0 USB port, iDRAC Direct (Micro-AB USB) port, and the iDRAC Direct status LED. |
| 5 | Information tag | N/A | The Express Service Tag is a slide-out label panel that contains system information such as Service Tag, NIC, MAC address, and so on. If you have opted for the secure default access to iDRAC, the Information tag will also contain the iDRAC secure default password. The Express Service Tag is a slide-out label panel that contains system information such as Service Tag, NIC, MAC address, and so on. If you have opted for the secure default access to iDRAC, the Information tag will also contain the iDRAC secure default password. |



Figure 2. Front view of 8 x 2.5-inch drive system

Table 2. Features available on the front of the 8 x 2.5-inch drive system

| Item | Ports, panels, and slots | Icon | Description |
|------|--------------------------|------|--|
| 1 | Left control panel | N/A | Contains the system health, system ID, and the status LED indicator. |
| 2 | Drive | N/A | Enables you to install drives that are supported on your system. |
| 3 | Right control panel | N/A | Contains the power button with integrated power LED, 1 x VGA port, 1 x 2.0 USB port, iDRAC Direct (Micro-AB USB) port, and the iDRAC Direct status LED. |
| 4 | VGA | N/A | Enables you to connect a display device to the system. |
| 5 | Information tag | N/A | The Express Service Tag is a slide-out label panel that contains system information such as Service Tag, NIC, MAC address, and so on. If you have opted for the secure default access to iDRAC, the Information tag will also contain the iDRAC secure default password. |



Figure 3. Front view of 10 x 2.5-inch drive system

Table 3. Features available on the front of 10 x 2.5-inch drive system

| Item | Ports, panels, and slots | Icon | Description |
|------|--------------------------|------|--|
| 1 | Left control panel | N/A | Contains the system health, system ID, and the status LED indicator. |
| 2 | Drive | N/A | Enables you to install drives that are supported on your system. |

Table 3. Features available on the front of 10 x 2.5-inch drive system (continued)

| Item | Ports, panels, and slots | Icon | Description |
|------|--------------------------|------|--|
| 3 | Right control panel | N/A | Contains the power button with integrated power LED, 1 x VGA port, 1 x 2.0 USB port, iDRAC Direct (Micro-AB USB) port, and the iDRAC Direct status LED. |
| 4 | VGA | N/A | Enables you to connect a display device to the system. |
| 5 | Information tag | N/A | The Express Service Tag is a slide-out label panel that contains system information such as Service Tag, NIC, MAC address, and so on. If you have opted for the secure default access to iDRAC, the Information tag will also contain the iDRAC secure default password. |

NOTE: For more information about ports, panels, and slots, see the Technical specifications section.

Rear view of the system

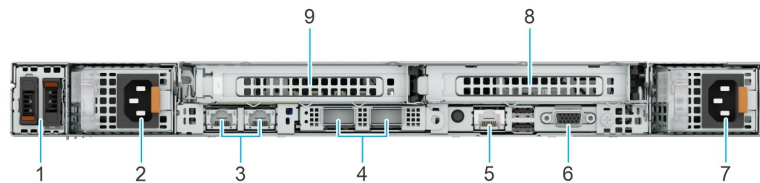





Figure 4. Rear view of system

Table 4. Rear view of the system

| Item | Ports, panels, or slots | Icon | Description |
|------|--------------------------------------|---|--|
| 1 | BOSS | N/A | Insert BOSS blank when BOSS module is not used. |
| 2 | Power supply unit (PSU1) |  | PSU1 is the primary PSU of the system. |
| 3 | NIC ports | N/A | The NIC ports that are integrated on the LOM card provide network connectivity which is connected to the system board. |
| 4 | OCP NIC card | N/A | The OCP NIC card supports OCP 3.0. The NIC ports are integrated on the OCP card which is connected to the system board. |
| 5 | Dedicated iDRAC9 Ethernet port |  | Enables you to remotely access iDRAC. For more information, see the Integrated <i>Dell Remote Access Controller User's Guide</i> at www.dell.com/poweredgemanuals . |
| 6 | VGA port | N/A | Enables you to connect a display device to the system. |
| 7 | Power supply unit (PSU2) |  | PSU2 is the secondary PSU of the system. |
| 8 | PCIe expansion card riser 4 (slot 2) | N/A | The expansion card riser enables you to connect PCI Express expansion cards. For more information, see the Expansion card installation guidelines section. |
| 9 | PCIe expansion card riser 1 (slot 1) | N/A | The expansion card riser enables you to connect PCI Express expansion cards. For more information, see the Expansion card installation guidelines section. |

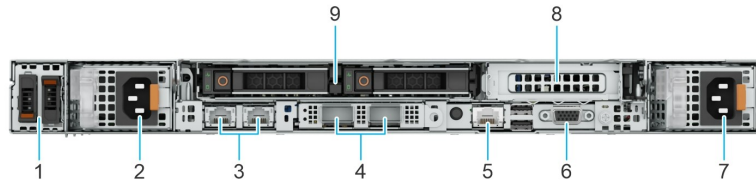





Figure 5. Rear view of the system with 2 x 2.5-inch rear drive module

Table 5. Rear view of the system with 2 x 2.5-inch rear drive module

| Item | Ports, panels, or slots | Icon | Description |
|------|--------------------------------------|---|--|
| 1 | BOSS | N/A | Insert BOSS blank when BOSS module is not used. |
| 2 | Power supply unit (PSU1) |  | PSU1 is the primary PSU of the system. |
| 3 | NIC ports |  | The NIC ports that are integrated on the LOM card provide network connectivity which is connected to the system board. |
| 4 | OCP NIC card | N/A | The OCP NIC card supports OCP 3.0. The NIC ports are integrated on the OCP card which is connected to the system board. |
| 5 | Dedicated iDRAC9 Ethernet port |  | Enables you to remotely access iDRAC. For more information, see the Integrated <i>Dell Remote Access Controller User's Guide</i> at www.dell.com/poweredgemanuals . |
| 6 | VGA port | N/A | Enables you to connect a display device to the system. |
| 7 | Power supply unit (PSU2) |  | PSU2 is the secondary PSU of the system. |
| 8 | PCIe expansion card riser 3 (slot 3) | N/A | The expansion card riser enables you to connect PCI Express expansion cards. For more information , see the Expansion card installation guidelines section. |
| 9 | Drives | N/A | Enables you to install drives that are supported on your system. |

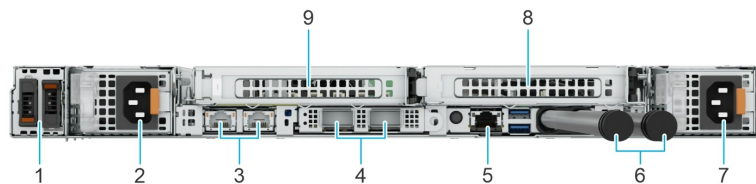

Figure 6. Rear view of the system with Direct Liquid Cooling module

Table 6. Rear view of the system with Direct Liquid Cooling module





| Item | Ports, panels, or slots | Icon | Description |
|------|--------------------------|---|---|
| 1 | BOSS | N/A | Insert BOSS blank when BOSS module is not used. |
| 2 | Power supply unit (PSU1) |  | PSU1 is the primary PSU of the system. |
| 3 | NIC ports | N/A | The NIC ports that are integrated on the LOM card provide network connectivity which is connected to the system board. |
| 4 | OCP NIC card |  | The OCP NIC card supports OCP 3.0. The NIC ports are integrated on the OCP card which is connected to the system board. |

Table 6. Rear view of the system with Direct Liquid Cooling module (continued)

| Item | Ports, panels, or slots | Icon | Description |
|------|--------------------------------------|---|--|
| 5 | Dedicated iDRAC9 Ethernet port |  | Enables you to remotely access iDRAC. For more information, see the Integrated <i>Dell Remote Access Controller User's Guide</i> at www.dell.com/poweredgemanuals . |
| 6 | Coolant tubes | N/A | Enables you to install the coolant tubes for Direct Liquid Cooling feature. |
| 7 | Power supply unit (PSU2) |  | PSU2 is the secondary PSU of the system. |
| 8 | PCIe expansion card riser 3 (slot 3) | N/A | The expansion card riser enables you to connect PCI Express expansion cards. For more information, see the Expansion card installation guidelines section. |
| 9 | PCIe expansion card riser 1 (slot 1) | N/A | The expansion card riser enables you to connect PCI Express expansion cards. For more information, see the Expansion card installation guidelines section. |

 **NOTE:** For more information about ports, panels, and slots, see the Technical specifications section.

Inside the system

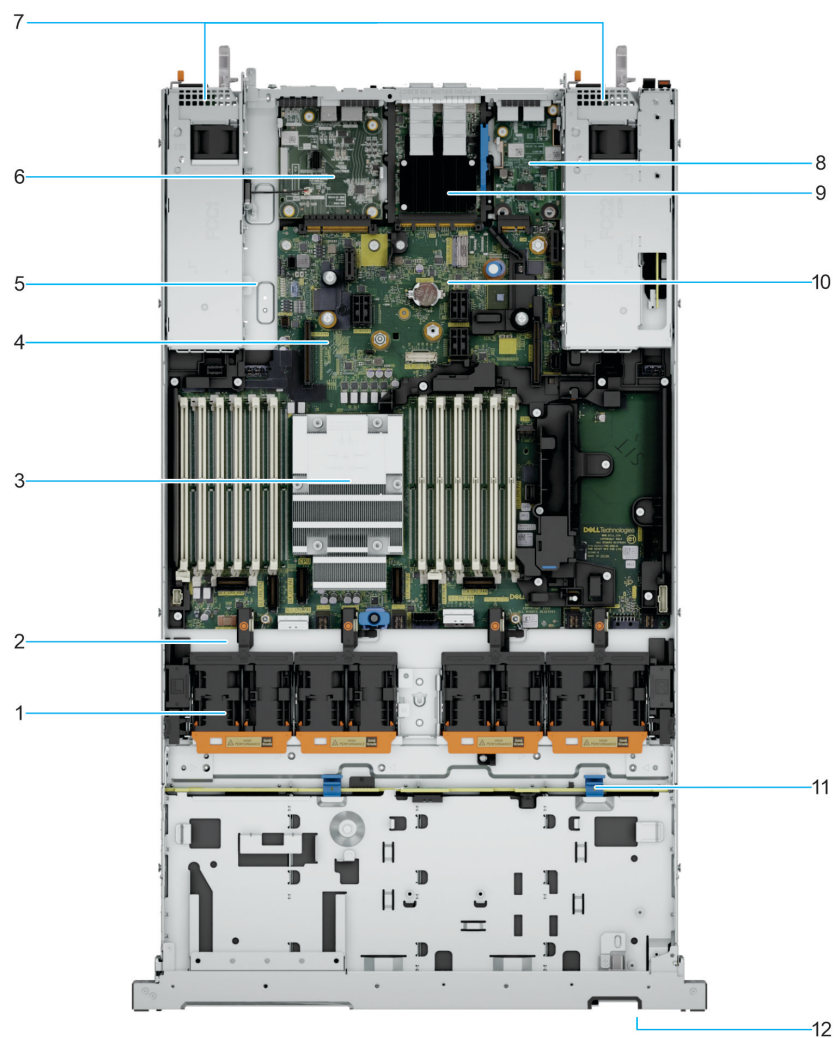

Figure 7. Inside the system without Risers

1. Cooling fan cage assembly
2. Fan power connector
3. Processor
4. System board
5. Guiding mechanism to guide Riser module
6. Rear I/O board
7. Power Supply Units (PSU 1 and 2)
8. LOM card
9. OCP card
10. Coin cell battery

- 11. Drive backplane with latch
- 12. Information Tag

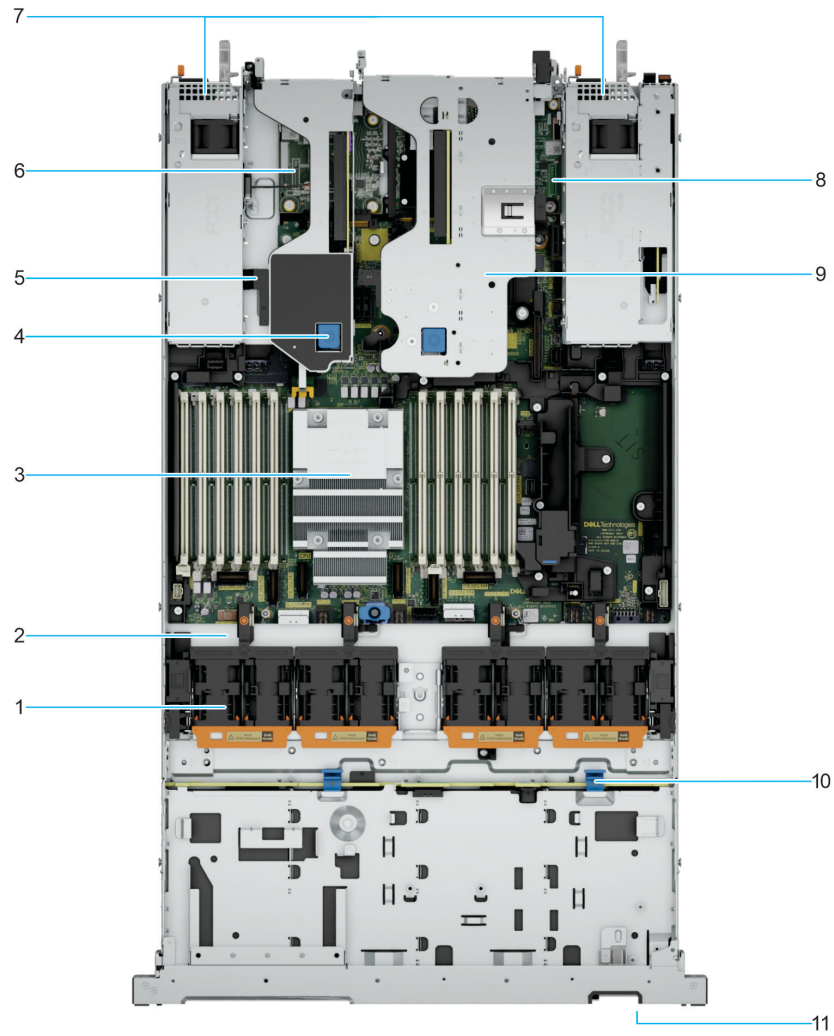

Figure 8. Inside the system with Risers

- 1. Cooling fan cage assembly
- 2. Fan power connector
- 3. Processor
- 4. Latch mechanism to engage Riser module
- 5. Guiding mechanism to guide Riser module
- 6. Riser 3
- 7. Power Supply Units (PSU 1 and 2)
- 8. System board
- 9. Riser 2
- 10. Drive backplane with latch
- 11. Information Tag

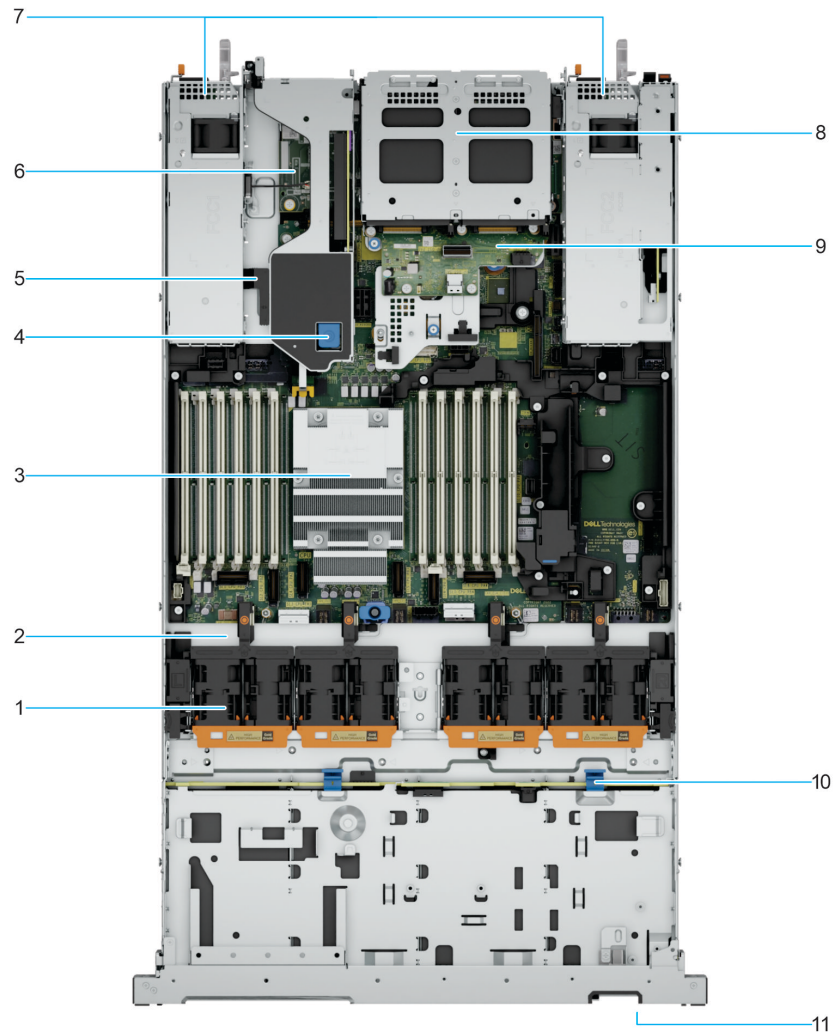

Figure 9. Inside the system with Risers + Rear 2 x 2.5-inch module

1. Cooling fan cage assembly
2. Fan power connector
3. Processor
4. Latch mechanism to engage Riser module
5. Guiding mechanism to guide Riser module
6. Riser 3
7. Power Supply Units (PSU 1 and 2)
8. 2 x 2.5-inch rear drives
9. Riser 2
10. Drive backplane with latch
11. Information Tag

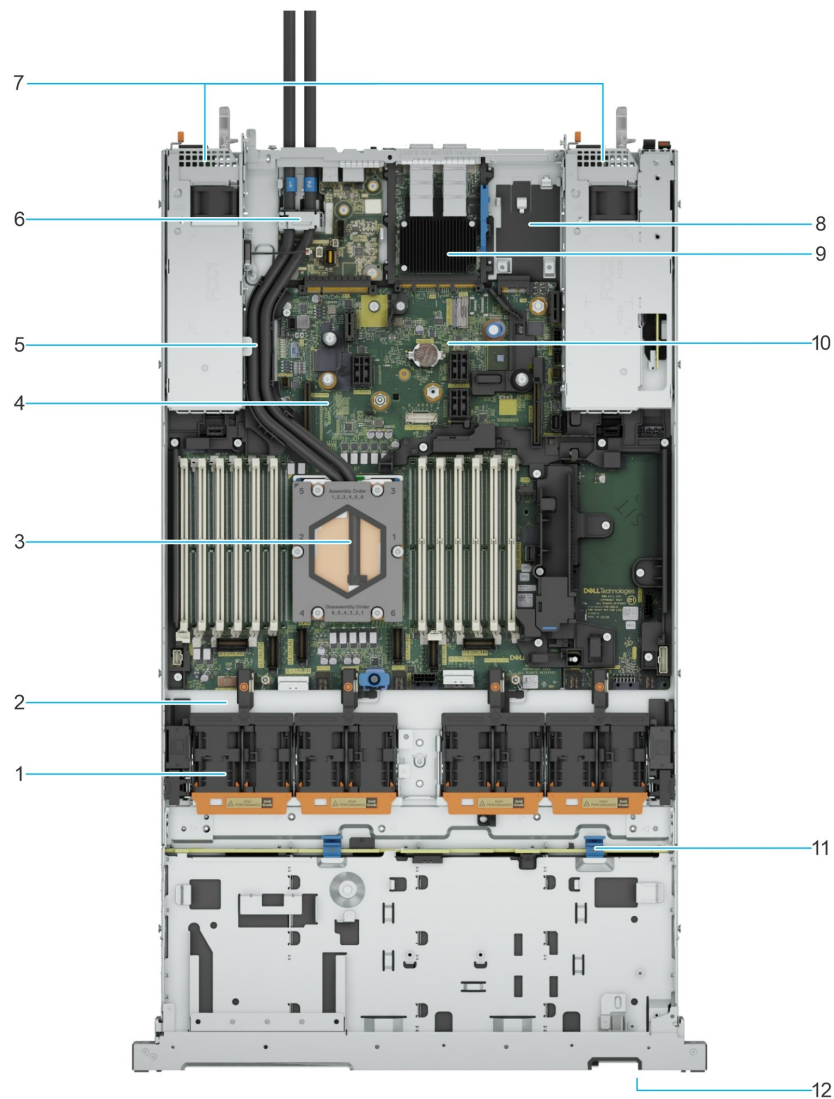

Figure 10. Inside the system with Direct Liquid Cooling

1. Cooling fan cage assembly
2. Fan power connector
3. Liquid cooling module
4. System board
5. Coolant tubes
6. Coolant tube/sensor cable holder
7. Power Supply Units (PSU 1 and 2)
8. LOM card
9. OCP card
10. Coin cell battery
11. Drive backplane with latch
12. Information Tag

Locating the Express Service Code and Service Tag

The unique Express Service Code and Service Tag are used to identify the system. The information tag is located in the front of the system that includes system information such as Service Tag, Express Service Code, Manufacture date, NIC, MAC address, QRL label, and so on. If you have opted for the secure default access to iDRAC, the Information tag also contains the iDRAC secure default password. If you have opted for iDRAC Quick Sync 2, the Information tag also contains the OpenManage Mobile (OMM) label, where administrators can configure, monitor, and troubleshoot the PowerEdge servers.

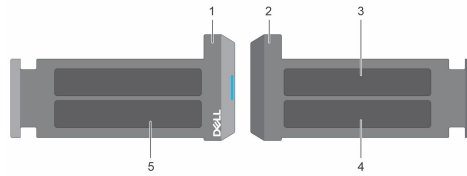

Figure 11. Locating the Express Service Code and Service tag

- | | |
|---|--|
| 1. Information tag (front view) | 2. Information tag (back view) |
| 3. OpenManage Mobile (OMM) label | 4. iDRAC MAC address and iDRAC secure password label |
| 5. Service Tag, Express Service Code, QRL label | |

The Mini Enterprise Service Tag (MEST) label is located on the rear of the system that includes Service Tag (ST), Express Service Code (Exp Svc Code), and Manufacture Date (Mfg. Date). The Exp Svc Code is used by Dell EMC to route support calls to the appropriate personnel.

Alternatively, the Service Tag information is located on a label on left wall of the chassis.

System information label

The system information label is located on the back side of the system cover.

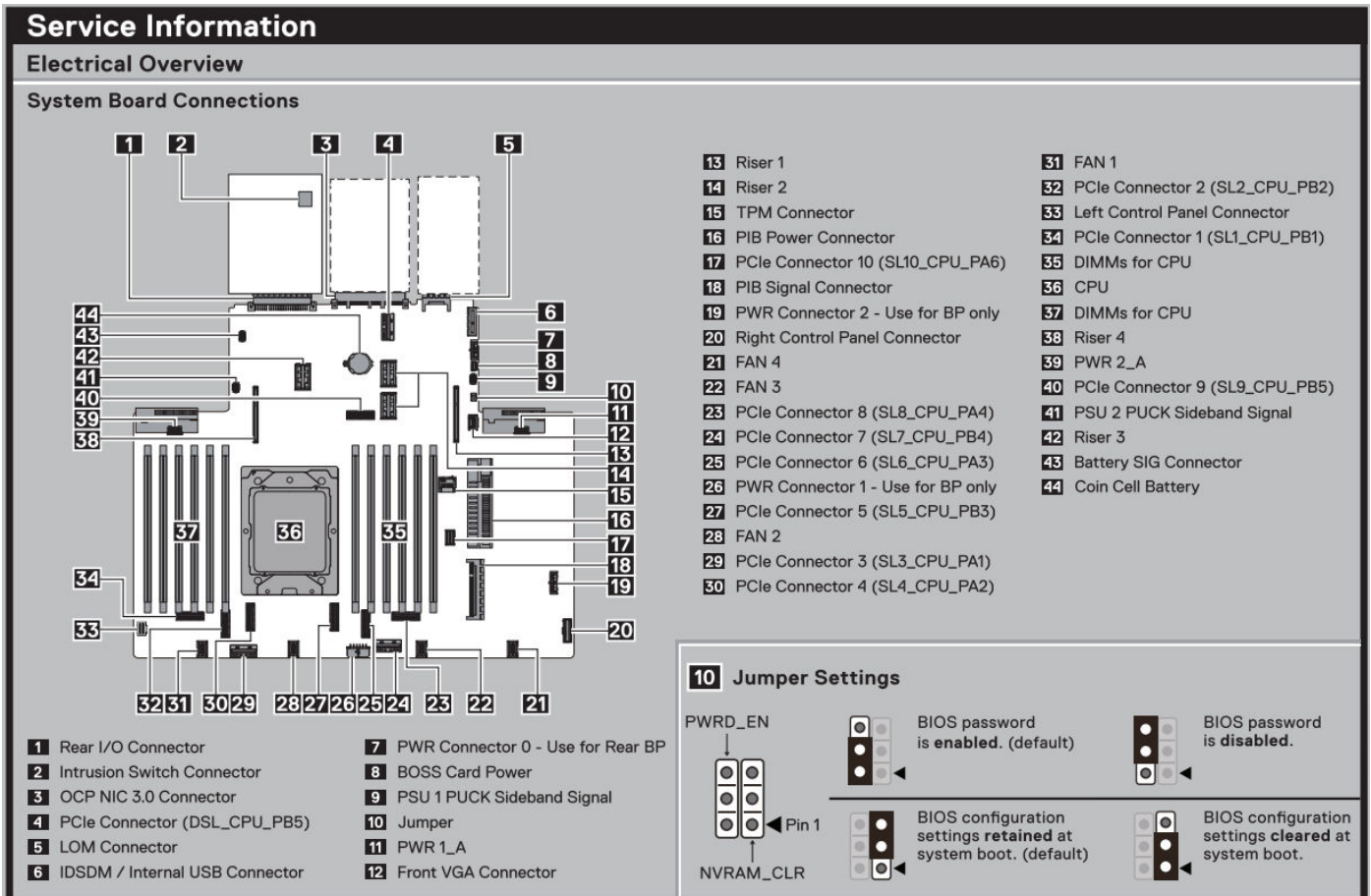

Figure 12. Service information

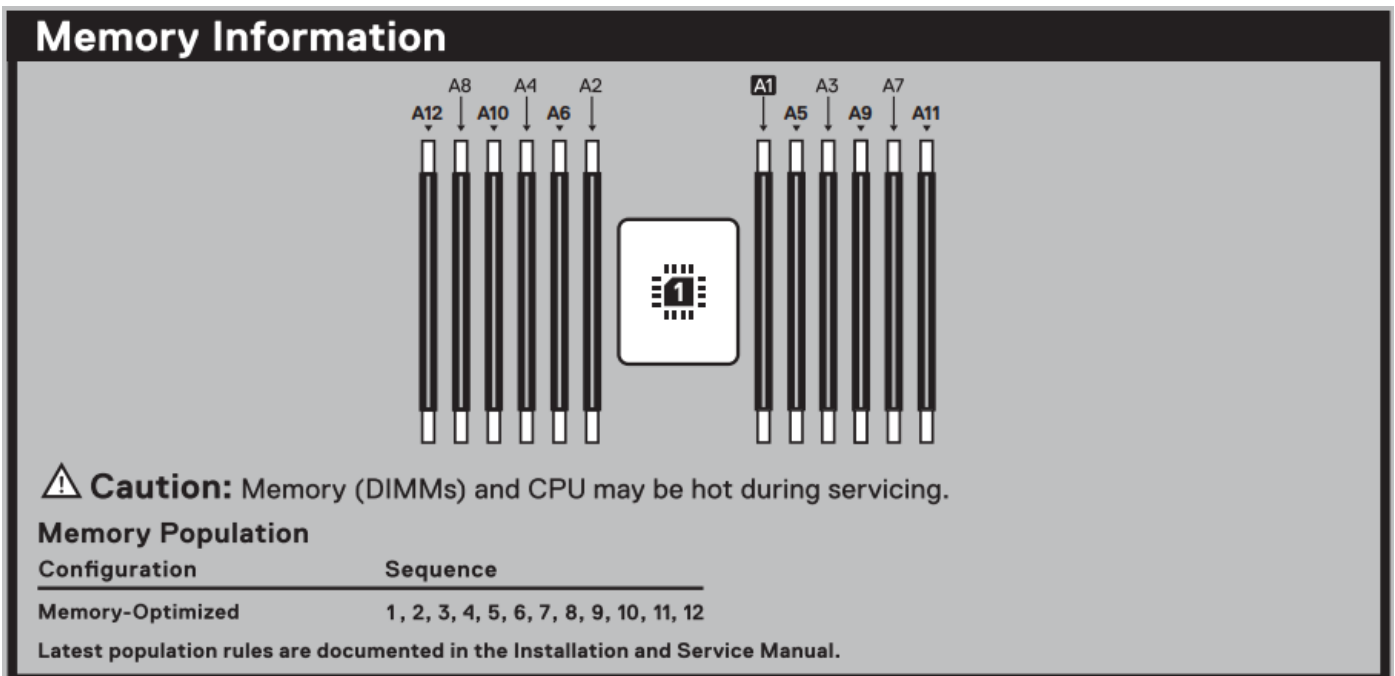

Figure 13. Memory information

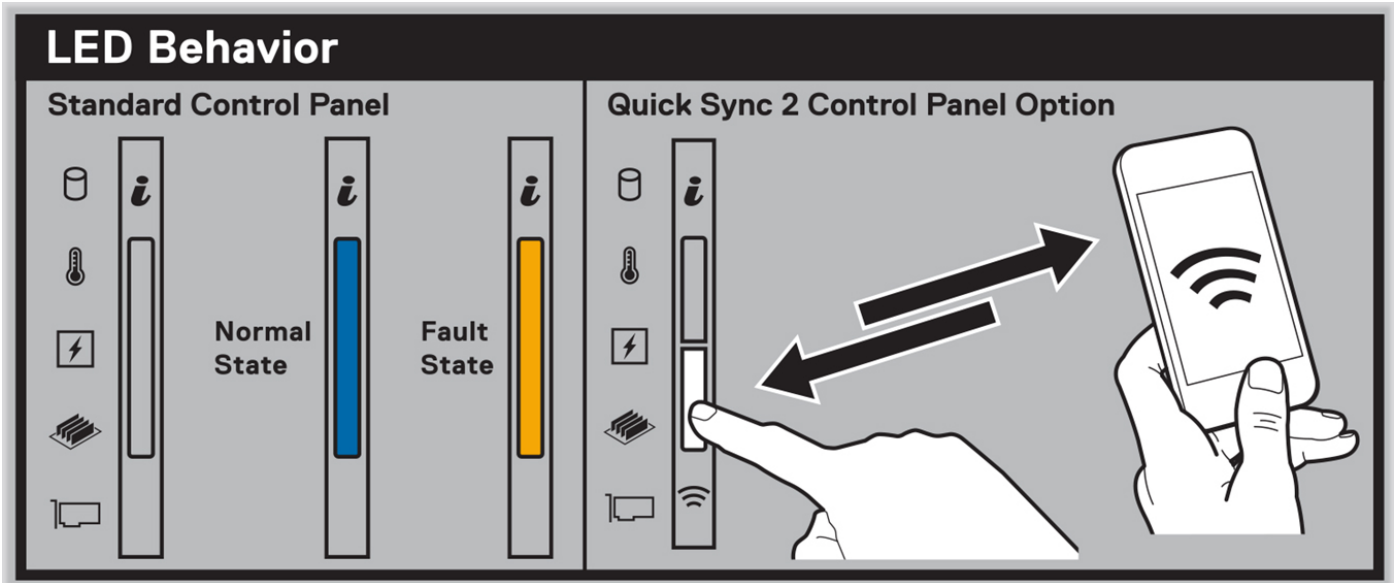

Figure 14. LED behavior

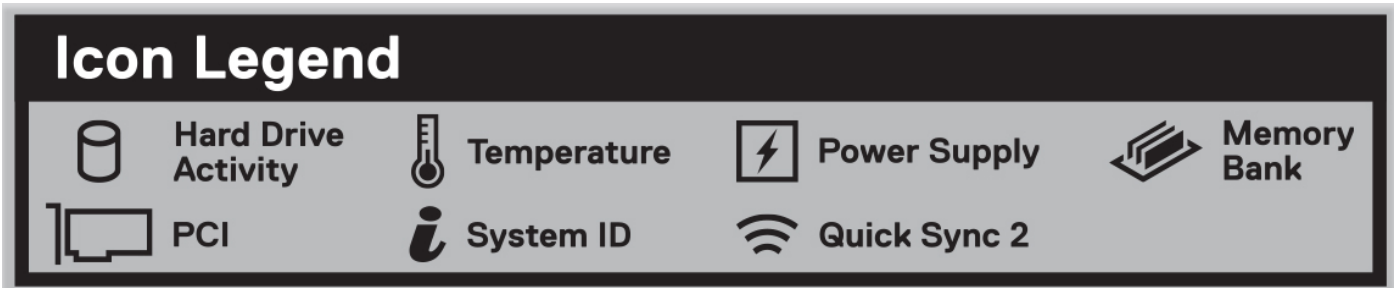

Figure 15. Icon legend

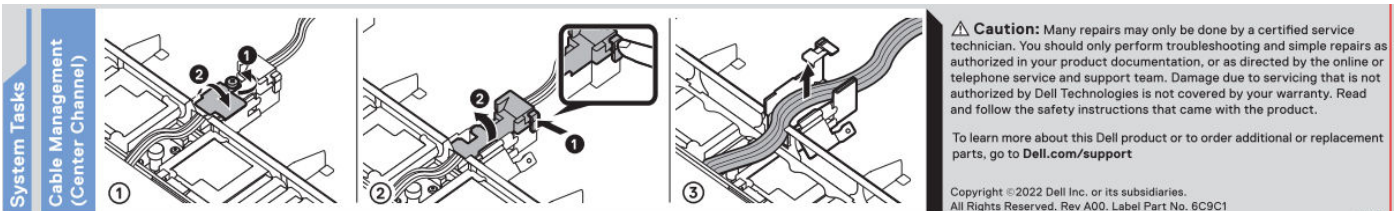

Figure 16. System tasks

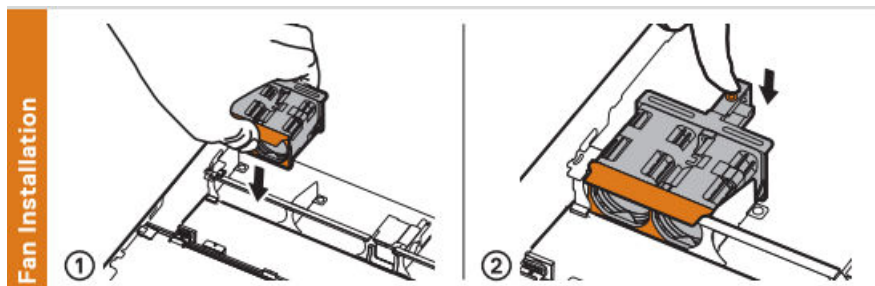

Figure 17. Fan



Figure 18. Express service tag

Rail sizing and rack compatibility matrix

For specific information about the rail solutions compatible with your system, see the *Dell Enterprise Systems Rail Sizing and Rack Compatibility Matrix* available at https://i.dell.com/sites/csdocuments/Business_solutions_engineering-Docs_Documents/en/rail-rack-matrix.pdf.

The document provides the information that is listed below:

- Specific details about rail types and their functionalities.
- Rail adjustability range for various types of rack mounting flanges.
- Rail depth with and without cable management accessories.
- Types of racks supported for various types of rack mounting flanges.

Technical specifications

The technical and environmental specifications of your system are outlined in this section.

Topics:

- Chassis dimensions
- System weight
- Processor specifications
- PSU specifications
- Supported operating systems
- Cooling fan specifications
- System battery specifications
- Expansion card riser specifications
- Memory specifications
- Storage controller specifications
- Drives
- Ports and connectors specifications
- Video specifications
- Environmental specifications

Chassis dimensions

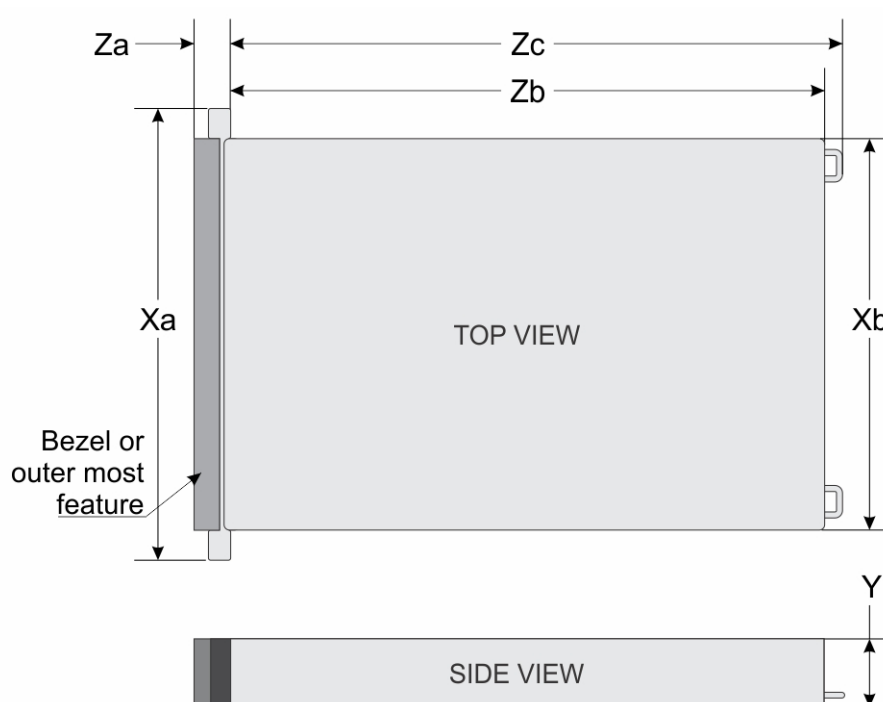

Figure 19. Chassis dimensions

Table 7. PowerEdge R6615 chassis dimensions

| Drives | Xa | Xb | Y | Za with bezel | Za without bezel | Zb | Zc |
|---------------------|-------------------------|-------------------------|------------------------|----------------------------------|-------------------------------------|---|--|
| 8 drives | 482.0 mm (18.97 inches) | 434.0 mm (17.08 inches) | 42.8 mm (1.685 inches) | 35.84 mm (1.4 inches) With bezel | 22.0 mm (0.87 inches) Without bezel | 700.7 mm (27.58 inches) Ear to rear wall | 736.29 mm (28.99 inches) Ear to PSU handle |
| 4 drives, 10 drives | 482.0 mm (18.97 inches) | 434.0 mm (17.08 inches) | 42.8 mm (1.685 inches) | 35.84 mm (1.4 inches) With bezel | 22.0 mm (0.87 inches) Without bezel | 751.48 mm (29.59 inches) Ear to rear wall | 787.05 mm (30.99 inches) Ear to PSU handle |

NOTE: Zb is the nominal rear wall external surface where the system board I/O connectors reside.

System weight

Table 8. PowerEdge R6615 system weight

| System configuration | Maximum weight (with all drives/SSDs) |
|---|---------------------------------------|
| A server with fully populated drives | 20.2 kg (44.53 lbs) |
| A server without drives and PSU installed | 17.4 kg (38.36 lbs) |

Processor specifications

Table 9. PowerEdge R6615 processor specifications

| Supported processor | Number of processors supported |
|---|--------------------------------|
| AMD EPYC 4 th Generation 9004 Series processor | One |

PSU specifications

The PowerEdge R6615 system supports up to two AC or DC power supply units (PSUs).

Table 10. PSU specifications

| PSU | Class | Heat dissipation (maximum) (BTU/hr) | Frequency (Hz) | Voltage | AC | | DC | Current (A) |
|-------------------|----------|-------------------------------------|----------------|----------------|-------------------------------|-----------------------------|--------|-------------|
| | | | | | High line wattage 200 V-240 V | Low line wattage 100 -120 V | | |
| 700 W mixed mode | Titanium | 2625 | 50/60 | 200-240 V AC | 700 W | N/A | N/A | 4.1 |
| | N/A | 2625 | N/A | 240 V DC | N/A | N/A | 700 W | 3.4 |
| 800 W mixed mode | Platinum | 3000 | 50/60 | 100-240 V AC | 800 W | 800 W | N/A | 9.2-4.7 |
| | N/A | 3000 | N/A | 240 V DC | N/A | N/A | 800 W | 3.8 |
| 1100 W DC | N/A | 4265 | N/A | -48 - -60 V DC | N/A | N/A | 1100 W | 27 |
| 1100 W mixed mode | Titanium | 4125 | 50/60 | 100-240 V AC | 1100 W | 1050 W | N/A | 12-6.3 |
| | N/A | 4125 | N/A | 240 V DC | N/A | N/A | 1100 W | 5.2 |

Table 10. PSU specifications (continued)

| PSU | Class | Heat dissipation (maximum) (BTU/hr) | Frequency (Hz) | Voltage | AC | | DC | Current (A) |
|-------------------|----------|-------------------------------------|----------------|--------------|-------------------------------|-----------------------------|--------|-------------|
| | | | | | High line wattage 200 V–240 V | Low line wattage 100 -120 V | | |
| 1400 W mixed mode | Platinum | 5250 | 50/60 | 100-240 V AC | 1400 W | 1050 W | N/A | 12-8 |
| | N/A | 5250 | N/A | 240 V DC | N/A | N/A | 1400 W | 6.6 |
| 1800 W mixed mode | Titanium | 6610 | 50/60 | 200-240 V AC | 1800 W | N/A | N/A | 10 |
| | N/A | 6610 | N/A | 240 V DC | N/A | N/A | 1800 W | 8.2 |

NOTE: If a system with AC 1400 W or 1100 W PSUs operate at low line 100-120 V AC, then the power rating per PSU is derated to 1050 W.

NOTE: Heat dissipation is calculated using the PSU wattage rating.

NOTE: When selecting or upgrading the system configuration, to ensure optimum power utilization, verify the system power consumption with the Enterprise Infrastructure Planning Tool available at [Dell.com/calculator](https://www.dell.com/calculator).

Table 11. PSU power cords

| Form factor | Output | Power cord |
|-----------------|-----------------|------------|
| Redundant 60 mm | 700 W AC | C13 |
| | 800 W AC | C13 |
| | 1100 W AC | C13 |
| | 1100 W -48 V DC | C13 |
| | 1400 W AC | C13 |
| | 1800 W AC | C15 |

NOTE: C13 power cord combined with C14 to C15 jumper power cord can be used to adapt 1800 W PSU.

Supported operating systems

The PowerEdge R6615 system supports the following operating system:

- Canonical Ubuntu Server LTS
- Microsoft Windows Server with Hyper-V
- Red Hat Enterprise Linux
- SUSE Linux Enterprise Server
- VMware ESXi

For more information, go to www.dell.com/ossupport.

Cooling fan specifications

The PowerEdge R6615 system supports up to four high performance gold (HPR Gold) cooling fans.

Table 12. Cooling fan specifications

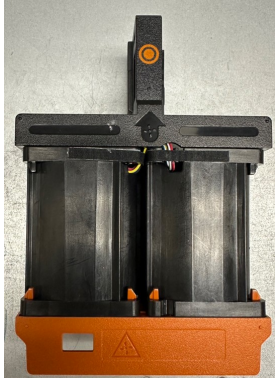
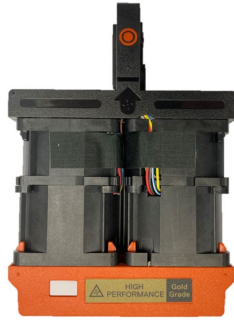
| Fan type | Abbreviation | Also known as | Label color | Label image |
|----------------------------|--------------|---------------|-------------|--|
| Standard fans | STD | STD fans | No label |  |
| High Performance Gold fans | HPR Gold | VHP fans | Gold |  |

System battery specifications

The PowerEdge R6615 system uses one CR 2032 3.0-V lithium coin cell battery.

Expansion card riser specifications

The PowerEdge R6615 system supports up to three PCI express (PCIe) (two Full Height or three Low Profile Gen 4/Gen 5 capable + OCP) Gen5 slots on the system board.

Table 13. Expansion card slots supported on the system board

| PCIe slot | Expansion card riser | Processor Connection | Height | Length | Slot width |
|-----------|----------------------|----------------------|-------------|-------------|-------------|
| Slot 1 | R1Q | Processor 1 | Full Height | Half Length | x16 (Gen 5) |
| Slot 1 | R2A | Processor 1 | Low Profile | Half Length | x8 (Gen 4) |
| Slot 2 | | Processor 1 | Low Profile | Half Length | x8 (Gen 4) |
| Slot 1 | R2T | Processor 1 | Low Profile | Half Length | x16 (Gen 5) |
| Slot 2 | | Processor 1 | Low Profile | Half Length | x16 (Gen 4) |
| Slot 1 | R2U | Processor 1 | Low Profile | Half Length | x16 (Gen 5) |
| Slot 3 | R3A | Processor 1 | Low Profile | Half Length | x16 (Gen 4) |
| Slot 3 | R3P | Processor 1 | Low Profile | Half Length | x16 (Gen 5) |
| Slot 3 | R3S | Processor 1 | Low Profile | Half Length | x16 (Gen 5) |

Table 13. Expansion card slots supported on the system board (continued)

| PCIe slot | Expansion card riser | Processor Connection | Height | Length | Slot width |
|-----------|----------------------|----------------------|-------------|-------------|-------------|
| Slot 2 | R4P | Processor 1 | Full Height | Half Length | x16 (Gen 5) |

PCIe Riser Configuration

The following table describes the supported expansion cards configuration.

Table 14. PCIe Riser Configuration

| Config Number | RSR Configuration | Number of CPUs | PERC type supported | Rear Storage Possible | x8 CPU 1, Slot 1 LP | x8 CPU 1, Slot 2 LP | x16 CPU 1, Slot 1 LP | x16 CPU 1, Slot 2 LP | x16 CPU 1, Slot 3 LP | x16 CPU 1, Slot 1 FH | x16 CPU 1, Slot 2 FH |
|---------------|-------------------|----------------|---------------------|-----------------------|---------------------|---------------------|----------------------|----------------------|----------------------|----------------------|----------------------|
| 0 | No RSR | 1 | Front PERC | No | 0 | 0 | 0 | 0 | 0 | 0 | 0 |
| 1 | R2A+R3A | 1 | Front PERC | No | 1 (Gen 4) | 1 (Gen 4) | 0 | 0 | 1 (Gen 4) | 0 | 0 |
| 2 | R2T+R3P | 1 | Front PERC | No | 0 | 0 | 1 (Gen 5) | 1 (Gen 4) | 1 (Gen 5) | 0 | 0 |
| 3 | R1Q+R4P | 1 | Front PERC | No | 0 | 0 | 0 | 0 | 0 | 1 (Gen 5) | 1 (Gen 5) |
| 4 | R2T | 1 | Front PERC | No | 0 | 0 | 1 (Gen 5) | 1 (Gen 4) | 0 | 0 | 0 |
| 5 | R3P | 1 | Front PERC | Yes | 0 | 0 | 0 | 0 | 1 (Gen 5) | 0 | 0 |
| 6 | R2A | 1 | Front PERC | No | 1 (Gen 4) | 1 (Gen 4) | 0 | 0 | 0 | 0 | 0 |
| 7 | R2U+R3S | 1 | Front PERC | Yes | 0 | 0 | 1 (Gen 5) | 0 | 1 (Gen 5) | 0 | 0 |
| 8 | R2T+R3A | 1 | Front PERC | Yes | 0 | 0 | 1 (Gen 5) | 1 (Gen 4) | 1 (Gen 4) | 0 | 0 |

 **NOTE:** The expansion-card slots are not hot-swappable.

Memory specifications

The PowerEdge R6615 system supports the following memory specifications for optimized operation.

Table 15. Memory specifications

| DIMM type | DIMM rank | DIMM capacity | Single Processor | |
|-----------|-------------|---------------|-------------------------|-------------------------|
| | | | Minimum system capacity | Maximum system capacity |
| RDIMM | Single rank | 16 GB | 16 GB | 192 GB |
| | Dual rank | 32 GB | 32 GB | 384 GB |
| | Dual rank | 64 GB | 64 GB | 768 GB |

Table 16. Memory module sockets

| Memory module sockets | Speed |
|-----------------------|-----------|
| 12, 288-pin | 4800 MT/s |

NOTE: Memory DIMM slots are not hot pluggable.

NOTE: Memory DIMMs used must be of the same type and capacity. Mixing of different capacity DIMMs are not supported.

NOTE: Supports DIMM speed up to 4800 MT/s but could be downclocked by the CPU.

Storage controller specifications

The PowerEdge R6615 system supports the following controller cards:

Table 17. Storage controller cards

| Supported storage controller card |
|---|
| Internal controller <ul style="list-style-type: none">PERC H965iPERC H755NPERC H755PERC H355 |
| External controllers <ul style="list-style-type: none">HBA355e |
| Internal Boot <ul style="list-style-type: none">Boot Optimized Storage Subsystem (BOSS-N1): HWRAID 2 x M.2 NVMe SSDs |
| Software RAID <ul style="list-style-type: none">S160 |
| SAS Hot Bus adapter <ul style="list-style-type: none">HBA355i |

Drives

The PowerEdge R6615 system supports:

- 4 x 3.5-inch hot-swappable SAS or SATA drives
- 8 x 2.5-inch hot-swappable NVMe drives
- 10 x 2.5-inch hot-swappable SAS, SATA or NVMe drives
- 2 x 2.5-inch hot-swappable SAS, SATA rear drives
- Zero drive

NOTE: For more information about how to hot swap NVMe PCIe SSD U.2 device, see the *Dell Express Flash NVMe PCIe SSD User's Guide* at <https://www.dell.com/support> > **Browse all Products** > **Data Center Infrastructure** > **Storage Adapters & Controllers** > **Dell PowerEdge Express Flash NVMe PCIe SSD** > **Documentation** > **Manuals and Documents**.

Ports and connectors specifications

USB ports specifications

Table 18. PowerEdge R6615 USB specifications

| Front | | Rear | | Internal (optional) | |
|---|--------------|-------------------------|--------------|---------------------------------|--------------|
| USB port type | No. of ports | USB port type | No. of ports | USB port type | No. of ports |
| USB 2.0-compliant port | One | USB 3.0-compliant port | One | Internal USB 3.0-compliant port | One |
| iDRAC Direct port (Micro-AB USB 2.0-compliant port) | One | USB 2.0-compliant ports | One | | |

NOTE: The micro USB 2.0 compliant port can only be used as an iDRAC Direct or a management port.



Figure 20. R6615 Front USB



Figure 21. R6615 Rear USB

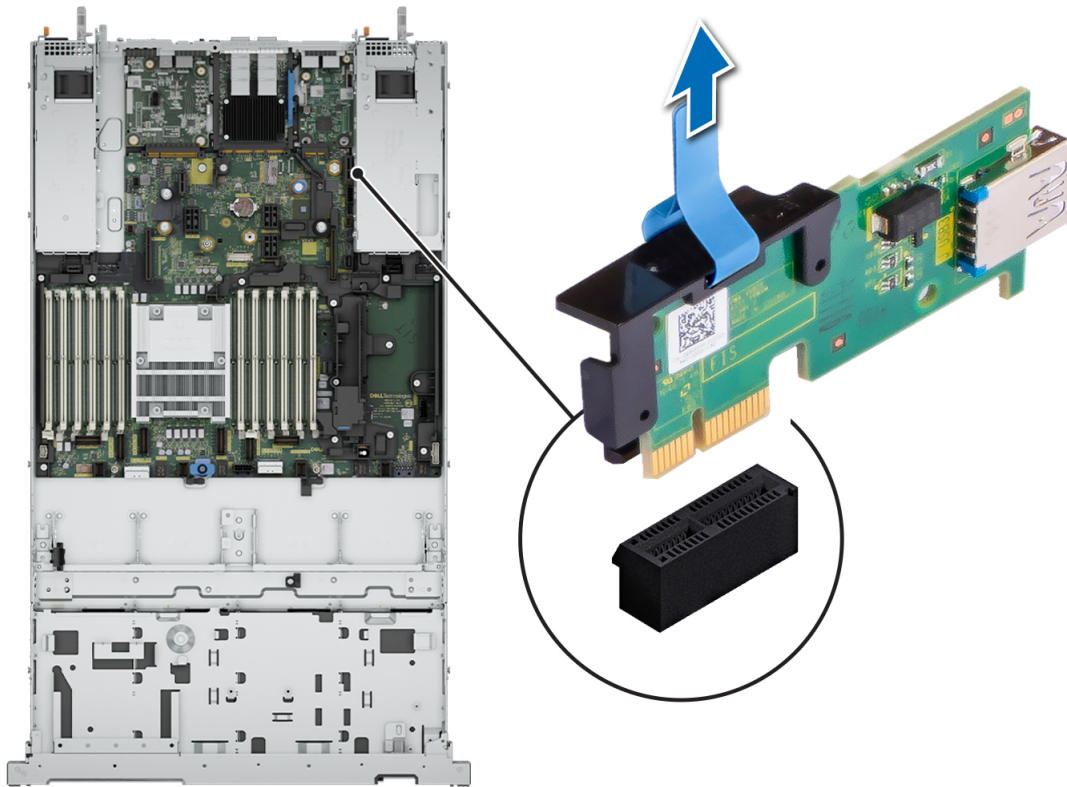

Figure 22. Internal USB Port

NIC port specifications

The PowerEdge R6615 system supports up to two 10/100/1000 Mbps Network Interface Controller (NIC) ports embedded on the LAN on Motherboard (LOM) and integrated on the Open Compute Project (OCP) cards.

Table 19. NIC port specification for the system

| Feature | Specifications |
|-------------------------------|---|
| LOM card (optional) | 1 GB x 2 |
| OCP card (OCP 3.0) (optional) | 1 GbE x 4, 10 GbE x 2, 10 GbE x 4, 25 GbE x 2, 25 GbE x 4 |

NOTE: The system allows either LOM card or an OCP card or both to be installed in the system.

NOTE: On the system board, the supported OCP PCIe width is x8; when x16 PCIe width is installed, it is downgraded to x8.

Serial connector specifications

The PowerEdge R6615 system supports one optional card type serial connector, which is a 9-pin connector, Data Terminal Equipment (DTE), 16550-compliant .

The optional serial connector card is installed similar to an expansion card filler bracket.

VGA ports specifications

The PowerEdge R6615 system supports two DB-15 VGA port one each on the front and back panel.

Video specifications

The PowerEdge R6615 system supports integrated Matrox G200 graphics controller with 16 MB of video frame buffer.

Table 20. Supported video resolution options

| Resolution | Refresh rate (Hz) | Color depth (bits) |
|-------------|-------------------|--------------------|
| 1024 x 768 | 60 | 8, 16, 32 |
| 1280 x 800 | 60 | 8, 16, 32 |
| 1280 x 1024 | 60 | 8, 16, 32 |
| 1360 x 768 | 60 | 8, 16, 32 |
| 1440 x 900 | 60 | 8, 16, 32 |
| 1600 x 900 | 60 | 8, 16, 32 |
| 1600 x 1200 | 60 | 8, 16, 32 |
| 1680 x 1050 | 60 | 8, 16, 32 |
| 1920 x 1080 | 60 | 8, 16, 32 |
| 1920 x 1200 | 60 | 8, 16, 32 |

Environmental specifications

NOTE: For additional information about environmental certifications, refer to the *Product Environmental Datasheet* located with the *Documentation* on www.dell.com/support/home.

Table 21. Continuous Operation Specifications for ASHRAE A2

| Temperature | Specifications |
|---|---|
| Allowable operation | |
| Temperature range for altitudes <= 900 m (<= 2953 ft) | 10 to 35°C (50 to 95°F) with no direct sunlight on the platform |
| Humidity percent range (non-condensing at all times) | 8% RH with -12°C minimum dew point to 80% RH with 21°C (69.8°F) maximum dew point |
| Operational altitude de-rating | Maximum temperature is reduced by 1°C/300 m (1.8°F/984 Ft) above 900 m (2953 Ft) |

Table 22. Continuous Operation Specifications for ASHRAE A3

| Temperature | Specifications |
|---|---|
| Allowable operation | |
| Temperature range for altitudes <= 900 m (<= 2953 ft) | 5 to 40°C (41 to 104°F) with no direct sunlight on the equipment |
| Humidity percent range (non-condensing at all times) | 8% RH with -12°C minimum dew point to 85% RH with 24°C (75.2°F) maximum dew point |
| Operational altitude de-rating | Maximum temperature is reduced by 1°C/175 m (1.8°F/574 Ft) above 900 m (2953 Ft) |

Table 23. Continuous Operation Specifications for ASHRAE A4

| Temperature | Specifications |
|---|---|
| Allowable operation | |
| Temperature range for altitudes <= 900 m (<= 2953 ft) | 5 to 45°C (41 to 113°F) with no direct sunlight on the equipment |
| Humidity percent range (non-condensing at all times) | 8% RH with -12°C minimum dew point to 90% RH with 24°C (75.2°F) maximum dew point |
| Operational altitude de-rating | Maximum temperature is reduced by 1°C/125 m (1.8°F/410 Ft) above 900 m (2953 Ft) |

Table 24. Common Environmental Specifications

| Allowable operation | |
|--|---|
| Maximum temperature gradient (applies to both operation and non-operation) | 20°C in an hour* (36°F in an hour) and 5°C in 15 minutes (9°F in 15 minutes), 5°C in an hour* (9°F in an hour) for tape hardware <i>i</i> NOTE: * - Per ASHRAE thermal guidelines for tape hardware, these are not instantaneous rates of temperature change. |
| Non-operational temperature limits | -40 to 65°C (-40 to 149°F) |
| Non-operational humidity limits | 5% to 95% RH with 27°C (80.6°F) maximum dew point |
| Maximum non-operational altitude | 12,000 meters (39,370 feet) |
| Maximum operational altitude | 3,050 meters (10,006 feet) |

Table 25. Maximum vibration specifications

| Maximum vibration | Specifications |
|-------------------|---|
| Operating | 0.21 G _{rms} at 5 Hz to 500 Hz for 10 minutes (all operation orientations) |
| Storage | 1.88 G _{rms} at 10 Hz to 500 Hz for 15 minutes (all six sides tested) |

Table 26. Maximum shock pulse specifications

| Maximum shock pulse | Specifications |
|---------------------|---|
| Operating | Six consecutively executed shock pulses in the positive and negative x, y, and z axis of 6 G for up to 11 ms |
| Storage | Six consecutively executed shock pulses in the positive and negative x, y, and z axis (one pulse on each side of the system) of 71 G for up to 2 ms |

Particulate and gaseous contamination specifications

The following table defines the limitations that help avoid any equipment damage or failure from particulate and gaseous contamination. If the levels of particulate or gaseous pollution exceed the specified limitations and result in equipment damage or failure, you may need to rectify the environmental conditions. Remediation of environmental conditions is the responsibility of the customer.

Table 27. Particulate contamination specifications

| Particulate contamination | Specifications |
|---------------------------|--|
| Air filtration | Data center air filtration as defined by ISO Class 8 per ISO 14644-1 with a 95% upper confidence limit <i>i</i> NOTE: This condition applies to data center environments only. Air filtration requirements do not apply to IT equipment designed to be used outside a data center, in environments such as an office or factory floor. |

Table 27. Particulate contamination specifications (continued)

| Particulate contamination | Specifications |
|---------------------------|--|
| | <p>i NOTE: Air entering the data center must have MERV11 or MERV13 filtration.</p> |
| Conductive dust | <p>Air must be free of conductive dust, zinc whiskers, or other conductive particles</p> <p>i NOTE: This condition applies to data center and non-data center environments.</p> |
| Corrosive dust | <ul style="list-style-type: none"> Air must be free of corrosive dust Residual dust present in the air must have a deliquescent point less than 60% relative humidity <p>i NOTE: This condition applies to data center and non-data center environments.</p> |

Table 28. Gaseous contamination specifications

| Gaseous contamination | Specifications |
|------------------------------|--|
| Copper coupon corrosion rate | <300 Å/month per Class G1 as defined by ANSI/ISA71.04-2013 |
| Silver coupon corrosion rate | <200 Å/month as defined by ANSI/ISA71.04-2013 |

Thermal air restrictions

Table 29. Cooling components

| Label | Description |
|-----------|----------------------|
| STD | Standard performance |
| HPR Gold | High performance |
| EXT. HSK. | External Heat sink |
| LP | Low profile |
| FH | Full height |

Table 30. Air cooling: Thermal restriction matrix (non-GPU)

| Configuration | | | | No BP | 8 x 2.5-inch U.2 | 4 x 3.5-inch | 10 x 2.5-inch SAS | | 10 x 2.5-inch NVMe |
|---------------------|-------|------------|----|----------------|------------------|----------------|-------------------|------------------|--------------------|
| Rear storage | | | | No Rear Drives | No Rear Drives | No Rear Drives | No Rear Drives | 2.5-inch SAS x 2 | No Rear Drives |
| cTDP | Model | Core Count | | | | | | | |
| CPU TDP/ cTDP | 240 W | 9334 | 32 | 35°C | 35°C | 35°C | 35°C | 35°C | 35°C |
| | 240 W | 9224 | 24 | 35°C | 35°C | 35°C | 35°C | 35°C | 35°C |
| | 240 W | 9254 | 24 | 35°C | 35°C | 35°C | 35°C | 35°C | 35°C |
| | 240 W | 9124 | 16 | 35°C | 35°C | 35°C | 35°C | 35°C | 35°C |
| | 300 W | 9634 | 84 | 35°C | 35°C | Not Supported | 30°C | 30°C | 30°C |
| | 300 W | 9534 | 48 | 35°C | 35°C | | 30°C | 30°C | 30°C |

Table 30. Air cooling: Thermal restriction matrix (non-GPU) (continued)

| Configuration | | | No BP | 8 x 2.5-inch U.2 | 4 x 3.5-inch | 10 x 2.5-inch SAS | | 10 x 2.5-inch NVMe | |
|---------------|-------|---------------|----------------|------------------|----------------|-------------------|------------------|--------------------|------|
| Rear storage | | | No Rear Drives | No Rear Drives | No Rear Drives | No Rear Drives | 2.5-inch SAS x 2 | No Rear Drives | |
| cTDP | Model | Core Count | | | | | | | |
| | 300 W | 9454 / 9454 P | 64 | 35°C | 35°C | | 30°C | 30°C | 30°C |
| | 300 W | 9354 / 9354 P | 32 | 35°C | 35°C | | 30°C | 30°C | 30°C |
| | 400 W | 9654 / 9654 P | 96 | 30°C | 30°C | | Require DLC | Not Supported | |
| | 400 W | 9554 / 9554 P | 64 | Require DLC | | | | | |
| | 400 W | 9474 F | 48 | Require DLC | | | | | |
| | 400 W | 9374 F | 32 | 30°C | 30°C | | | | |
| | 400 W | 9274 F | 21 | 30°C | 30°C | | | | |
| | 400 W | 9174 F | 16 | 30°C | 30°C | | | | |

NOTE: CPU TDP > 300 W, performance drops 10% at 30°C ambient and 5% at 25°C ambient.

Table 31. Air cooling: Thermal restriction matrix (GPU Configuration)

| Configuration | | 8 x 2.5-inch U.2 | 4 x 3.5-inch | 10 x 2.5-inch SAS | 10 x 2.5-inch NVMe |
|---------------|-------|------------------|----------------|-------------------|--------------------|
| Rear storage | | No Rear Drives | No Rear Drives | No Rear Drives | No Rear Drives |
| cTDP | | | | | |
| CPU TDP/ cTDP | 240 W | 35°C | 30°C | 35°C | 35°C |
| | 300 W | 30°C | Not Supported | 30°C | 30°C |

NOTE: For fan type selection, refer the solution strategy under cooling components.

Thermal air restrictions

ASHRAE A3/A4 environment - Air cooling

Table 32. ASHRAE A3/A4 environment - Air cooling

| ASHRAE | ASHRAE A3 / 40C | ASHRAE A4 / 45C |
|---------------|--|----------------------------------|
| Front Storage | 3.5-inch config. is not supported 2.5-inch x 10 is not supported NVME not supported | |
| Fan type | HPR Gold fans are required | |
| CPU | CPU TDP > 240W are not supported | CPU TDP > 200W are not supported |
| Memory | 128GB and higher capacity RDIMMS are not supported. | |
| PCIe card | Non-Dell qualified peripheral cards and consuming power greater than 25W are not supported | |
| GPU | GPU cards are not supported | |
| Rear storage | Not Supported | |
| OCP | Support with 85C active optic cable | Not Supported |
| PSU | Two PSUs are required in redundant mode. System performance may be reduced in the event of a PSU failure | |
| BOSS-N1 | Supported | Not Supported |

ASHRAE A3/A4 environment - Liquid cooling

Table 33. ASHRAE A3/A4 environment - Liquid cooling

| ASHRAE | ASHRAE A3 / 40C | ASHRAE A4 / 45C |
|---------------|--|-----------------|
| Front Storage | 3.5-inch config. is not supported NVME not supported | |
| Fan type | HPR Gold fans are required | |
| Memory | 128GB and higher capacity RDIMMS are not supported. | |
| PCIe card | Non-Dell qualified peripheral cards and consuming power greater than 25W are not supported | |
| GPU | GPU cards are not supported | |
| Rear storage | Not Supported | |
| OCP | Support with 85C active optic cable | Not Supported |
| PSU | Two PSUs are required in redundant mode. System performance may be reduced in the event of a PSU failure | |
| BOSS-N1 | Supported | Not Supported |

Initial system setup and configuration

This section describes the tasks for initial setup and configuration of the Dell system. The section also provides general steps to set up the system and the reference guides for detailed information.

Topics:

- [Setting up the system](#)
- [iDRAC configuration](#)
- [Resources to install operating system](#)

Setting up the system

Perform the following steps to set up the system:

Steps

1. Unpack the system.
2. Install the system into the rack. For more information, see the rail installation and cable management accessory guides relevant to your rail and cable management solution at www.dell.com/poweredgemanuals.
3. Connect the peripherals to the system and the system to the electrical outlet.
4. Power on the system.

For more information about setting up the system, see the *Getting Started Guide* that is shipped with your system.

 **NOTE:** For information about managing the basic settings and features of the system, see the [Pre-operating system management applications](#) chapter.

iDRAC configuration

The Integrated Dell Remote Access Controller (iDRAC) is designed to make you more productive as a system administrator and improve the overall availability of Dell servers. iDRAC alerts you to system issues, helps you to perform remote management, and reduces the need for physical access to the system.

Options to set up iDRAC IP address

To enable communication between your system and iDRAC, you must first configure the network settings based on your network infrastructure. The network settings option is set to **DHCP**, by default.

 **NOTE:** For static IP configuration, you must request for the settings at the time of purchase.

You can set up the iDRAC IP address using one of the interfaces in the table below. For information about setting up iDRAC IP address, see the documentation links provided in the table below.

 **NOTE:** To access iDRAC, ensure that you connect the ethernet cable to the iDRAC dedicated network port or use the iDRAC Direct port by using the micro USB (type AB) cable.

Options to log in to iDRAC

To log in to the iDRAC Web User Interface, open a browser and enter the IP address.

You can log in to iDRAC as:

- iDRAC user

- Microsoft Active Directory user
- Lightweight Directory Access Protocol (LDAP) user

In the login screen displayed, if you have opted for secure default access to iDRAC, the default username is `root` and enter the iDRAC secure default password available on back of the Information Tag. If you opted for legacy password, use the iDRAC legacy username and password - `root` and `calvin`, the iDRAC default password will be blank on the information tag. Then you will be prompted and required to create a password of your choice before proceeding. You can also log in by using your Single Sign-On or Smart Card.

NOTE: Ensure that you change the default username and password after setting up the iDRAC IP address.

For more information about logging in to the iDRAC and iDRAC licenses, see the latest *Integrated Dell Remote Access Controller User's Guide* at www.dell.com/idracmanuals.

NOTE: To determine the most recent iDRAC release for your platform and for latest documentation version, see KB article <https://www.dell.com/support/article/sln308699>.

You can also access iDRAC using command-line protocol - RACADM. For more information, see the *Integrated Dell Remote Access Controller RACADM CLI Guide* available at <https://www.dell.com/idracmanuals>.

You can also access iDRAC using automation tool - Redfish API. For more information, see the *Integrated Dell Remote Access Controller User's Guide Redfish API Guide* available at <https://developer.dell.com>.

Resources to install operating system

If the system is shipped without an operating system, you can install a supported operating system by using one of the resources provided in the table below. For information about how to install the operating system, see the documentation links provided in the table below.

Table 34. Resources to install the operating system

| Resource | Documentation links |
|----------------------|--|
| iDRAC | <i>Integrated Dell Remote Access Controller User's Guide</i> at https://www.dell.com/idracmanuals or for system specific <i>Integrated Dell Remote Access Controller User's Guide</i> , go to https://www.dell.com/poweredgemanuals > Product Support page of your system > Documentation . NOTE: To determine the most recent iDRAC release for your platform and for latest documentation version, see KB article at https://www.dell.com/support/article/sln308699 . |
| Lifecycle Controller | <i>Dell Lifecycle Controller User's Guide</i> at https://www.dell.com/idracmanuals or for system specific <i>Dell Lifecycle Controller User's Guide</i> , go to https://www.dell.com/poweredgemanuals > Product Support page of your system > Documentation . Dell recommends using Lifecycle Controller to install the OS, since all required drivers are installed on the system. NOTE: To determine the most recent iDRAC release for your platform and for latest documentation version, see KB article at https://www.dell.com/support/article/sln308699 . |

Options to download drivers and firmware

You can download drivers and firmware from the FTP site: <https://mft.dell.com/R6615>. For more information about username and password, contact your TAM (Tech Account Manager).

Options to download and install OS drivers

You can choose any one of the following options to download and install OS drivers. For information about how to download or install OS drivers, see the documentation links provided in the table below.

Table 35. Options to download and install OS drivers

| Option | Documentation |
|-------------------|---|
| Dell support site | Downloading drivers and firmware section. |

Table 35. Options to download and install OS drivers (continued)

| Option | Documentation |
|---------------------|---|
| iDRAC virtual media | <p><i>Integrated Dell Remote Access Controller User's Guide</i> at https://www.dell.com/idracmanuals or for system specific <i>Integrated Dell Remote Access Controller User's Guide</i>, go to https://www.dell.com/poweredgemanuals > Product Support page of your system > Documentation .</p> <p>NOTE: To determine the most recent iDRAC release for your platform and for latest documentation version, see https://www.dell.com/support/article/sln308699.</p> |

Downloading drivers and firmware

It is recommended that you download and install the latest BIOS, drivers, and systems management firmware on the system.

Prerequisites

Ensure that you clear the web browser cache before downloading the drivers and firmware.

Steps

1. Go to www.dell.com/support/drivers.
2. Enter the Service Tag of the system in the **Enter a Dell Service Tag, Dell Product ID or Model** field, and then press Enter.

NOTE: If you do not have the Service Tag, click **Browse all products**, and navigate to your product.

3. On the displayed product page, click **Drivers & Downloads**.
On the **Drivers & Downloads** page, all drivers that are applicable to the system are displayed.
4. Download the drivers to a USB drive, CD, or DVD.

Pre-operating system management applications

You can manage basic settings and features of a system without booting to the operating system by using the system firmware.

Options to manage the pre-operating system applications

You can use any one of the following options to manage the pre-operating system applications:

- System Setup
- Dell Lifecycle Controller
- Boot Manager
- Preboot Execution Environment (PXE)

Topics:

- [System Setup](#)
- [Dell Lifecycle Controller](#)
- [Boot Manager](#)
- [PXE boot](#)

System Setup

Using the **System Setup** option, you can configure the BIOS settings, iDRAC settings, and device settings of the system.

You can access system setup by using any one of the following interfaces:

- Graphical User interface — To access go to iDRAC Dashboard, click **Configuration**, and click **BIOS Settings**.
- Text browser — The browser is enabled by using Console Redirection.

To view **System Setup**, power on the system, press F2, and click **System Setup Main Menu**.

 **NOTE:** If the operating system begins to load before you press F2, wait for the system to finish booting, and then restart the system and try again.

The **System Setup Main Menu** screen details are described as follows:

Table 36. System Setup Main Menu

| Option | Description |
|------------------------|---|
| System BIOS | Enables you to configure the BIOS settings. |
| iDRAC Settings | Enables you to configure the iDRAC settings. The iDRAC settings utility is an interface to set up and configure the iDRAC parameters by using UEFI (Unified Extensible Firmware Interface). You can enable or disable various iDRAC parameters by using the iDRAC settings utility. For more information about this utility, see <i>Integrated Dell Remote Access Controller User's Guide</i> at www.dell.com/poweredgemanuals . |
| Device Settings | Enabled you to configure device settings for devices such as storage controllers or network cards. |

System BIOS

To view the **System BIOS** screen, power on the system, press F2, and click **System Setup Main Menu > System BIOS**.

Table 37. System BIOS details

| Option | Description |
|--------------------------------|---|
| System Information | Provides information about the system such as the system model name, BIOS version, and Service Tag. |
| Memory Settings | Specifies information and options related to the installed memory. |
| Processor Settings | Specifies information and options related to the processor such as speed and cache size. |
| SATA Settings | Specifies options to enable or disable the integrated SATA controller and ports. |
| NVMe Settings | Specifies options to change the NVMe settings. If the system contains the NVMe drives that you want to configure in a RAID array, you must set both this field and the Embedded SATA field on the SATA Settings menu to RAID mode. You might also need to change the Boot Mode setting to UEFI . Otherwise, you should set this field to Non-RAID mode. |
| Boot Settings | Specifies options to specify the Boot mode (BIOS or UEFI). Enables you to modify UEFI and BIOS boot settings. |
| Network Settings | Specifies options to manage the UEFI network settings and boot protocols. Legacy network settings are managed from the Device Settings menu.  NOTE: Network Settings are not supported in BIOS boot mode. |
| Integrated Devices | Specifies options to manage integrated device controllers and ports, specifies related features, and options. |
| Serial Communication | Specifies options to manage the serial ports, its related features, and options. |
| System Profile Settings | Specifies options to change the processor power management settings, memory frequency. |
| System Security | Specifies options to configure the system security settings, such as system password, setup password, Trusted Platform Module (TPM) security, and UEFI secure boot. It also manages the power button on the system |
| Redundant OS Control | Sets the redundant OS information for redundant OS control. |
| Miscellaneous Settings | Specifies options to change the system date and time. |

System Information

To view the **System Information** screen, power on the system, press F2, and click **System Setup Main Menu > System BIOS > System Information**.

Table 38. System Information details

| Option | Description |
|--|---|
| System Model Name | Specifies the system model name. |
| System BIOS Version | Specifies the BIOS version installed on the system. |
| System Service Tag | Specifies the system Service Tag. |
| System Manufacturer | Specifies the name of the system manufacturer. |
| System Manufacturer Contact Information | Specifies the contact information of the system manufacturer. |

Table 38. System Information details (continued)

| Option | Description |
|--------------------------------|--|
| System CPLD Version | Specifies the current version of the system complex programmable logic device (CPLD) firmware. |
| UEFI Compliance Version | Specifies the UEFI compliance level of the system firmware. |
| AGESA Version | Specifies the AGESA reference code version. |
| SMU Version | Specifies the SMU firmware version. |
| MPIO Version | Specifies the MPIO firmware version. |

Memory Settings

To view the **Memory Settings** screen, power on the system, press F2, and click **System Setup Main Menu > System BIOS > Memory Settings**.

Table 39. Memory Settings details

| Option | Description |
|---|---|
| System Memory Size | Specifies the memory size in the system. |
| System Memory Type | Specifies the type of memory installed in the system. |
| System Memory Speed | Specifies the system memory speed. |
| Video Memory | Specifies the amount of video memory. |
| System Memory Testing | Specifies whether the system memory tests are run during system boot. The two options available are Enabled and Disabled . This option is set to Disabled by default. |
| DRAM Refresh Delay | By enabling the CPU memory controller to delay running the REFRESH commands, you can improve the performance for some workloads. By minimizing the delay time, it is ensured that the memory controller runs the REFRESH command at regular intervals. For Intel-based servers, this setting only affects systems configured with DIMMs which use 8 Gb density DRAMs. This option is set to Minimum by default. |
| DIMM Self Healing(Post Package Repair) on Uncorrectable Memory Error | Enables or disables Post Package Repair (PPR) on Uncorrectable Memory Error. This option is set to Enabled by default. |
| Correctable Error Logging | Enables or disables correctable error logging. This option is set to Disabled by default. |

Processor Settings

To view the **Processor Settings** screen, power on the system, press F2, and click **System Setup Main Menu > System BIOS > Processor Settings**.

Table 40. Processor Settings details

| Option | Description |
|----------------------------------|---|
| Logical Processor | Each processor core supports up to two logical processors. If this option is set to Enabled , the BIOS displays all the logical processors. If this option is set to Disabled , the BIOS displays only one logical processor per core. This option is set to Enabled by default. |
| Virtualization Technology | Enables or disables the virtualization technology for the processor. This option is set to Enabled by default. |

Table 40. Processor Settings details (continued)

| Option | Description |
|---|--|
| IOMMU Support | Enable or Disable IOMMU support. It is required to create IVRS ACPI table. This option is set to Enabled by default. |
| Kernel DMA Protection | When this option is set to Enabled, using IOMMU, BIOS, and the Operating System will enable direct memory access protection for DMA capable peripheral devices. Enable IOMMU Support to use this option. This option is set to Disabled by default. When set to Enabled by using Virtualization Technology, BIOS and Operating System will enable direct memory access protection for DMA capable peripheral devices. Enable Virtualization Technology to use this option. |
| L1 Stream HW Prefetcher | Enables or disables the L1 stream hardware prefetcher. This option is set to Enabled by default. |
| L2 Stream HW Prefetcher | Enables or disables the L2 stream hardware prefetcher. This option is set to Enabled by default. |
| L1 Stride Prefetcher | Enables or disables the L1 stride prefetcher. This option is set to Enabled by default, as it optimizes overall workload. i NOTE: This option is only available for 3rd Generation AMD EPYC processors. |
| L1 Region Prefetcher | Enables or disables the L1 region prefetcher. This option is set to Enabled by default, as it optimizes overall workload. i NOTE: This option is only available for 3rd Generation AMD EPYC processors. |
| L2 Up Down Prefetcher | Enables or disables the L2 up down prefetcher. This option is set to Enabled by default, as it optimizes overall workload. i NOTE: This option is only available for 3rd Generation AMD EPYC processors. |
| MADT Core Enumeration | Specifies the MADT Core Enumeration. This option is set to Linear by default. |
| NUMA Nodes Per Socket | Specifies the number of NUMA nodes per socket. This option is set to 1 by default. |
| L3 cache as NUMA Domain | Enables or disables the L3 cache as NUMA Domain. This option is set to Disabled by default. |
| Secure Memory Encryption | Enables or disables the AMD secure encryption features such as SME and Secure Encrypted Virtualization (SEV) . It also determines if other secure encryption features such as TSME and SEV-SNP can be enabled. This option is set to Disabled by default. i NOTE: This option is only available for 3rd Generation AMD EPYC processors. |
| Minimum SEV non-ES ASID | Determines the number of Secure Encrypted Virtualization ES and non-ES available Address Space IDs. This option is set to 1 by default. |
| Transparent Secure Memory Encryption | Enables or disables the TSME . TSME is always-on memory encryption that does not require OS or hypervisor support. This option is set to Disabled by default. <ul style="list-style-type: none"> • If the OS supports SME, do not enable this field. • If the hypervisor supports SEV, do not enable this field. Enabling TSME affects the system memory performance. |

Table 40. Processor Settings details (continued)

| Option | Description |
|-------------------------------------|--|
| Configurable TDP | Allows the reconfiguration of the processor Thermal Design Power (TDP) levels based on the power and thermal delivery capabilities of the system. TDP refers to the maximum amount of power the cooling system is required to dissipate. This option is set to Maximum by default. i NOTE: This option is only available on certain SKUs of the processors, and the number of alternative levels varies as well. |
| x2APIC Mode | Enables or disables x2APIC mode. This option is set to Enabled by default. i NOTE: For two CPU 64 cores configuration, x2APIC mode is not switchable if 256 threads are enabled (BIOS settings: All CCD, cores, and logical processors enabled). |
| Number of CCDs per Processor | Controls the number of enabled CCDs in each processor. This option is set to All by default. |
| Number of Cores per CCD | Specifies the number of cores per CCD. This option is set to All by default. |
| Processor Core Speed | Specifies the maximum core frequency of the processor. |
| Processor n | i NOTE: Depending on the number of CPUs, there might be up to n processors listed. The following settings are displayed for each processor that is installed in the system: |

Table 41. Processor n details

| Option | Description |
|------------------------------|---|
| Family-Model-Stepping | Specifies the family, model, and stepping of the processor as defined by AMD. |
| Brand | Specifies the brand name. |
| Level 2 Cache | Specifies the total L2 cache. |
| Level 3 Cache | Specifies the total L3 cache. |
| Number of Cores | Specifies the number of cores per processor. |
| Microcode | Specifies the processor microcode version. |

SATA Settings

To view the **SATA Settings** screen, power on the system, press F2, and click **System Setup Main Menu > System BIOS > SATA Settings**.

Table 42. SATA Settings details

| Option | Description |
|----------------------|--|
| Embedded SATA | Enables the embedded SATA option to be set to Off , AHCI mode , or RAID modes . This option is set to AHCI Mode by default. i NOTE: <ol style="list-style-type: none"> 1. You might also need to change the Boot Mode setting to UEFI. Otherwise, you should set the field to Non-RAID mode. 2. No ESXi and Ubuntu OS support under RAID mode. |

Table 42. SATA Settings details (continued)

| Option | Description |
|-----------------------------|---|
| Security Freeze Lock | Sends Security Freeze Lock command to the embedded SATA drives during POST. This option is applicable only for AHCI Mode. This option is set to Enabled by default. |
| Write Cache | Enables or disables the command for the embedded SATA drives during POST. This option is set to Disabled by default. |

NVMe Settings

To view the **NVMe Settings** screen, power on the system, press F2, and click **System Setup Main Menu > System BIOS > NVMe Settings**

Table 43. NVMe Settings details

| Option | Description |
|-------------------------|--|
| NVMe Mode | This option sets the NVMe drive mode. If the system contains NVMe drives that you want to configure in a RAID array, you must set both this field and the Embedded SATA field on the SATA settings menu to RAID Mode. You may also need to change the Boot Mode setting to UEFI. The option is set to Non-RAID mode by default. |
| BIOS NVMe Driver | Dell Qualified NVMe drives always use the UEFI NVMe driver built into the Dell EROS. When this option is set to 'All Drives', the BIOS driver will also be used with any NVMe drives in the system that has not been qualified by Dell. The option is set to Dell Qualified Drives by default. <i>i</i> NOTE: When this option is set to 'All Drives' and non-Dell qualified NVMe drives are present, you have a configuration that has not been validated which may lead to unexpected behavior. |

Boot Settings

You can use the **Boot Settings** screen to set the boot mode to either **BIOS** or **UEFI**. It also enables you to specify the boot order.

- **UEFI:** The Unified Extensible Firmware Interface (UEFI) is a new interface between operating systems and platform firmware. The interface consists of data tables with platform related information, boot and runtime service calls that are available to the operating system and its loader. The following benefits are available when the **Boot Mode** is set to **UEFI**:
 - Support for drive partitions larger than 2 TB.
 - Enhanced security (e.g., UEFI Secure Boot).
 - Faster boot time.

i **NOTE:** You must use only the UEFI boot mode in order to boot from NVMe drives.

- **BIOS:** The **BIOS Boot Mode** is the legacy boot mode. It is maintained for backward compatibility.

To view the **Boot Settings** screen, power on the system, press F2, and click **System Setup Main Menu > System BIOS > Boot Settings**.

Table 44. Boot Settings details

| Option | Description |
|------------------|---|
| Boot Mode | Enables you to set the boot mode of the system. If the operating system supports UEFI, you can set this option to UEFI. Setting this field to BIOS allows compatibility with non-UEFI operating systems. This option is set to UEFI by default. <i>Δ</i> CAUTION: Switching the boot mode may prevent the system from booting if the operating system is not installed in the same boot mode. <i>i</i> NOTE: Setting this field to UEFI disables the BIOS Boot Settings menu. |

Table 44. Boot Settings details (continued)

| Option | Description | | | | | | |
|--|--|--------|-------------|---------------------------|--|-----------------------------------|--|
| Boot Sequence Retry | Enables or disables the Boot Sequence Retry feature. If this option is set to Enabled and the system fails to boot, the system re-attempts the boot sequence after 30 seconds. This option is set to Enabled by default. | | | | | | |
| Hard Disk Failover | Enables or disables the Hard-disk failover. This option is set to Disabled by default. | | | | | | |
| Generic USB Boot | Enables or disables the generic USB boot placeholder. This option is set to Disabled by default. | | | | | | |
| Hard-disk Drive Placeholder | Enables or disables the Hard-disk drive placeholder. This option is set to Disabled by default. | | | | | | |
| Clean all SysPrep variables and order | When set to None , BIOS will do nothing. When set to Yes , BIOS will delete variables of SysPrep #### and SysPrepOrder this option is a onetime option, will reset to none when deleting variables. This setting is only available in UEFI Boot Mode . This option is set to None by default. | | | | | | |
| UEFI Boot Settings | <p>Specifies the UEFI boot sequence. Enables or disables UEFI Boot options.</p> <p> NOTE: This option controls the UEFI boot order. The first option in the list will be attempted first.</p> <p>Table 45. UEFI Boot Settings</p> <table border="1"> <thead> <tr> <th>Option</th> <th>Description</th> </tr> </thead> <tbody> <tr> <td>UEFI Boot Sequence</td> <td>Enables you to change the boot device order.</td> </tr> <tr> <td>Boot Option Enable/Disable</td> <td>Enables you to select the enabled or disabled boot devices</td> </tr> </tbody> </table> | Option | Description | UEFI Boot Sequence | Enables you to change the boot device order. | Boot Option Enable/Disable | Enables you to select the enabled or disabled boot devices |
| Option | Description | | | | | | |
| UEFI Boot Sequence | Enables you to change the boot device order. | | | | | | |
| Boot Option Enable/Disable | Enables you to select the enabled or disabled boot devices | | | | | | |

Choosing system boot mode

System Setup enables you to specify one of the following boot modes for installing your operating system:

- UEFI boot mode (the default), is an enhanced 64-bit boot interface. If you have configured your system to boot to UEFI mode, it replaces the system BIOS.
- From the **System Setup Main Menu**, click **Boot Settings**, and select **Boot Mode**.
 - Select the UEFI boot mode you want the system to boot into.
-  **CAUTION: Switching the boot mode may prevent the system from booting if the operating system is not installed in the same boot mode.**
- After the system boots in the specified boot mode, proceed to install your operating system from that mode.

 **NOTE:** Operating systems must be UEFI-compatible to be installed from the UEFI boot mode. DOS and 32-bit operating systems do not support UEFI and can only be installed from the BIOS boot mode.

 **NOTE:** For the latest information about supported operating systems, go to www.dell.com/ossupport.

Changing boot order

About this task

You may have to change the boot order if you want to boot from a USB key or an optical drive. The following instructions may vary if you have selected **BIOS** for **Boot Mode**.

 **NOTE:** Changing the drive boot sequence is only supported in BIOS boot mode.

Steps

- On the **System Setup Main Menu** screen, click **System BIOS > Boot Settings > UEFI Boot Settings > UEFI Boot Sequence**.

2. Use the arrow keys to select a boot device, and use the plus (+) and minus (-) sign keys to move the device down or up in the order.
3. Click **Exit**, and then click **Yes** to save the settings on exit.

 **NOTE:** You can also enable or disable boot order devices as needed.

Network Settings

To view the **Network Settings** screen, power on the system, press F2, and click **System Setup Main Menu > System BIOS > Network Settings**.

 **NOTE:** For information about Linux network performance settings, see the *Linux Network Tuning Guide for AMD EPYC Processor Based Servers* at [AMD.com](https://www.amd.com).

 **NOTE:** Network Settings are not supported in BIOS boot mode.

Table 46. Network Settings details

| Option | Description |
|--|--|
| UEFI PXE Settings | Enables you to control the configuration of the UEFI PXE device. |
| Number of PXE Devices | Enables you to choose the number of PXE Devices from 1 to 4, 8, 12, 16. |
| PXE Device n (n = 1 to 16) | Enables or disables the device. When enabled, a UEFI PXE boot option is created for the device. |
| PXE Device n Settings (n = 1 to 16) | Enables you to control the configuration of the PXE device. |
| UEFI HTTP Settings | Enables you to control the configuration of the UEFI HTTP device. |
| HTTP Device n (n = 1 to 4) | Enables or disables the device. When enabled, a UEFI HTTP boot option is created for the device. |
| HTTP Device n Settings (n = 1 to 4) | Enables you to control the configuration of the HTTP device. |
| UEFI ISCSI Settings | Enables you to control the configuration of the ISCSI device. |
| UEFI NVMe-oF Settings | Enables you to control the configuration of the NVMe-oF device. |

Table 47. PXE Device n Settings details

| Option | Description |
|----------------------|--|
| Interface | Specifies NIC interface used for the PXE device. |
| Protocol | Specifies Protocol used for PXE device. This option is set to IPv4 or IPv6 . This option is set to IPv4 by default. |
| VLAN | Enables VLAN for PXE device. This option is set to Enable or Disable . This option is set to Disable by default. |
| VLAN ID | Shows the VLAN ID for the PXE device |
| VLAN Priority | Shows the VLAN Priority for the PXE device. |

Table 48. HTTP Device n Settings details

| Option | Description |
|------------------|---|
| Interface | Specifies NIC interface used for the HTTP device. |
| Protocol | Specifies Protocol used for HTTP device. This option is set to IPv4 or IPv6 . This option is set to IPv4 by default. The following options will be available when Protocol is set as IPv6: Auto Configuration: IPv6 Auto Configuration Enable/Disabled for this HTTP Device. IPv6 Address: IPv6 Unicast address for this HTTP Device. |

Table 48. HTTP Device n Settings details (continued)

| Option | Description |
|--|--|
| | Prefix Length: IPv6 Prefix Length (0-128) for this HTTP Device. |
| VLAN | Enables VLAN for HTTP device. This option is set to Enable or Disable . This option is set to Disable by default. |
| VLAN ID | Shows the VLAN ID for the HTTP device |
| VLAN Priority | Shows the VLAN Priority for the HTTP device. |
| DHCP | Enables or disables DHCP for this HTTP device. This option is set to Enable by default. |
| IP Address | Specifies IP address for the HTTP device. |
| Subnet Mask | Specifies subnet mask for the HTTP device. |
| Gateway | Specifies gateway for the HTTP device. |
| DNS info via DHCP | Enables or disables DNS Information from DHCP. This option is set to Enable by default. |
| Primary DNS | Specifies the primary DNS server IP address for the HTTP Device. |
| Secondary DNS | Specifies the secondary DNS server IP address for the HTTP Device. |
| URI (will obtain from DHCP server if not specified) | The URI will be obtained from the DHCP server if not specified. |
| TLS Authentication Configuration | View and/or modify this device's boot TLS authentication configuration. |

Table 49. UEFI ISCSI Settings screen details

| Option | Description |
|-------------------------------|---|
| ISCSI Initiator Name | Specifies the name of the ISCSI initiator in IQN format. |
| ISCSI Device1 | Enables or disables the ISCSI device. When disabled, a UEFI boot option is created for the ISCSI device automatically. This is set to Disabled by default. |
| ISCSI Device1 Settings | Enables you to control the configuration of the ISCSI device. |

Table 50. ISCSI Device1 Settings screen details

| Option | Description |
|------------------------------|--|
| Connection 1 | Enables or disables the ISCSI connection. This option is set to Disable by default. |
| Connection 2 | Enables or disables the ISCSI connection. This option is set to Disable by default. |
| Connection 1 Settings | Enables you to control the configuration for the ISCSI connection. |
| Connection 2 Settings | Enables you to control the configuration for the ISCSI connection. |
| Connection Order | Enables you to control the order for which the ISCSI connections will be attempted. |

Table 51. UEFI NVMe-oF Settings screen details

| Option | Description |
|-----------------------------------|---|
| NVMe-oF | Enables or disables the NVMe-oF device. When disabled, a UEFI boot option is created for the NVMe-oF device automatically. This is set to Disabled by default. |
| NVMe-oF Host NQN | Specifies Host NQN of the NVMe-oF device. |
| NVMe-oF Host Id | Specifies Host Id of the NVMe-oF device. |
| Host Security Key Path | Specifies Host Security Key Path of the NVMe-oF device. |
| NVMe-oF SubSystem Settings | Enables you to control the configuration of the NVMe-oF device. |

Integrated Devices

To view the **Integrated Devices** screen, power on the system, press F2, and click **System Setup Main Menu > System BIOS > Integrated Devices**.

Table 52. Integrated Devices details

| Option | Description |
|---|---|
| User Accessible USB Ports | <p>Configures the user accessible USB ports. Selecting Only Back Ports On disables the front USB ports; selecting All Ports Off disables all front and back USB ports; selecting All Ports Off (Dynamic) disables all front and back USB ports during POST. This option is set to All Ports On by default. When user accessible USB ports is set to All Ports Off (Dynamic) the Enable Front Ports Only option is enabled.</p> <ul style="list-style-type: none"> • Enable Front Ports Only: Enables or disables the front USB ports during the OS runtime. <p>The USB keyboard and mouse still function in certain USB ports during the boot process, depending on the selection. After the boot process is complete, the USB ports will be enabled or disabled as per the setting.</p> |
| Internal USB Port | <p>Enables or disables the Internal USB Port. This option is set to On or Off. This option is set to On by default.</p> |
| iDRAC Direct USB Port | <p>The iDRAC Direct USB port is managed by iDRAC exclusively with no host visibility. This option is set to ON or OFF. When set to OFF, iDRAC does not detect any USB devices installed in this managed port. This option is set to On by default. Enables or disables the integrated RAID controller. When set to Disabled, the device is not visible to the operating system(OS). Enables or disables the integrated RAID controller. When set to Disabled, the device is not visible to the operating system(OS).</p> |
| Integrated RAID Controller | <p>Enables or disables the integrated RAID controller. When set to Disabled, the device is not visible to the operating system(OS).</p> |
| Embedded NIC1 and NIC2 | <p>Enables or disables the Embedded NIC1 and NIC2 options. If set to Disabled (OS), the NIC may still be available for shared network access by the embedded management controller. Configure the Embedded NIC1 and NIC2 option by using the NIC management utilities of the system.</p> |
| Embedded Video Controller | <p>Enables or disables the use of Embedded Video Controller as the primary display. When set to Enabled, the Embedded Video Controller will be the primary display even if add-in graphic cards are installed. When set to Disabled, an add-in graphics card will be used as the primary display. BIOS will output displays to both the primary add-in video and the embedded video during POST and pre-boot environment. The embedded video will then be disabled right before the operating system boots. This option is set to Enabled by default.</p> <p>i NOTE: When there are multiple add-in graphic cards installed in the system, the first card discovered during PCI enumeration is selected as the primary video. You might have to re-arrange the cards in the slots in order to control which card is the primary video.</p> |
| Current State of Embedded Video Controller | <p>Displays the current state of the embedded video controller. The Current State of Embedded Video Controller option is a read-only field. If the Embedded Video Controller is the only display capability in the system (that is, no add-in graphics card is installed), then the Embedded Video Controller is automatically used as the primary display even if the Embedded Video Controller setting is set to Disabled.</p> |
| SR-IOV Global Enable | <p>Enables or disables the BIOS configuration of Single Root I/O Virtualization (SR-IOV) devices. This option is set to Disabled by default.</p> |
| OS Watchdog Timer | <p>If your system stops responding, this watchdog timer aids in the recovery of your operating system. When this option is set to Enabled, the operating</p> |

Table 52. Integrated Devices details (continued)

| Option | Description |
|--------------------------------|---|
| | system initializes the timer. When this option is set to Disabled (the default), the timer does not have any effect on the system. |
| Memory Mapped I/O Limit | Controls where MMIO is mapped. The 1 TB option is designed for specific OS which cannot support MMIO over 1 TB. This option is set to 8 TB by default. The default option is the maximum address that the system supports and recommended in most cases. |
| Slot Disablement | Enables or disables the available PCIe slots on your system. The slot disablement feature controls the configuration of the PCIe cards installed in the specified slot. Slots must be disabled only when the installed peripheral card prevents booting into the operating system or causes delays in system startup. If the slot is disabled, both the Option ROM and UEFI drivers are disabled. Only slots that are present on the system will be available for control. Slot n: Enables or disables or only the boot driver is disabled for the PCIe slot n. This option is set to Enabled by default. |
| Slot Bifurcation | Slot Discovery Bifurcation Settings allows Platform Default Bifurcation and Manual bifurcation Control . The default is set to Platform Default Bifurcation . The slot bifurcation field is accessible when set to Manual bifurcation Control and is grayed out when set to Platform Default Bifurcation .  NOTE: This option is only available for 3rd Generation AMD EPYC processors. |

Serial Communication

To view the **Serial Communication** screen, power on the system, press F2, and click **System Setup Main Menu > System BIOS > Serial Communication**.

Table 53. Serial Communication details





| Option | Description |
|----------------------------------|---|
| Serial Communication | Selects serial communication devices (Serial Device 1 and Serial Device 2) in BIOS. BIOS console redirection can also be enabled and the port address can be specified. This option is set to Auto by default. |
| Serial Port Address | Enables you to set the port address for serial devices.  NOTE: You can use only Serial Device 2 for the Serial Over LAN (SOL) feature. To use console redirection by SOL, configure the same port address for console redirection and the serial device.  NOTE: Every time the system boots, the BIOS syncs the serial MUX setting that is saved in iDRAC. The serial MUX setting can independently be changed in iDRAC. Loading the BIOS default settings from within the BIOS setup utility may not always revert the serial MUX setting to the default setting of Serial Device 1. |
| External Serial Connector | Enables you to associate the External Serial Connector to Serial Device 1 , Serial Device 2 , or the Remote Access Device by using this option. This option is set to Serial Device 1 by default.  NOTE: Only Serial Device 2 can be used for Serial Over LAN (SOL). To use console redirection by SOL, configure the same port address for console redirection and the serial device.  NOTE: Every time the system boots, the BIOS syncs the serial MUX setting saved in iDRAC. The serial MUX setting can independently be changed in iDRAC. Loading the BIOS default settings from within the BIOS |

Table 53. Serial Communication details (continued)

| Option | Description |
|-------------------------------|---|
| | setup utility may not always revert this setting to the default setting of Serial Device 1. |
| Failsafe Baud Rate | Specifies the failsafe baud rate for console redirection. The BIOS attempts to determine the baud rate automatically. This failsafe baud rate is used only if the attempt fails, and the value must not be changed. This option is set to 115200 by default. |
| Remote Terminal Type | Sets the remote console terminal type. This option is set to VT100/VT220 by default. |
| Redirection After Boot | Enables or disables the BIOS console redirection when the operating system is loaded. This option is set to Enabled by default. |

System Profile Settings

To view the **System Profile Settings** screen, power on the system, press F2, and click **System Setup Main Menu > System BIOS > System Profile Settings**.

Table 54. System Profile Settings details

| Option | Description |
|--|---|
| System Profile | Sets the system profile. If you set the System Profile option to a mode other than Custom , the BIOS automatically sets the rest of the options. You can only change the rest of the options if the mode is set to Custom . This option is set to Performance Per Watt (OS) by default. Other options include Performance and Custom . i NOTE: All the parameters on the system profile setting screen are available only when the System Profile option is set to Custom . |
| CPU Power Management | Sets the CPU power management. This option is set to OS DBPM by default. Other option includes Maximum Performance . |
| Memory Frequency | Sets the speed of the system memory. You can select Maximum Performance or a specific speed. This option is set to Maximum Performance by default. |
| Turbo Boost | Enables or disables the processor to operate in the turbo boost mode. This option is set to Enabled by default. |
| C-States | Enables or disables the processor to operate in all available power states. C States allow the processor to enter lower power states when idle. When set to Enabled (OS controlled) or when set to Autonomous (if hardware controlled is supported), the processor can operate in all available Power States to save power, but may increase memory latency and frequency jitter. This option is set to Enabled by default. |
| Write Data CRC | When set to Enabled , DDR4 data bus issues are detected and corrected during 'write' operations. Two extra cycles are required for CRC bit generation which impacts the performance. Read-only unless System Profile is set to Custom . This option is set to Disabled by default. |
| Memory Patrol Scrub | Sets the memory patrol scrub mode. This option is set to Standard by default. |
| Memory Refresh Rate | Sets the memory refresh rate to either 1x or 2x. This option is set to 1x by default. |
| Workload Profile | Allows optimization of performance based on the workload type. The Workload Profile setting is not a state . Setting a Workload Profile is a one-time action that in turns modifies various BIOS settings to be optimized for the requested workload type. This option is set to Not Configured by default. |
| PCI ASPM L1 Link Power Management | Enables or disables the PCI ASPM L1 Link Power Management. This option is set to Enabled by default. |
| Determinism Slider | Set the system determinism by Power Determinism or Performance Determinism . This option is set to Performance Determinism by default. |

Table 54. System Profile Settings details (continued)

| Option | Description |
|---|---|
| Power Profile Select | High performance Mode(default): Favors core performance. All DF P-States are available in this mode and the default DF P-State and DLWM algorithms are active. Efficiency Mode: Configures the system for power efficiency. Limits boost frequency available to cores and restricts DF P-States available in the system. Maximum IO Performance Mode: Sets up Date Fabric to maximize IO sub-system performance. |
| PCIE Speed PMM Control | Reduce link speed when devices are idle. This option is set to Auto by default. |
| EQ Bypass To Highest Rate | Controls the ability to advertise Equalization Bypass to Highest Rate Support in TSxs sent prior to LinkUp=1r. This option is set to Disabled by default. |
| DF PState Frequency Optimizer | Disabled: Disabled the DP P-state CCLK effective frequency optimizer. Enabled: Enables the DP P-state CCLK effective frequency optimizer. This option is set to Enabled by default. |
| DF PState Latency Optimizer | Disabled: Disables the DP P-state latency optimizer. Enabled: Enables the DF P-state latency optimizer. This option is set to Enabled by default. |
| DF CState | This field enables(0xF)/disables(0x0) DF Cstate. This option is set to Enabled by default. |
| Host System Management Port(HSMP)Support | This value controls Host System Management Port(HSMP) interface to provide OS-level software with access to system management functions via a set of mail box registers. This option is set to Enabled by default. |
| Boost FMax | Boost Fmax. This option is set to 0 - Auto by default. |
| Algorithm Performance Boost Disable (ApbDis) | Enables or disables the Algorithm Performance Boost Disable (ApbDis). This option is set to Disabled by default. |

System Security

To view the **System Security** screen, power on the system, press F2, and click **System Setup Main Menu > System BIOS > System Security**.

Table 55. System Security details

| Option | Description |
|------------------------|---|
| CPU AES-NI | Improves the speed of applications by performing encryption and decryption by using the Advanced Encryption Standard Instruction Set (AES-NI). This option is set to Enabled by default. |
| System Password | Sets the system password. This option is set to Enabled by default and is read-only if the password jumper is not installed in the system. |
| Setup Password | Sets the setup password. This option is read-only if the password jumper is not installed in the system. |
| Password Status | Locks the system password. This option is set to Unlocked by default. |

Table 56. System Security details (continued)

| Option | Description |
|------------------------|---|
| TPM Security | This field controls the reporting of the Trusted Platform Module(TPM) in the system. When set to Off, the presence of the TPM is not reported to the OS. When set to Off, the presence of the TPM is not reported to the OS. When set to On, the presence of the TPM is reported to the OS. |
| TPM Information | Indicates the type of Trusted Platform Module, if present. |
| TPM Firmware | Indicates the firmware version of a Trusted Platform Module(TPM). |
| TPM Heirachy | Allows enabling, disabling or clearing the storage and endorsement hierarchies. |

Table 56. System Security details (continued)

| Option | Description |
|---|---|
| | <p>When set to Enabled, the storage and endorsement hierarchies can be used. When set to Disabled, the storage and endorsement hierarchies cannot be used. When set to Clear, the storage and endorsement hierarchies are cleared of any values and then reset to Enabled.</p> |
| <p>TPM Advanced Settings</p> | <p>TPM PPI Bypass Provision When set to Enabled, allows the Operating System to bypass Physical Presence Interface(PPI) prompts when issuing PPI Advanced Configuration and Power Interface (ACPI) provisioning operations.</p> <p>TPM PPI Bypass Clear When set to Enabled, allows the Operating System to bypass Physical Presence Interface(PPI) prompts when issuing PPI Advanced Configuration and Power Interface (ACPI) clear operations.</p> <p>TPM2 Algorithm Selection Allows the user to change the cryptographic algorithms used in the Trusted Platform Module (TPM). The available options are dependant on the TPM firmware.</p> <p>To enable TPM2 Algorithm Selection, Intel(R) TXT technology must be disabled.</p> |
| <p>AMD DRTM</p> | <p>Enable/Disable AMD Dynamic Root of Trust Measurement (DRTM)</p> <p>To enable AMD DRTM, below configurations must be enabled:</p> <ol style="list-style-type: none"> 1. TPM2.0 must be enabled and the hash algorithm must be set to SHA256. 2. Transparent SME (TSME) must be enabled. |
| <p>Power Button</p> | <p>Enables or disables the power button on the front of the system. This option is set to Enabled by default.</p> |
| <p>AC Power Recovery</p> | <p>Sets how the system behaves after AC power is restored to the system. This option is set to Last by default.</p> |
| <p>AC Power Recovery Delay</p> | <p>Sets the time delay for the system to power up after AC power is restored to the system. This option is set to Immediate by default.</p> |
| <p>User Defined Delay (120s to 600s)</p> | <p>Controls the duration for which the power-on process is delayed after the AC power supply is restored. The value is only effective if AC Power Recovery Delay is set to User Defined. The valid range is between 120s and 600s.</p> |
| <p>UEFI Variable Access</p> | <p>Provides varying degrees of securing UEFI variables. When set to Standard (the default), UEFI variables are accessible in the operating system per the UEFI specification. When set to Controlled, selected UEFI variables are protected in the environment and new UEFI boot entries are forced to be at the end of the current boot order.</p> |
| <p>SMM Security Mitigation</p> | <p>This option enables or disables additional UEFI SMM Security Mitigation protections. This option is available only in UEFI boot mode. The operating system can use this feature to help protect the secure environment created by virtualization based security. Enabling this feature provides additional UEFI SMM Security Mitigation protections. However, this feature may cause compatibility issue or loss of functionality with some legacy tools or applications.</p> |
| <p>Secure Boot</p> | <p>Enables Secure Boot, where the BIOS authenticates each pre-boot image by using the certificates in the Secure Boot Policy. Secure Boot is set to Disabled by default.</p> |
| <p>Secure Boot Policy</p> | <p>When Secure Boot policy is set to Standard, the BIOS uses the system manufacturer's key and certificates to authenticate pre-boot images. When Secure Boot policy is set to Custom, the BIOS uses the user-defined key and certificates. Secure Boot policy is set to Standard by default.</p> |
| <p>Secure Boot Mode</p> | <p>Configures how the BIOS uses the Secure Boot Policy Objects (PK, KEK, db, dbx). If the current mode is set to Deployed Mode, the available options are User Mode and Deployed Mode.</p> |

Table 56. System Security details (continued)

| Option | Description | | | | | | | | |
|---|--|---------|--------------|------------------|---|----------------------|--|-------------------|---|
| | <p>If the current mode is set to User Mode, the available options are User Mode, Audit Mode, and Deployed Mode.</p> <table border="1" data-bbox="798 291 1492 1019"> <caption>Table 57. Secure Boot Mode</caption> <thead> <tr> <th>Options</th> <th>Descriptions</th> </tr> </thead> <tbody> <tr> <td>User Mode</td> <td>In User Mode, PK must be installed, and BIOS performs signature verification on programmatic attempts to update policy objects. The BIOS allows unauthenticated programmatic transitions between modes.</td> </tr> <tr> <td>Deployed Mode</td> <td>Deployed Mode is the most secure mode. In Deployed Mode, PK must be installed and the BIOS performs signature verification on programmatic attempts to update policy objects. Deployed Mode restricts the programmatic mode transitions.</td> </tr> <tr> <td>Audit Mode</td> <td>In Audit mode, PK is not present. The BIOS does not authenticate programmatic updates to the policy objects, and transitions between modes. The BIOS performs a signature verification on pre-boot images and logs the results in the image Execution Information Table, but executes the images whether they pass or fail verification. Audit Mode is useful for programmatic determination of a working set of policy objects.</td> </tr> </tbody> </table> | Options | Descriptions | User Mode | In User Mode , PK must be installed, and BIOS performs signature verification on programmatic attempts to update policy objects. The BIOS allows unauthenticated programmatic transitions between modes. | Deployed Mode | Deployed Mode is the most secure mode. In Deployed Mode , PK must be installed and the BIOS performs signature verification on programmatic attempts to update policy objects. Deployed Mode restricts the programmatic mode transitions. | Audit Mode | In Audit mode , PK is not present. The BIOS does not authenticate programmatic updates to the policy objects, and transitions between modes. The BIOS performs a signature verification on pre-boot images and logs the results in the image Execution Information Table, but executes the images whether they pass or fail verification. Audit Mode is useful for programmatic determination of a working set of policy objects. |
| Options | Descriptions | | | | | | | | |
| User Mode | In User Mode , PK must be installed, and BIOS performs signature verification on programmatic attempts to update policy objects. The BIOS allows unauthenticated programmatic transitions between modes. | | | | | | | | |
| Deployed Mode | Deployed Mode is the most secure mode. In Deployed Mode , PK must be installed and the BIOS performs signature verification on programmatic attempts to update policy objects. Deployed Mode restricts the programmatic mode transitions. | | | | | | | | |
| Audit Mode | In Audit mode , PK is not present. The BIOS does not authenticate programmatic updates to the policy objects, and transitions between modes. The BIOS performs a signature verification on pre-boot images and logs the results in the image Execution Information Table, but executes the images whether they pass or fail verification. Audit Mode is useful for programmatic determination of a working set of policy objects. | | | | | | | | |
| Secure Boot Policy Summary | Specifies the list of certificates and hashes that secure boot uses to authenticate images. | | | | | | | | |
| Secure Boot Custom Policy Settings | Configures the Secure Boot Custom Policy. To enable this option, set the Secure Boot Policy to Custom option. | | | | | | | | |

Creating a system and setup password

Prerequisites

Ensure that the password jumper is enabled. The password jumper enables or disables the system password and setup password features. For more information, see the System board jumper settings section.

i **NOTE:** If the password jumper setting is disabled, the existing system password and setup password are deleted and you need not provide the system password to boot the system.

Steps

- To enter System Setup, press F2 immediately after turning on or rebooting your system.
- On the **System Setup Main Menu** screen, click **System BIOS > System Security**.
- On the **System Security** screen, verify that **Password Status** is set to **Unlocked**.
- In the **System Password** field, type your system password, and press Enter or Tab.
Use the following guidelines to assign the system password:
 - A password can have up to 32 characters.
 A message prompts you to reenter the system password.
- Reenter the system password, and click **OK**.
- In the **Setup Password** field, type your setup password and press Enter or Tab.
A message prompts you to reenter the setup password.
- Reenter the setup password, and click **OK**.
- Press Esc to return to the System BIOS screen. Press Esc again.
A message prompts you to save the changes.

 **NOTE:** Password protection does not take effect until the system reboots.

Using your system password to secure your system

About this task

If you have assigned a setup password, the system accepts your setup password as an alternate system password.

Steps

1. Turn on or reboot your system.
2. Type the system password and press Enter.

Next steps

When **Password Status** is set to **Locked**, type the system password and press Enter when prompted at reboot.

 **NOTE:** If an incorrect system password is typed, the system displays a message and prompts you to reenter your password. You have three attempts to type the correct password. After the third unsuccessful attempt, the system displays an error message that the system has stopped functioning and must be turned off. Even after you turn off and restart the system, the error message is displayed until the correct password is entered.

Deleting or changing system and setup password

Prerequisites

 **NOTE:** You cannot delete or change an existing system or setup password if the **Password Status** is set to **Locked**.

Steps

1. To enter System Setup, press F2 immediately after turning on or restarting your system.
2. On the **System Setup Main Menu** screen, click **System BIOS > System Security**.
3. On the **System Security** screen, ensure that **Password Status** is set to **Unlocked**.
4. In the **System Password** field, alter or delete the existing system password, and then press Enter or Tab.
5. In the **Setup Password** field, alter or delete the existing setup password, and then press Enter or Tab.
If you change the system and setup password, a message prompts you to reenter the new password. If you delete the system and setup password, a message prompts you to confirm the deletion.
6. Press Esc to return to the **System BIOS** screen. Press Esc again, and a message prompts you to save the changes.
7. Select **Setup Password**, change, or delete the existing setup password and press Enter or Tab.

 **NOTE:** If you change the system password or setup password, a message prompts you to reenter the new password. If you delete the system password or setup password, a message prompts you to confirm the deletion.

Operating with setup password enabled

If **Setup Password** is set to **Enabled**, type the correct setup password before modifying the system setup options.

If you do not type the correct password in three attempts, the system displays the following message:

```
Invalid Password! Number of unsuccessful password attempts: <x> System Halted! Must power down.
```

```
Password Invalid. Number of unsuccessful password attempts: <x> Maximum number of password attempts exceeded. System halted.
```

Even after you turn off and restart the system, the error message is displayed until the correct password is typed. The following options are exceptions:

- If **System Password** is not set to **Enabled** and is not locked through the **Password Status** option, you can assign a system password. For more information, see the System Security Settings screen section.
- You cannot disable or change an existing system password.

i **NOTE:** You can use the password status option with the setup password option to protect the system password from unauthorized changes.

Redundant OS Control

To view the **Redundant OS Control** screen, power on the system, press F2, and click **System Setup Main Menu > System BIOS > Redundant OS Control**.

Table 58. Redundant OS Control details

| Option | Description |
|------------------------------|--|
| Redundant OS Location | Enables you to select a backup disk from the following device: <ul style="list-style-type: none"> • None • BOSS PCIe Cards (Internal M.2 Drives) |
| Redundant OS State | <p>i NOTE: This option is disabled if Redundant OS Location is set to None.</p> <p>When set to Visible, the backup disk is visible to the boot list and OS. When set to Hidden, the backup disk is disabled and is not visible to the boot list and OS. This option is set to Visible by default.</p> <p>i NOTE: BIOS disables the device in hardware, so it is not accessed by the OS.</p> |
| Redundant OS Boot | <p>i NOTE: This option is disabled if Redundant OS Location is set to None or if Redundant OS State is set to Hidden.</p> <p>When set to Enabled, BIOS boots to the device specified in Redundant OS Location. When set to Disabled, BIOS preserves the current boot list settings. This option is set to Enabled by default.</p> |

Miscellaneous Settings

To view the **Miscellaneous Settings** screen, power on the system, press F2, and click **System Setup Main Menu > System BIOS > Miscellaneous Settings**.

Table 59. Miscellaneous Settings details

| Option | Description |
|-------------------------------------|--|
| System Time | Enables you to set the time on the system. |
| System Date | Enables you to set the date on the system. |
| Time Zone | Times offset from UTC. |
| Daylight Savings Time | Enables or disables the Daylight Savings Time option. This option is set to Disabled by default. |
| Asset Tag | Specifies the asset tag and enables you to modify it for security and tracking purposes. |
| Keyboard NumLock | Enables you to set whether the system boots with the NumLock enabled or disabled. This option is set to On by default. i NOTE: This option does not apply to 84-key keyboards. |
| F1/F2 Prompt on Error | Enables or disables the F1/F2 prompt on error. This option is set to Enabled by default. The F1/F2 prompt also includes keyboard errors. |
| Load Legacy Video Option ROM | Enables or disables the Load Legacy Video Option ROM option. This option is set to Disabled by default. |

Table 59. Miscellaneous Settings details (continued)

| Option | Description |
|--------------------------------------|---|
| Dell Wyse P25/P45 BIOS Access | Enables or disables the Dell Wyse P25/P45 BIOS Access. This option is set to Enabled by default. |
| Power Cycle Request | Enables or disables the Power Cycle Request. This option is set to None by default. |

iDRAC Settings utility

The iDRAC settings utility is an interface to set up and configure the iDRAC parameters by using UEFI. You can enable or disable various iDRAC parameters by using the iDRAC settings utility.

 **NOTE:** Accessing some of the features on the iDRAC settings utility needs the iDRAC Enterprise License upgrade.

For more information about using iDRAC, see *Dell Integrated Dell Remote Access Controller User's Guide* at <https://www.dell.com/idracmanuals>.

Device Settings

Device Settings enables you to configure device parameters such as storage controllers or network cards.

Dell Lifecycle Controller

Dell Lifecycle Controller (LC) provides advanced embedded systems management capabilities including system deployment, configuration, update, maintenance, and diagnosis. LC is delivered as part of the iDRAC out-of-band solution and Dell system embedded Unified Extensible Firmware Interface (UEFI) applications.

Embedded system management

The Dell Lifecycle Controller provides advanced embedded system management throughout the lifecycle of the system. The Dell Lifecycle Controller is started during the boot sequence and functions independently of the operating system.

 **NOTE:** Certain platform configurations may not support the full set of features provided by the Dell Lifecycle Controller.

For more information about setting up the Dell Lifecycle Controller, configuring hardware and firmware, and deploying the operating system, see the Dell Lifecycle Controller documentation at <https://www.dell.com/idracmanuals>.

Boot Manager

The **Boot Manager** option enables you to select boot options and diagnostic utilities.

To enter **Boot Manager**, power on the system and press F11.

Table 60. Boot Manager details

| Option | Description |
|------------------------------------|---|
| Continue Normal Boot | The system attempts to boot to devices starting with the first item in the boot order. If the boot attempt fails, the system continues with the next item in the boot order until the boot is successful or no more boot options are found. |
| One-shot UEFI Boot Menu | Enables you to access boot menu, where you can select a one-time boot device to boot from. |
| Launch System Setup | Enables you to access System Setup. |
| Launch Lifecycle Controller | Exits the Boot Manager and invokes the Dell Lifecycle Controller program. |

Table 60. Boot Manager details (continued)

| Option | Description |
|-------------------------|---|
| System Utilities | Enables you to launch System Utilities menu such as Launch Diagnostics, BIOS update File Explorer, Reboot System. |

PXE boot

You can use the Preboot Execution Environment (PXE) option to boot and configure the networked systems remotely.

To access the **PXE boot** option, boot the system and then press F12 during POST instead of using standard Boot Sequence from BIOS Setup. It does not pull any menu or allows managing of network devices.

Minimum to POST and system management configuration validation

This section describes the minimum to POST system requirement and system management configuration validation of the Dell system.

Topics:

- [Minimum configuration to POST](#)
- [Configuration validation](#)

Minimum configuration to POST

The components listed below are the minimum configuration to POST:

- One processor in processor socket 1
- One memory modules (DIMM) in slot A1
- One power supply unit
- System board + LOM + RIO card

Configuration validation

The new generation of Dell systems have added interconnect flexibility and advanced iDRAC management features to collect precise system configuration information and report configuration errors.

When the system is powered on, information about installed cables, risers, backplanes, power supplies, floating card (fPERC, BOSS), and processor is obtained from the CPLD and backplane memory maps are analyzed. This information forms a unique configuration, which is compared with one of the qualified configurations that are stored in a table maintained by iDRAC.

One or more sensors are assigned to each of the configuration elements. During POST, any configuration validation error is logged in the System Event Log (SEL)/LifeCycle (LC) log. The reported events are categorized in the configuration validation error table.

Table 61. Configuration validation error

| Error | Description | Possible cause and recommendations | Example |
|----------------|---|--|---|
| Config Error | A configuration element within the closest match contains something that is unexpected and does not match any Dell qualified configuration. | Wrong configuration | Config Error: Backplane cable CTRS_SRC_SA1 and BP-DST_SA1 |
| | | The element reported in HWC8010 errors are assembled incorrectly. Verify element (cable, risers, etc) placement in the system. | Config Error : SL Cable PLANAR_SL7 and CTRL_DST_PA1 |
| Config Missing | iDRAC found a configuration element missing within the closest match detected. | Missing or damaged cable, device, or part | Config Missing: Float card front PERC/HBAadapter PERC/HBA |
| | | Missing element or cable is reported in HWC8010 error logs. Install the missing element (cable, risers, etc). | Config Missing : SL cable PLANAR_SL8 and CTRL_DST_PA1 |

Table 61. Configuration validation error (continued)

| Error | Description | Possible cause and recommendations | Example |
|------------|---|--|-------------------------|
| Comm Error | A configuration element is not responding to iDRAC using the management interface while running an inventory check. | System management sideband communication Unplug AC Power, reseal the element and replace the element if the problem persists. | Comm Error: Backplane 2 |

Error messages

This section describes the error messages displayed on the screen during POST or captured in the system event log (SEL)/ LifeCycle (LC) log.

Table 62. Error message HWC8010

| Error code | HWC8010 |
|-----------------------------|---|
| Message | The System Configuration Check operation resulted in the following issue involving the indicated component type |
| Arguments | Riser, floating card (fPERClike BOSS), backplane, processor, cable, or other components |
| Detailed Description | The issue identified in the message is observed in the System Configuration Check operation. |
| Recommended Response Action | Do the following and retry the operation: <ol style="list-style-type: none"> 1. Disconnect the input power. 2. Check for proper cable connection and component placement. If the issue persists, contact the service provider. |
| Category | System Health (HWC = Hardware Config) |
| Severity | Critical |
| Trap/EventID | 2329 |

Table 63. Error message HWC8011

| Error code | HWC8011 |
|-----------------------------|---|
| Message | The System Configuration Check operation resulted in multiple issues involving the indicated component type |
| Arguments | Riser, floating card (fPERClike BOSS), backplane, processor, cable, or other components |
| Detailed Description | Multiple issues are observed in the System Configuration Check operation. |
| Recommended Response Action | Do the following and retry the operation: <ol style="list-style-type: none"> 1. Disconnect the input power. 2. Check for proper cable connection and component placement. If the issue persists, contact the service provider. |
| Category | System Health (HWC = Hardware Config) |
| Severity | Critical |

Installing and removing system components

Topics:

- Safety instructions
- Before working inside your system
- After working inside your system
- Recommended tools
- Optional front bezel
- System cover
- Drive backplane cover
- Air shroud
- Cooling fan
- Drives
- Rear drive module
- Drive backplane
- Side wall brackets
- Cable routings
- PERC module
- System memory
- Processor and heat sink
- Expansion cards and expansion card risers
- Optional serial COM port
- VGA module
- M.2 SSD module
- Optional BOSS-N1 module
- System battery
- Optional internal USB card
- Intrusion switch module
- Optional OCP card
- Control panel
- Power supply unit
- Trusted Platform Module
- System board
- LOM card and rear I/O board

Safety instructions

 **NOTE:** To avoid injury, do not lift the system on your own. Get others to assist you.

 **WARNING:** Opening or removing the system cover while the system is turned on may expose you to a risk of electric shock..

 **CAUTION:** Many repairs may only be done by a certified service technician. You should only perform troubleshooting and simple repairs as authorized in your product documentation, or as directed by the online or telephone service and support team. Damage due to servicing that is not authorized by Dell is not covered by your warranty. Read and follow the safety instructions that are shipped with your product.

 **CAUTION:** To ensure proper operation and cooling, all system bays and fans must be always populated with a component or a blank.

- NOTE:** It is recommended that you always use an antistatic mat and antistatic strap while working on components inside the system.
- NOTE:** While replacing the hot swappable PSU, after next server boot; the new PSU automatically updates to the same firmware and configuration of the replaced one. For more information about the Part replacement configuration, see the *Lifecycle Controller User's Guide* at <https://www.dell.com/idracmanuals>
- NOTE:** While replacing faulty storage controller/FC/NIC card with the same type of card, after you power on the system; the new card automatically updates to the same firmware and configuration of the faulty one. For more information about the Part replacement configuration, see the *Lifecycle Controller User's Guide* at <https://www.dell.com/idracmanuals>
- NOTE:** For detailed information on cabling the cards, see the system-specific owner's manual at Installation and Service Manual available at <https://www.dell.com/poweredgemanuals>

Before working inside your system

Prerequisites

Follow the safety guidelines listed in [Safety instructions](#).

Steps

1. Power off the system and all attached peripherals.
2. Disconnect the system from the electrical outlet, and disconnect the peripherals.
3. If applicable, remove the system from the rack.
For more information, see the *Rail Installation Guide* relevant to your rail solutions at www.dell.com/poweredgemanuals.
4. Remove the system cover.

After working inside your system

Prerequisites

Follow the safety guidelines listed in [Safety instructions](#).

Steps

1. Replace the system cover.
2. If applicable, install the system into the rack.
For more information, see the *Rail Installation Guide* relevant to your rail solutions at www.dell.com/poweredgemanuals.
3. Reconnect the peripherals and connect the system to the electrical outlet, and then power on the system.

Recommended tools

You may need some or all of the following tools to perform the removal and installation procedures:

- Key to the bezel lock. The key is required only if your system includes a bezel.
- Phillips 1 screwdriver
- Phillips 2 screwdriver
- Torx T8 screwdriver
- Torx T6 screwdriver
- Torx T20 screwdriver
- 5 mm hex nut screwdriver
- Plastic scribe
- 1/4-inch flat blade screwdriver
- Wrist grounding strap connected to the ground
- ESD mat

- Needle-nose pliers

You need the following tools to assemble the cables for a DC power supply unit:

- AMP 90871-1 hand-crimping tool or equivalent
- Tyco Electronics 58433-3 or equivalent
- Wire-stripper pliers to remove insulation from size 10 AWG solid or stranded, insulated copper wire

i **NOTE:** Use alpha wire part number 3080 or equivalent (65/30 stranding).

i **NOTE:** For information about DC PSU cabling instructions, go to <https://www.dell.com/poweredgemanuals> > **Rack Servers** > PowerEdge R6615 > **Select This Product** > **Documentation** > **Manuals and Documents** > *Cabling instructions for – 48 – 60 V DC power supply.*

Optional front bezel

i **NOTE:** LCD panel is optional on the front bezel. If the front bezel has an LCD panel, see [LCD panel](#) section.

Removing the front bezel

Prerequisites

1. Follow the safety guidelines listed in the [Safety Instructions](#).
2. Keep the bezel key handy.

i **NOTE:** The bezel key is part of the bezel package.

Steps

1. **i** **NOTE:** The numbers on the image do not depict the exact steps. The numbers are for representation of sequence.
Unlock the bezel .
2. Press the release button, and remove the left end of the bezel.
3. Slide the tabs on the right end of the bezel out of the slots on the chassis and remove the bezel.

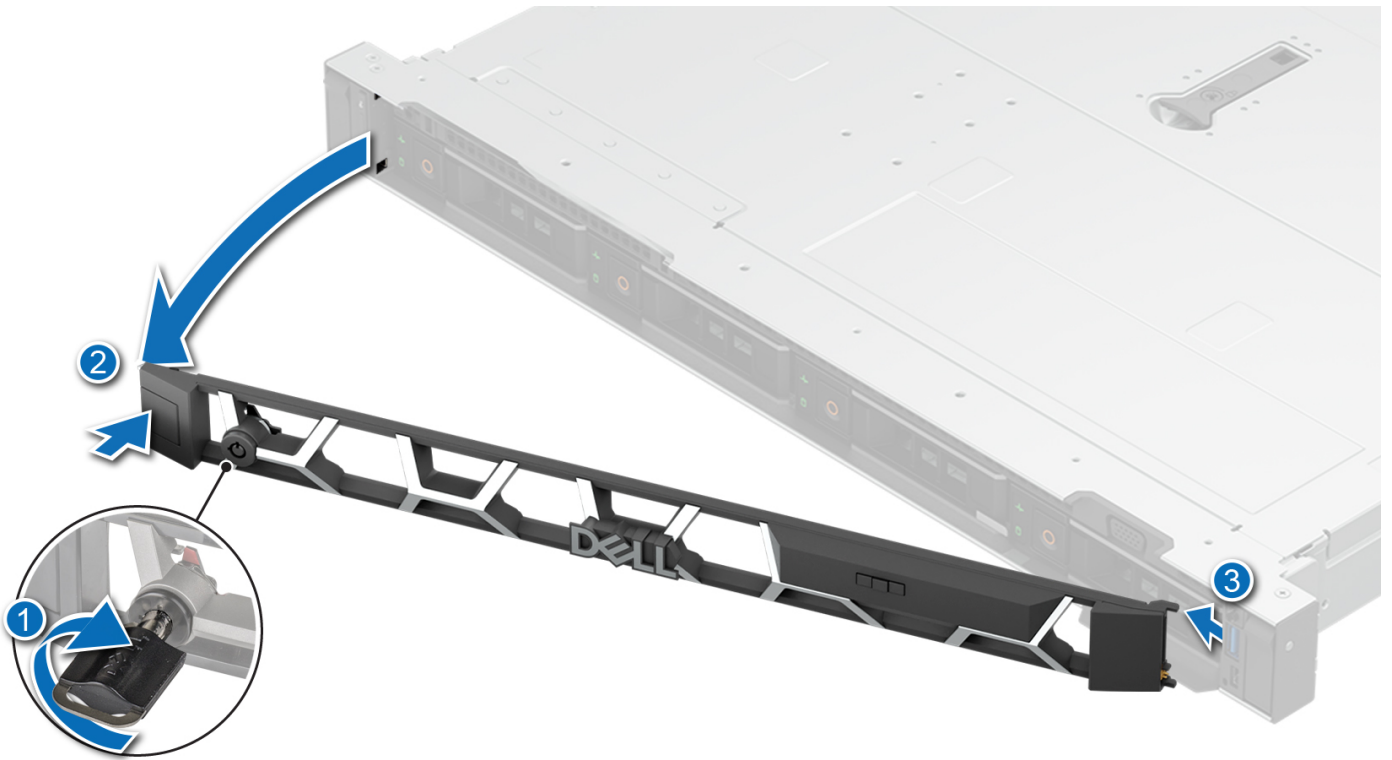

Figure 23. Removing the front bezel

Installing the front bezel

Prerequisites

1. Follow the safety guidelines listed in the [Safety Instructions](#).
2. Keep the bezel key handy.
 - i** **NOTE:** The bezel key is part of the bezel package.

Steps

1. Align and insert the tabs on the bezel into the slots on the chassis.
2. Press the bezel until the release button clicks in place.
3. Lock the bezel.



Figure 24. Installing the front bezel

System cover

Removing the system cover

Prerequisites

1. Follow the safety guidelines listed in the [Safety instructions](#).
2. Follow the procedure listed in the [Before working inside your system](#).
3. Power off the system, including any attached peripherals.
4. Disconnect the system from the electrical outlet and peripherals.

Steps

1. Use a 1/4 inch flat head or a Phillips #2 screwdriver to turn the lock counterclockwise to the unlock position.
2. Open the release latch until the system cover slides back.
3. Lift the cover from the system.

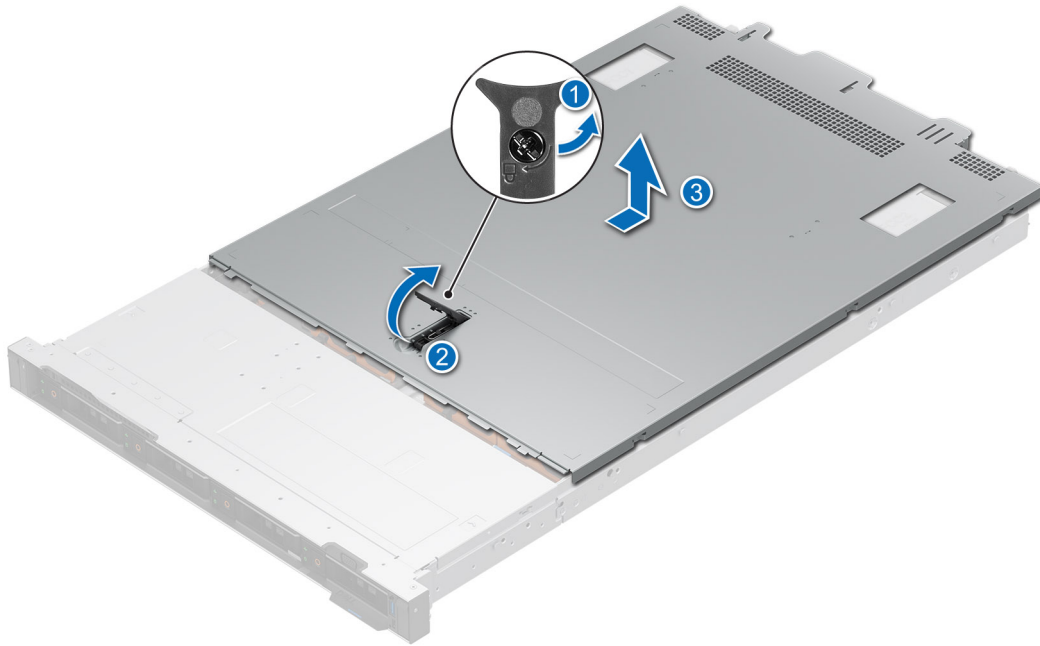

Figure 25. Removing the system cover

Next steps

1. [Replace the system cover.](#)

Installing the system cover

Prerequisites

1. Follow the safety guidelines listed in the [Safety instructions](#).
2. Follow the procedure listed in the [Before working inside your system](#).
3. Ensure that all internal cables are connected and placed out of the way, and no tools or extra parts are left inside the system.

Steps

1. Align the tabs on the system cover with the guide slots on the chassis.
2. Close the system cover release latch.
3. Using a 1/4 inch flat head or Phillips #2 screwdriver, turn the lock clockwise to the lock position.

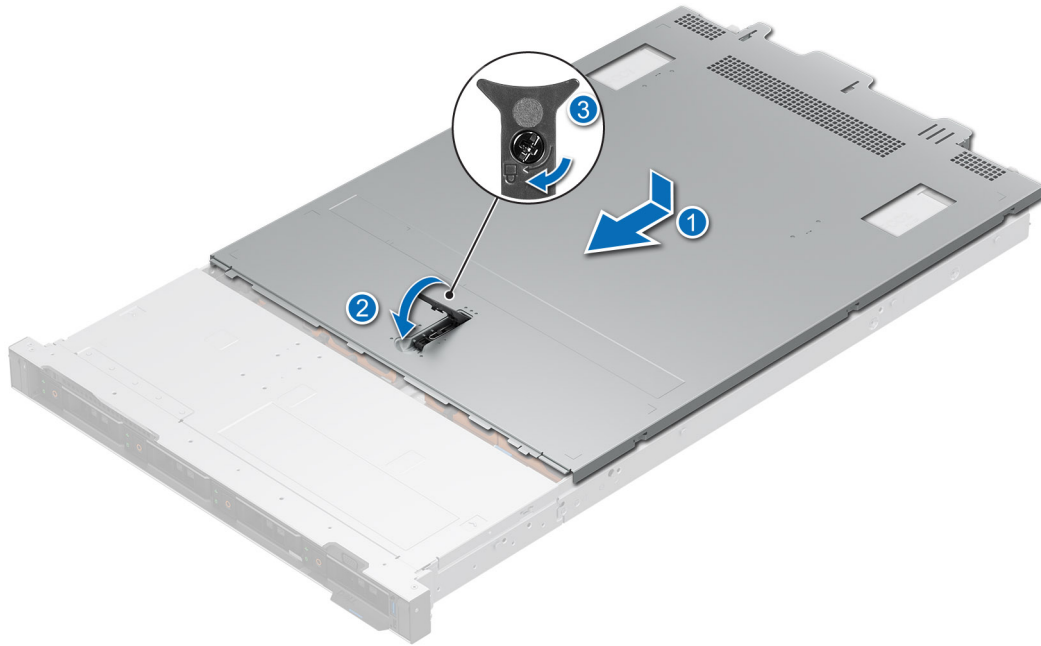

Figure 26. Installing the system cover

Next steps

Follow the procedure listed in [After working inside your system](#).

Drive backplane cover

Removing the drive backplane cover

Prerequisites

1. Follow the safety guidelines listed in the [Safety instructions](#).
2. Follow the procedure listed in the [Before working inside your system](#).

i **NOTE:** Route the cables properly to prevent the cables from being pinched or crimped.

Steps

1. Press and push the blue touch points to disengage the drive backplane cover.
2. Remove the cover from the chassis.

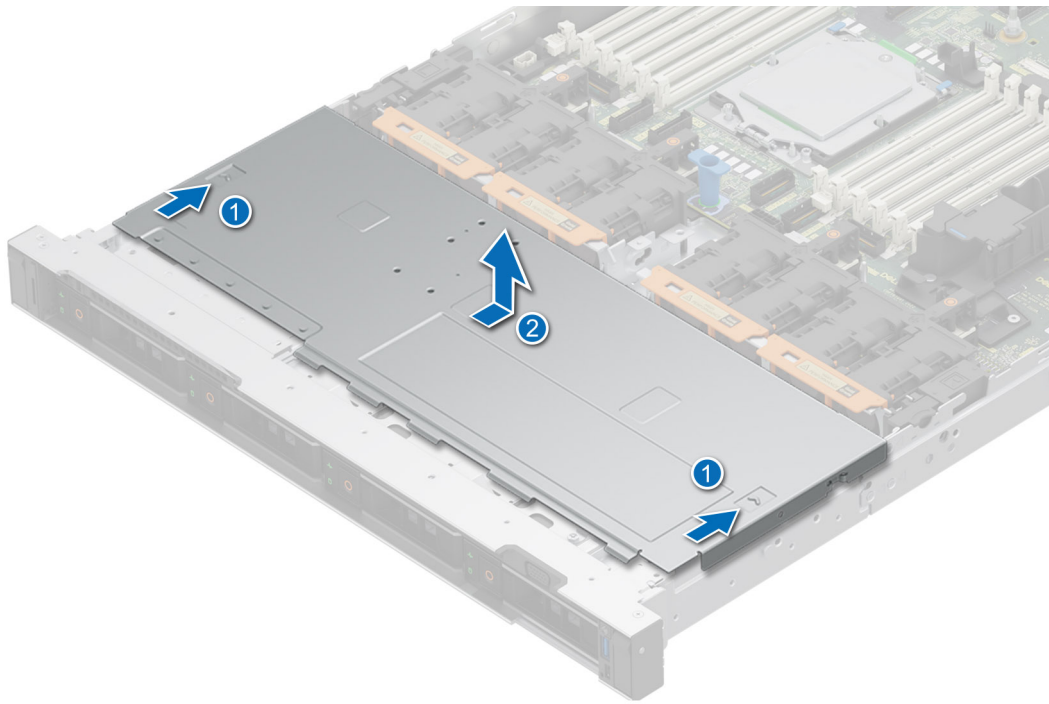

Figure 27. Removing the drive backplane cover

Next steps

1. [Install the drive backplane.](#)

Installing the drive backplane cover

Prerequisites

1. Follow the safety guidelines listed in the [Safety instructions](#).
2. Follow the procedure listed in the [Before working inside your system](#).

Steps

1. Align the tabs on the drive backplane cover with the guide slots on the system.
2. Slide the cover until it is securely seated.

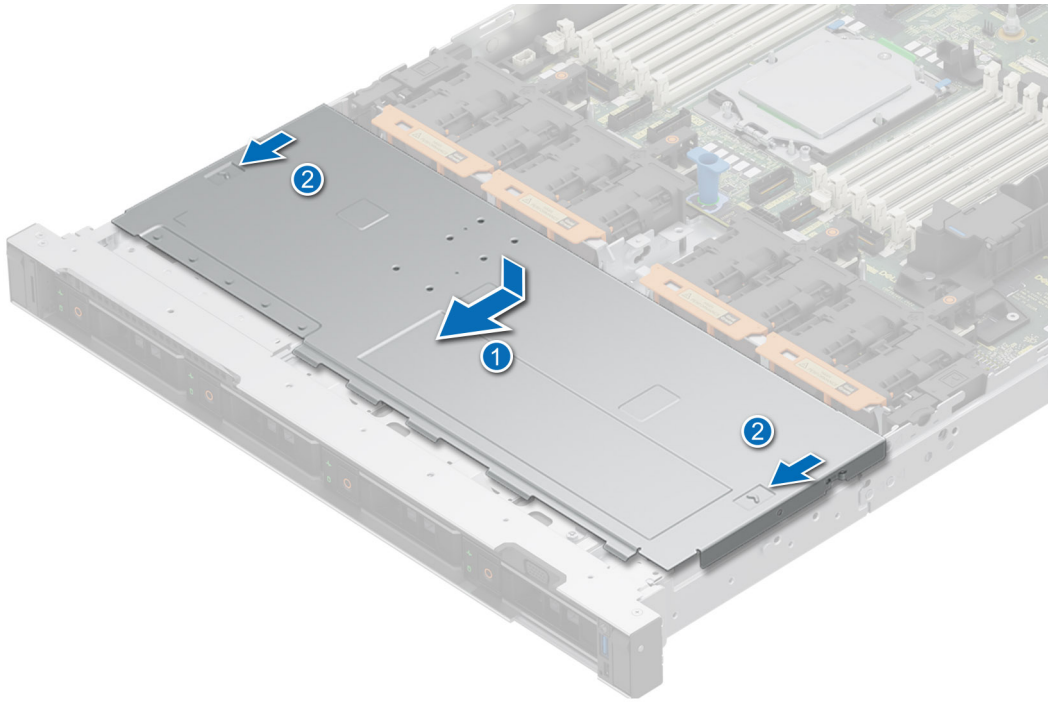

Figure 28. Installing the drive backplane cover

Next steps

Follow the procedure listed in [After working inside your system.](#)

Air shroud

Removing the air shroud

Prerequisites

1. Follow the safety guidelines listed in the [Safety instructions](#).
2. Follow the procedure listed in the [Before working inside your system](#).

CAUTION: Never operate your system with the air shroud removed. The system may get overheated quickly, resulting in shutdown of the system and loss of data.

Steps

Hold the air shroud at both the ends, and lift it from the system.

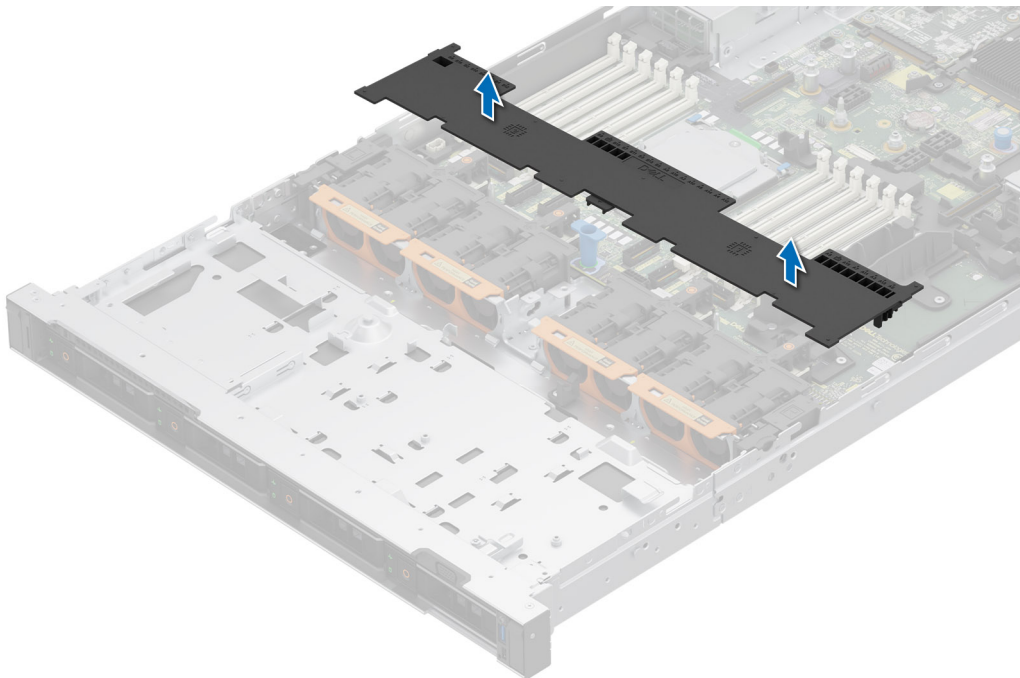

Figure 29. Removing the air shroud

Next steps

1. [Replace the air shroud](#).

Installing the air shroud

Prerequisites

1. Follow the safety guidelines listed in the [Safety instructions](#).
2. Follow the procedure listed in the [Before working inside your system](#).

Steps

1. Align the tabs on the air shroud with the slots on the chassis.

NOTE: Route the cables properly to prevent the cables from being pinched or crimped.

2. Lower the air shroud into the system until it is firmly seated.

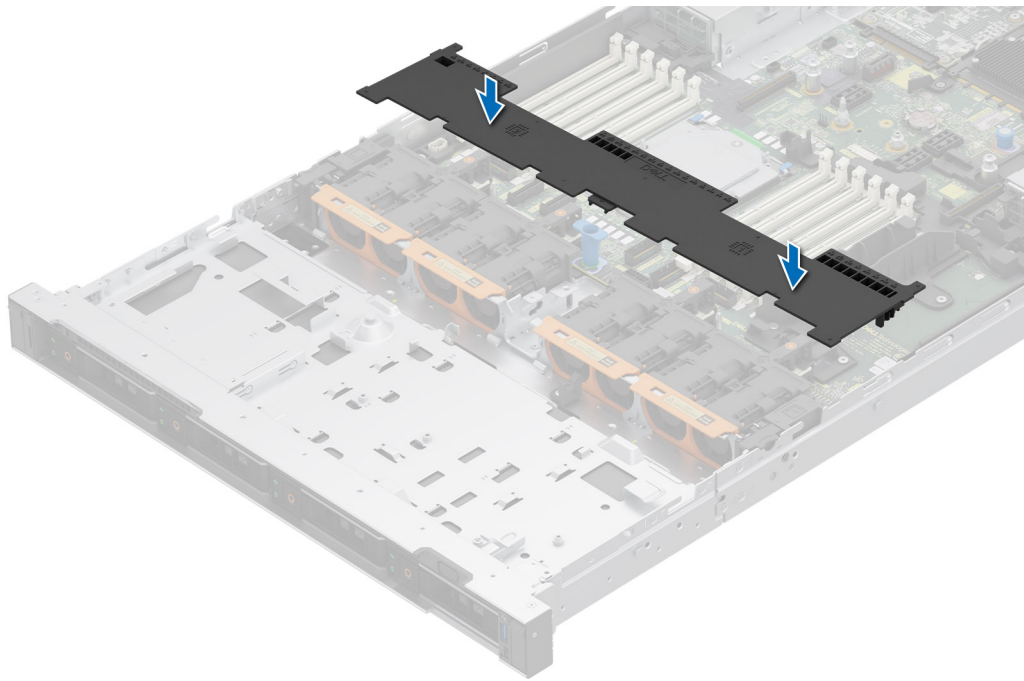

Figure 30. Installing the air shroud

Next steps

Follow the procedure listed in [After working inside your system](#).

Cooling fan

Removing a cooling fan

Prerequisites

1. Follow the safety guidelines listed in the [Safety instructions](#).
2. Follow the procedure listed in [Before working inside your system](#).
3. If installed, [Remove the air shroud](#).

NOTE: The procedure to remove standard, or High Performance gold (HPR Gold) fan is same.

Steps

Press the orange release tab and lift the cooling fan to disconnect the fan from the connector on the system board.

WARNING: Ensure not to tilt or rotate the cooling fan while removing from the system.

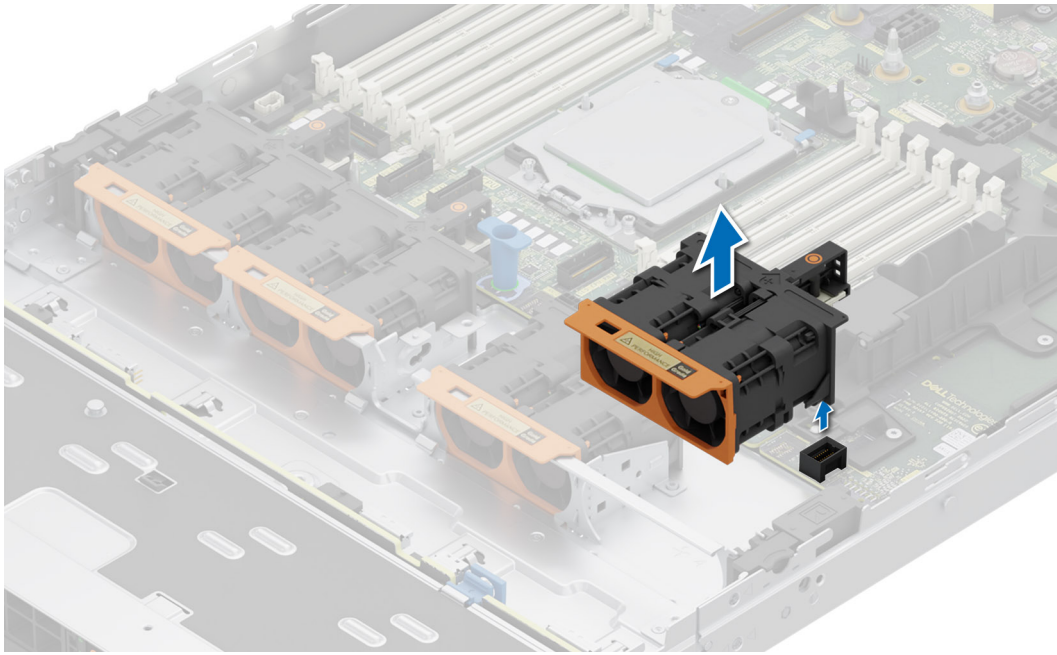

Figure 31. Removing a cooling fan

Next steps

1. [Replace a cooling fan.](#)

Installing a cooling fan

Prerequisites

1. Follow the safety guidelines listed in the [Safety instructions](#).
2. Follow the procedure listed in [Before working inside your system](#).
3. If installed, [Remove the air shroud](#).

(i) NOTE: The procedure to install standard (STD), or high-performance gold grade (HPR GOLD) fan is same.

Steps

Align and lower the cooling fan into the cooling fan assembly until the fan clicks into place.

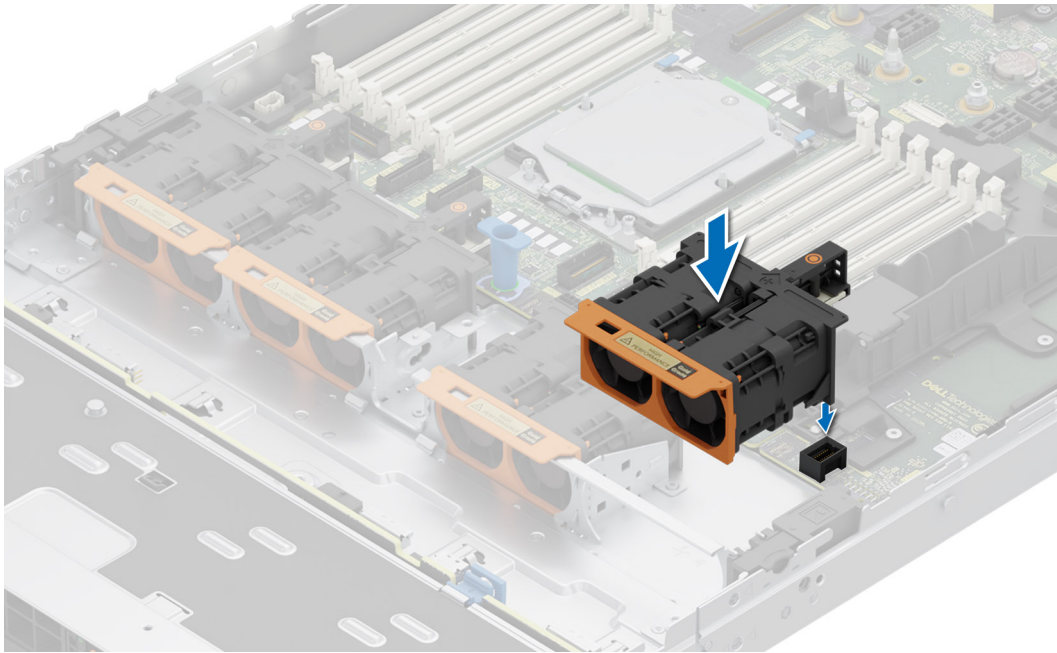

Figure 32. Installing a cooling fan

Next steps

1. If removed, [Install the air shroud](#).
2. Follow the procedure listed in [After working inside your system](#).

Drives

Removing a drive blank

Prerequisites

1. Follow the safety guidelines listed in the [Safety instructions](#).
2. Follow the procedure listed in the [Before working inside your system](#).

CAUTION: To maintain proper system cooling, drive blanks must be installed in all empty drive slots.

Steps

Press the release button, and slide the drive blank out of the drive slot.

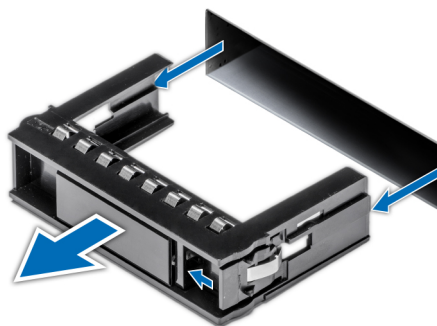

Figure 33. Removing a drive blank

Next steps

1. [Replace the drive blank.](#)

Installing a drive blank

Prerequisites

1. Follow the safety guidelines listed in the [Safety instructions](#).
2. Follow the procedure listed in the [Before working inside your system](#).

Steps

Slide the drive blank into the drive slot until the release button clicks into place.

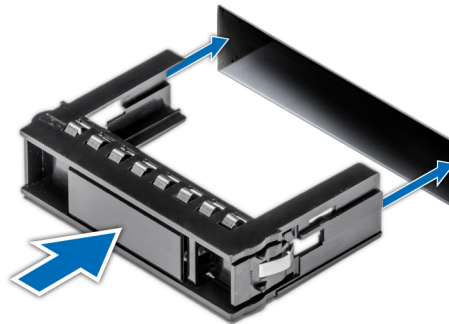

Figure 34. Installing a drive blank

Next steps

1. If removed, [install the front bezel](#).

Removing a drive carrier

Prerequisites

1. Follow the safety guidelines listed in the [Safety instructions](#).
2. [Remove the front bezel](#).
3. Using the management software, prepare the drive for removal. If the drive is online, the green activity or fault indicator flashes while the drive is turning off. When the drive indicators are off, the drive is ready for removal. For more information, see the storage controller documentation.

CAUTION: Before attempting to remove or install a drive while the system is running, see the documentation for the storage controller card to ensure that the host adapter is configured correctly to support drive removal and insertion.

CAUTION: To prevent data loss, ensure that your operating system supports drive installation. See the documentation supplied with your operating system.

Steps

1. Press the release button to open the drive carrier release handle.
2. Holding the drive carrier release handle, slide the drive carrier out of the drive slot.

NOTE: If you are not replacing the drive immediately, install a drive blank in the empty drive slot to maintain proper system cooling.



Figure 35. Removing a drive carrier

Next steps

Replace the drive or a drive blank.

Installing the drive carrier

Prerequisites

- ⚠ **CAUTION:** Before removing or installing a drive while the system is running, see the documentation for the storage controller card to ensure that the host adapter is configured correctly to support drive removal and insertion.
- ⚠ **CAUTION:** Combining SAS and SATA drives in the same RAID volume is not supported.
- ⚠ **CAUTION:** When installing a drive, ensure that the adjacent drives are fully installed. Inserting a drive carrier and attempting to lock its handle next to a partially installed carrier can damage the partially installed carrier's shield spring and make it unusable.
- ℹ **NOTE:** Ensure that the drive carrier's release handle is in the open position before inserting the carrier into the slot.
- ⚠ **CAUTION:** To prevent data loss, ensure that your operating system supports hot-swap drive installation. See the documentation supplied with your operating system.
- ⚠ **CAUTION:** When a replacement hot swappable drive is installed and the system is powered on, the drive automatically begins to rebuild. Ensure that the replacement drive is blank or contains data that you wish to overwrite. Any data on the replacement drive is immediately lost after the drive is installed.

1. Follow the safety guidelines listed in the [Safety instructions](#).
2. [Remove the front bezel](#).
3. Remove the drive carrier or remove the drive blank when you want to assemble the drives into the system.

Steps

1. Slide the drive carrier into the drive slot and push until the drive connects with the backplane.
2. Close the drive carrier release handle to lock the drive in place.



Figure 36. Installing a drive carrier

Next steps

install the front bezel.

Removing the drive from the drive carrier

Prerequisites

1. Follow the safety guidelines listed in the [Safety instructions](#).
2. [Remove the drive carrier](#).

Steps

1. Using a Phillips #1 screwdriver, remove the screws from the slide rails on the drive carrier.

NOTE: If the drive carrier has Torx screw, use Torx 6 (for 2.5-inch drive) or Torx 8 (for 3.5-inch drive) screwdriver to remove the drive.



2. Lift the drive out of the drive carrier.

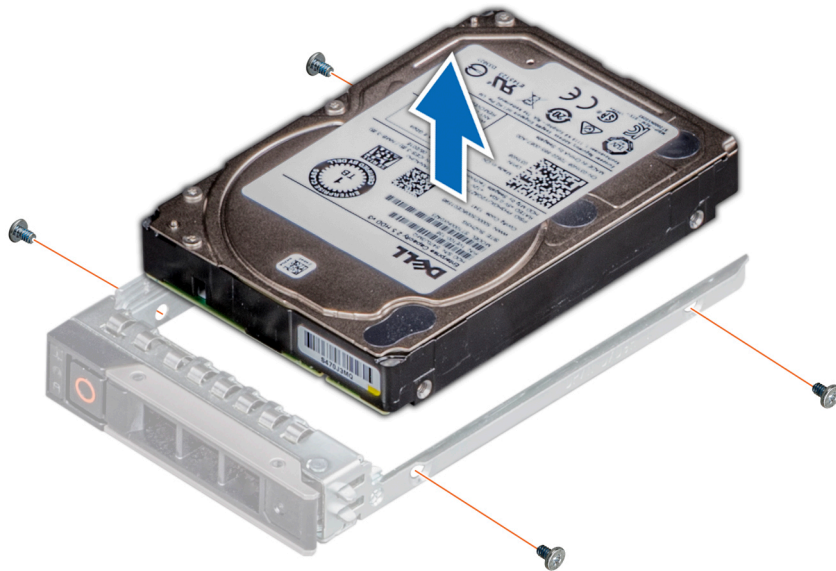

Figure 37. Removing the drive from the drive carrier

Next steps

Install the drive into the drive carrier.

Installing the drive into the drive carrier

Prerequisites

1. Follow the safety guidelines listed in the [Safety instructions](#).
2. [Remove the drive blank](#).

Steps

1. Insert the drive into the drive carrier with the drive connector facing towards the rear of the carrier.
2. Align the screw holes on the drive with the screws holes on the drive carrier.
3. Using a Phillips #1 screwdriver, secure the drive to the drive carrier with the screws.

NOTE: When installing a drive into the drive carrier, ensure that the screws are torqued to 4 lbf-in.

NOTE: If the drive carrier has Torx screw, use Torx 6 (for 2.5-inch drive) or Torx 8 (for 3.5-inch drive) screwdriver to install the drive.





Figure 38. Installing a drive into the drive carrier

Next steps

1. [Install the drive carrier.](#)

Rear drive module

Removing the rear drive module

Prerequisites

1. Follow the safety guidelines listed in the [Safety instructions](#).
2. Follow the procedure listed in the [Before working inside your system](#).
3. [Remove the air shroud.](#)
4. [Remove the rear drives.](#)
5. Disconnect all the cables from the rear drive module.
6. If installed, [remove the expansion card riser.](#)

Steps

1. Using a Phillips #1 screwdriver, loosen the captive screws on the rear drive module.
2. Slide the rear drive module and lift it away from the system.

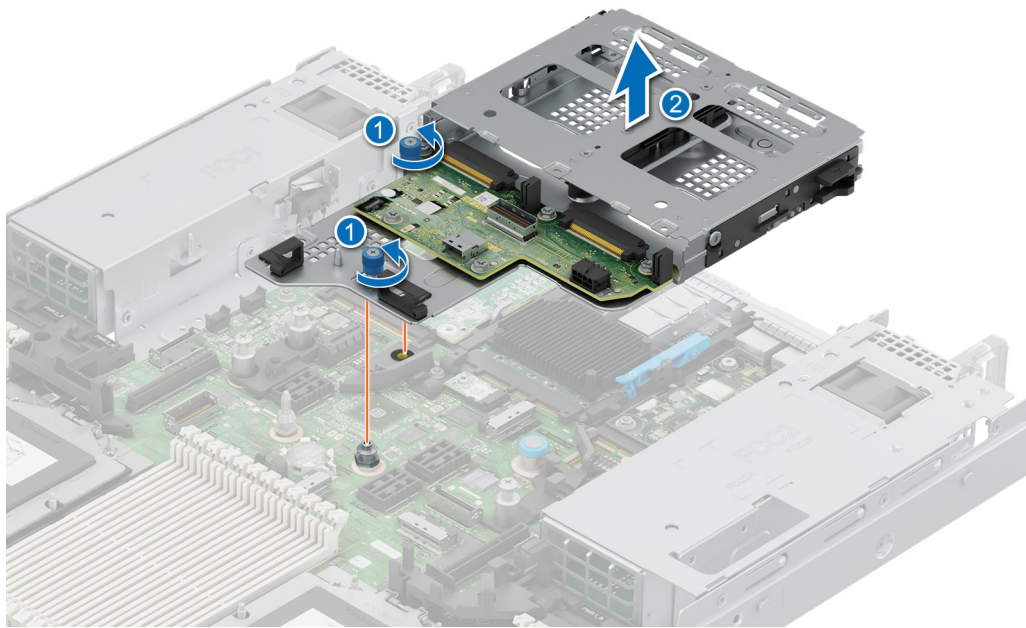

Figure 39. Removing the rear HDD

Next steps

1. [Replace the rear drive module.](#)

Installing the rear drive module

Prerequisites

1. Follow the safety guidelines listed in the [Safety instructions](#).
2. Follow the procedure listed in the [Before working inside your system](#).
3. [Remove the air shroud.](#)

Steps

1. Align the rear drive module with the guide on the system board.
2. Lower the rear drive module and slide till it clicks.
3. Using a Phillips #1 screwdriver, tighten the captive screws on the rear drive module.

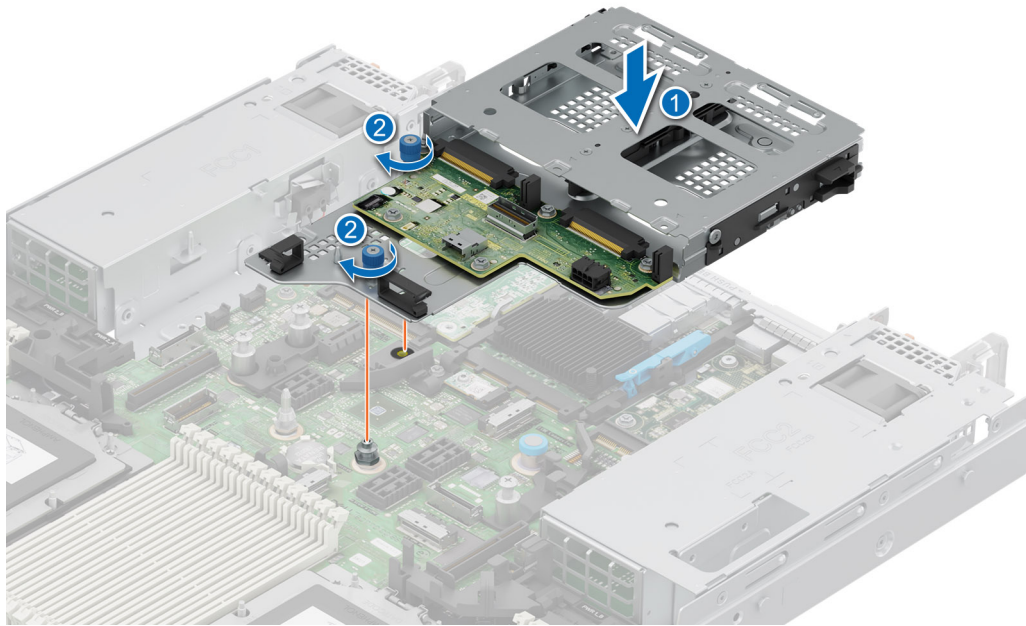

Figure 40. Installing rear drive module

Next steps

1. Connect all the cables to the rear drive module.
2. [Install the rear drives.](#)
3. [Install the air shroud.](#)
4. Follow the procedure listed in [After working inside your system](#)

Drive backplane

Drive backplane

Depending on your system configuration, the drive backplanes supported are listed here:

Table 64. Supported backplane options

| System | Supported hard drives options |
|-----------------|--|
| PowerEdge R6515 | 3.5 inch (x4) SAS, SATA backplane |
| | 2.5-inch (x8) NVMe backplane |
| | 2.5 inch (x10) SAS, SATA or NVMe backplane |



Figure 41. 4 x 3.5-inch drive backplane

1. BP_SIG_PWR_1 (backplane power and signal cable to system board)



Figure 42. 8 x 2.5-inch drive backplane

- | | |
|----------------------------------|--|
| 1. DST_PB2 (PCIe/NVMe connector) | 2. DST_SB1(backplane to front PERC) |
| 3. DST_PA2 (PCIe/NVMe connector) | 4. BP_PWR_1 (backplane power and signal cable to system board) |
| 5. DST_PB1 (PCIe/NVMe connector) | 6. DST_SA1(PCIe/NVMe connector) |
| 7. PWR_CTRL | 8. DST_PA1 (PCIe/NVMe connector) |

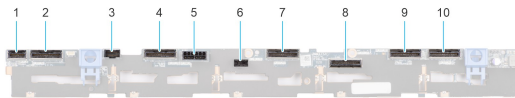

Figure 43. 10 x 2.5-inch drive backplane

- | | |
|--|-----------------------------------|
| 1. DST_SB1 | 2. DST_PA3 (PCIe/NVMe connector) |
| 3. P8 | 4. DST_PB2 (PCIe/NVMe connector) |
| 5. BP_PWR_1 (backplane power and signal cable to system board) | 6. PWR_CTRL |
| 7. DST_PA2 (PCIe/NVMe connector) | 8. DST_SA1 (PERC to backplane) |
| 9. DST_PB1 (PCIe/NVMe connector) | 10. DST_PA1 (PCIe/NVMe connector) |

Removing the drive backplane

Prerequisites

CAUTION: To prevent damage to the drives and backplane, remove the drives from the system before removing the backplane.

CAUTION: Note the number of each drive and temporarily label them before you remove the drive so that you can reinstall them in the same location.

NOTE: The procedure to remove the backplane is similar for all backplane configurations.

1. Follow the safety guidelines listed in the [Safety instructions](#).
2. Follow the procedure listed in the [Before working inside your system](#).
3. [Remove the backplane cover](#).
4. If installed, [remove the air shroud](#).
5. [Remove the drives](#).
6. Observe and disconnect the drive backplane cables from the connector on the system board and backplane.

NOTE: Refer [cable routing](#) topic for more information.

Steps

1. Press the release tab to disengage the drive backplane from the hooks on the system.
2. Lift and pull the drive backplane out of the system.

NOTE: To avoid damaging the backplane, ensure that you move the control panel cables from the cable routing clips before removing the backplane.

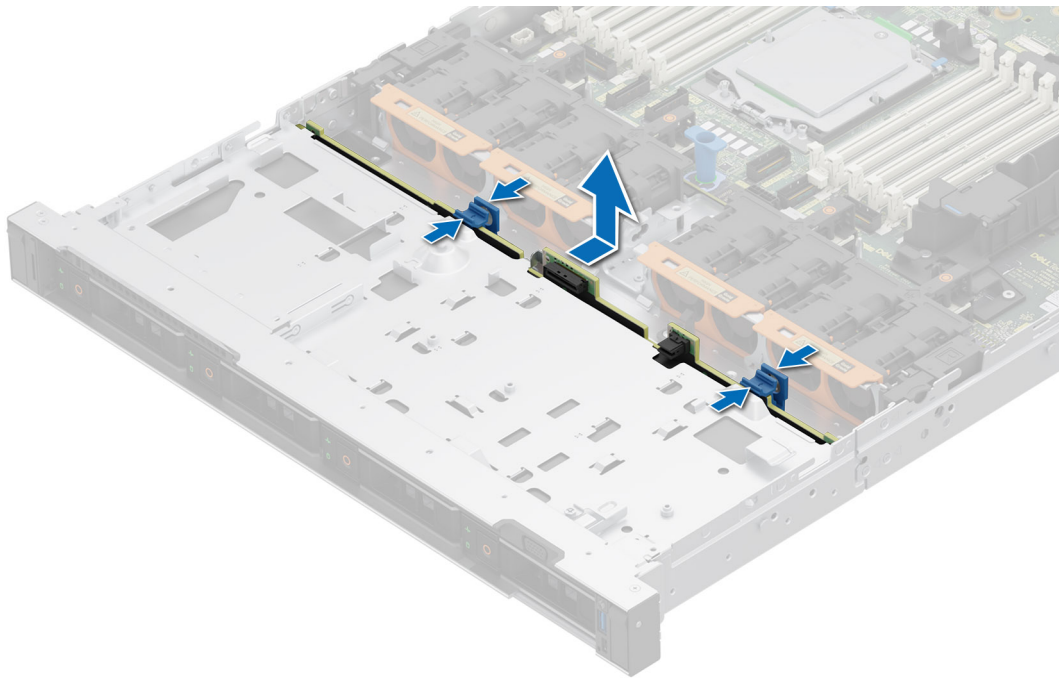

Figure 44. Removing the drive backplane

Next steps

1. [Replace the drive backplane.](#)

Installing the drive backplane

Prerequisites

1. Follow the safety guidelines listed in the [Safety instructions](#).
2. Follow the procedure listed in the [Before working inside your system](#).
3. [Remove the backplane cover.](#)
4. If installed, [remove the air shroud.](#)
5. [Remove the drives.](#)
6. Observe and disconnect the drive backplane cables from the connector on the system board and backplane.

i **NOTE:** Refer [cable routing](#) topic for more information.

i **NOTE:** To avoid damaging the backplane, ensure to move the control panel cables from the cable routing clips before removing the backplane.

i **NOTE:** Route the cable properly when you replace it to prevent the cable from being pinched or crimped.

Steps

1. Align the slots on the drive backplane with the guides on the system.
2. Slide the drive backplane into the guides and lower the backplane until the blue release tab clicks into place.

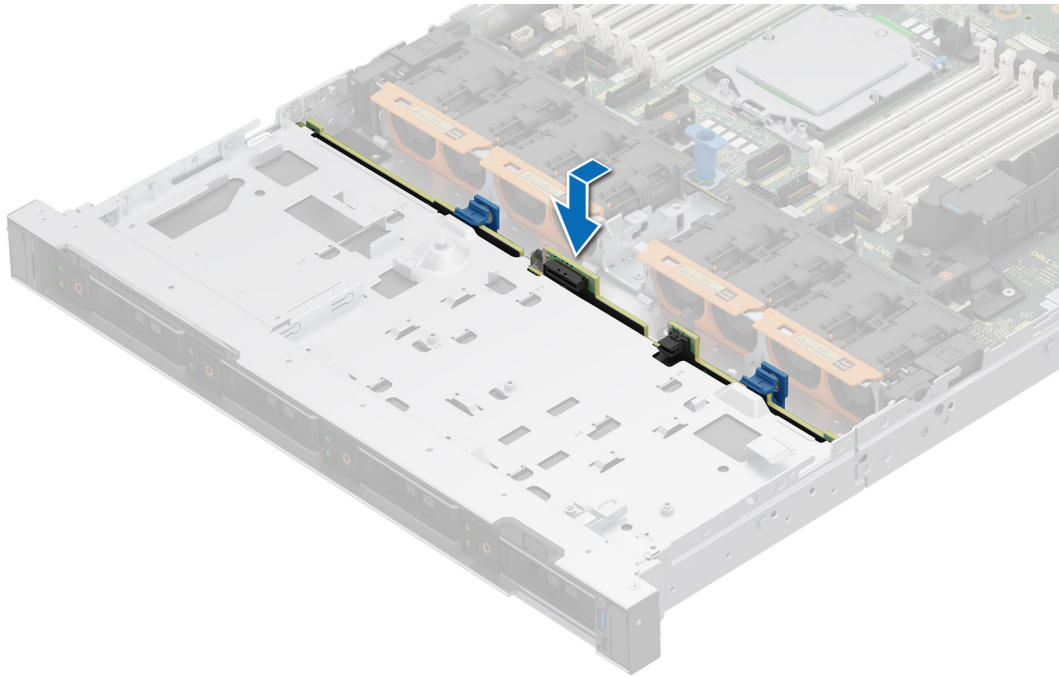

Figure 45. Installing the drive backplane

Next steps

1. Connect the drive backplane cables to the connectors on the system board and backplane.
2. [Install the drives.](#)
3. If removed, [install the air shroud.](#)
4. [Install the drive backplane cover.](#)
5. Follow the procedure listed in [After working inside your system.](#)

Side wall brackets

Side and center bracket perfect sealing

The topic lists details on side (right and left) and center bracket perfect sealing available on different configurations.

Table 65. Side and center bracket perfect sealing

| Configuration | Foam installed on the right side bracket | Foam installed on the left side bracket | Foam installed on the center bracket |
|---|--|---|--------------------------------------|
| No BP (0 drive configuration) chassis | Installed | Installed | Installed |
| 10 x 2.5 inch chassis (SAS/SATA/NVMe) chassis | Installed | Installed | Installed |
| 8 x 2.5 inch universal with fPERC 11 | Installed | Not installed | Not installed |
| 10 x 2.5 inch (NVMe) (1CPU) | Installed | Not installed | Not installed |

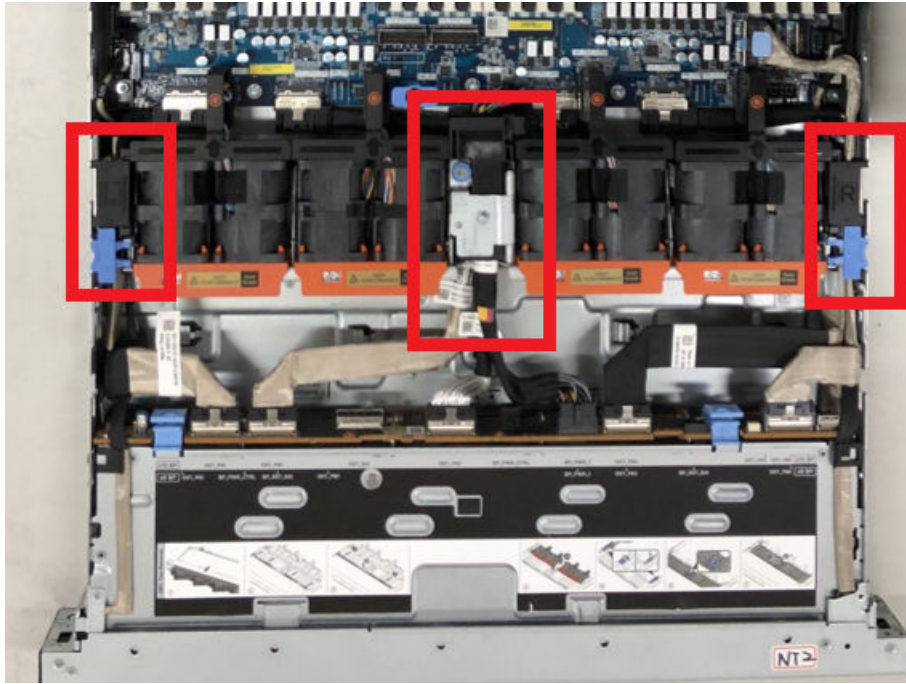

Figure 46. Right ,left, and center brackets

Removing the side wall bracket

There are two side wall brackets on either side of the system. The procedure to remove is similar.

Prerequisites

1. Follow the safety guidelines listed in the [Safety instructions](#).
2. Follow the procedure listed in the [Before working inside your system](#).
3. If required, [remove the drive backplane cover](#).
4. If installed, [remove the air shroud](#).
5. [Remove the cooling fan](#).

i **NOTE:** Ensure that you note the routing of the cables as you remove them from the system board. Route the cables properly when you replace them to prevent the cables from being pinched or crimped.

Steps

1. Press the blue side tabs to release the side wall cable holder.
i **NOTE:** Move the cables out of the side wall cable holder.
2. Press the center tab to release the bracket from the chassis, and lift it away from the system.

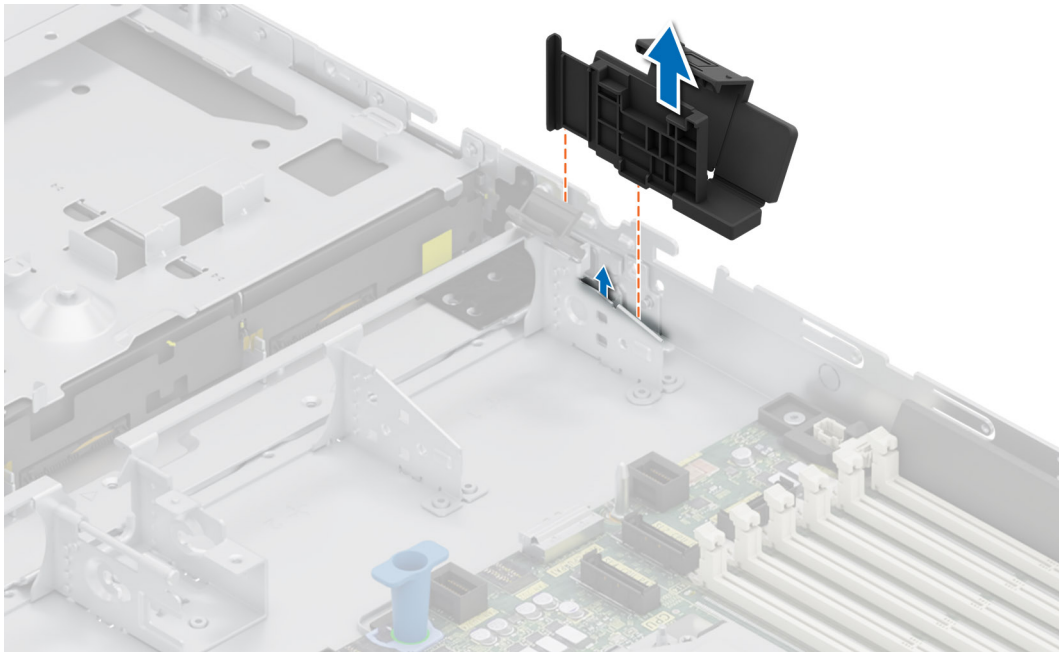

Figure 47. Removing the side wall bracket

Next steps

1. [Replace the side wall bracket.](#)

Installing the side wall bracket

There are two side wall brackets on either side of the system. The procedure to install is similar.

Prerequisites

1. Follow the safety guidelines listed in the [Safety instructions](#).
2. Follow the procedure listed in the [Before working inside your system](#).
3. If required, [remove the drive backplane cover](#).
4. If installed, [remove the air shroud](#).
5. [Remove the cooling fan](#).

i **NOTE:** Ensure that you note the routing of the cables as you remove them from the system board. Route the cables properly when you replace them to prevent the cables from being pinched or crimped.

Steps

1. Align the guide slots on the side wall bracket with the guides on the system and slide until the cover is seated firmly.

i **NOTE:** Route the cables through the side wall cable holder.

2. Close the side wall cable holder until the holder clicks into place.

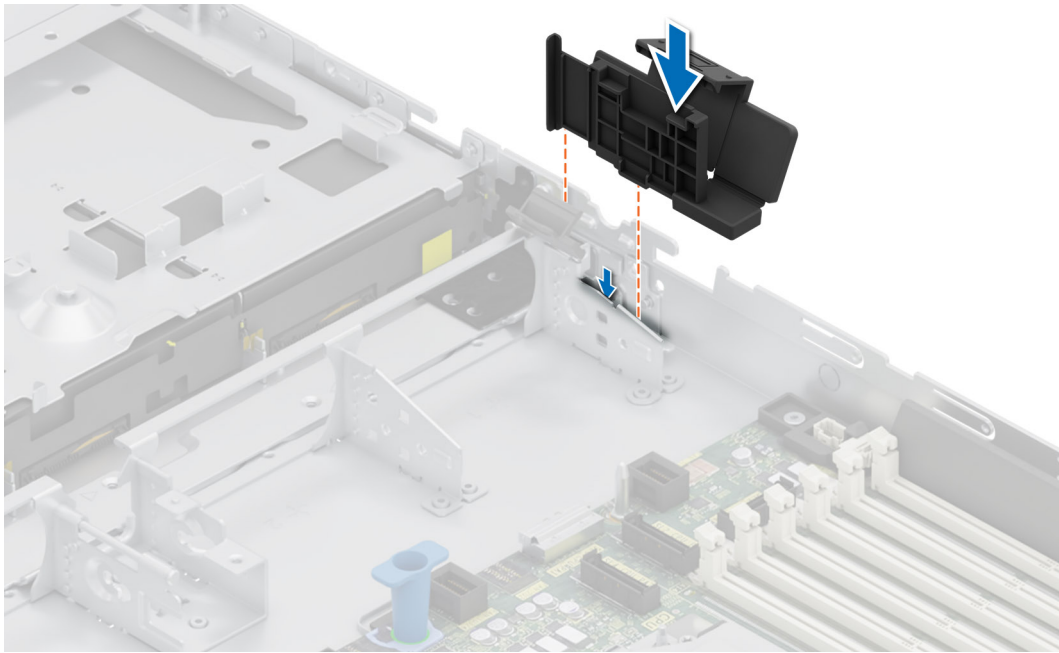

Figure 48. Installing the side wall bracket

Next steps

1. [Replace the cooling fan.](#)
2. If removed, [install the air shroud.](#)
3. If removed, [install the drive backplane cover.](#)
4. Follow the procedure listed in the [After working inside your system.](#)

Cable routings



Figure 49. 4 x 3.5-inch SAS3/SATA RAID

NOTE: Follow the sequential order as shown in the table to remove the cables, to install the cables follow the reverse sequential order.

Table 66. 4 x 3.5-inch SAS3/SATA RAID

| Order | From | To |
|-------|--|--------------------------------------|
| 1 | SIG_PWR_1 (system board power connector) | BP_PWR_1 (backplane power connector) |
| 2 | SL1 (signal connector on system board) | CTRL_DST_PA1 (front PERC) |

NOTE: Follow the sequential order as shown in the table to remove the cables, to install the cables follow the reverse sequential order.

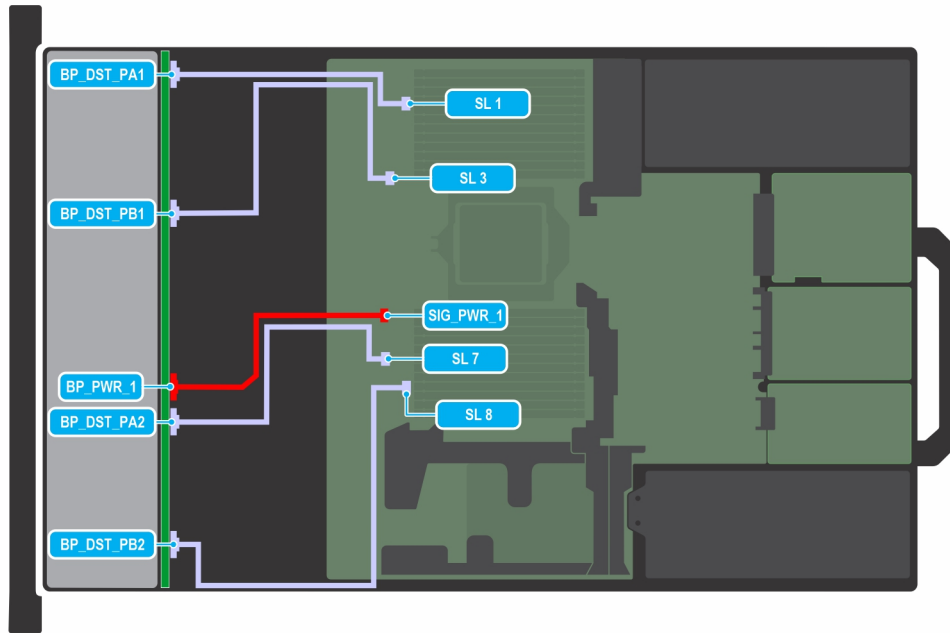

Figure 50. 8 x 2.5-inch NVMe

NOTE: Follow the sequential order as shown in the table to remove the cables, to install the cables follow the reverse sequential order.

Table 67. 8 x 2.5-inch NVMe

| Order | From | To |
|-------|--|---|
| 1 | SIG_PWR_1 (system board power connector) | BP_PWR_1 (backplane power connector) |
| 2 | SL1 (signal connector on system board) | BP_DST_PA1 (backplane signal connector) |
| 3 | SL3 (signal connector on system board) | BP_DST_PB1 (backplane signal connector) |
| 4 | SL7 (signal connector on system board) | BP_DST_PA2 (backplane signal connector) |
| 5 | SL8 (signal connector on system board) | BP_DST_PB2 (backplane signal connector) |

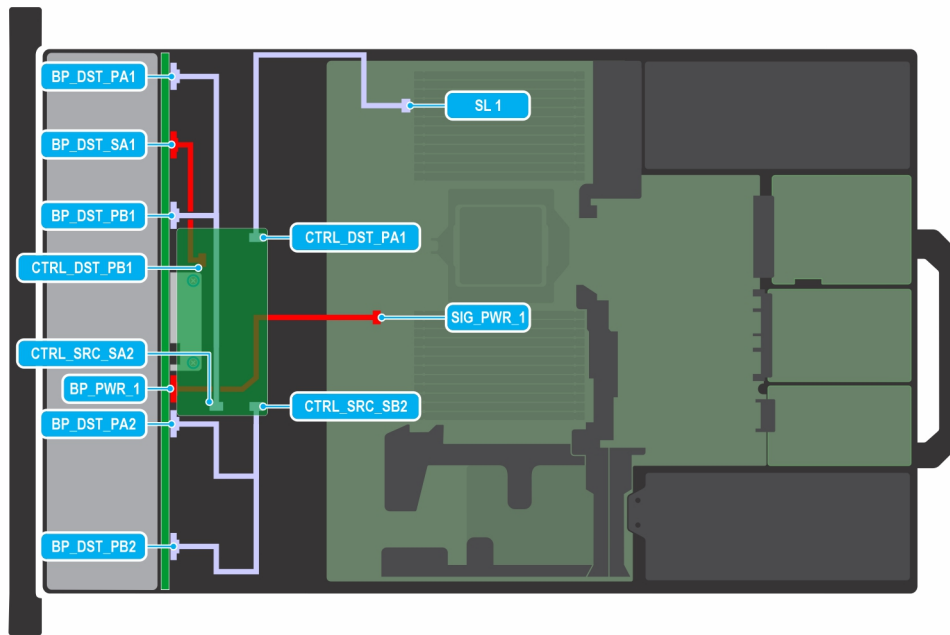

Figure 51. 8 x 2.5-inch NVMe RAID (w/ FPERC11 N)

NOTE: Follow the sequential order as shown in the table to remove the cables, to install the cables follow the reverse sequential order.

Table 68. 8 x 2.5-inch NVMe RAID (w/ FPERC11 N)

| Order | From | To |
|-------|--|--|
| 1 | SIG_PWR_1 (system board power connector) | BP_PWR_1 (backplane power connector) |
| 2 | SL1 (signal connector on system board) | CTRL_DST_PA1 (front PERC) |
| 3 | CTRL_SRC_SA2 (front PERC) | BP_DST_PA1 & BP_DST_PB1 (backplane signal connector) |
| 4 | CTRL_SRC_SB2 (front PERC) | BP_DST_PA2 & BP_DST_PB2 (backplane signal connector) |
| 5 | CTRL_DST_PB1 (front PERC) | BP_DST_SA1 (front PERC power connector) |

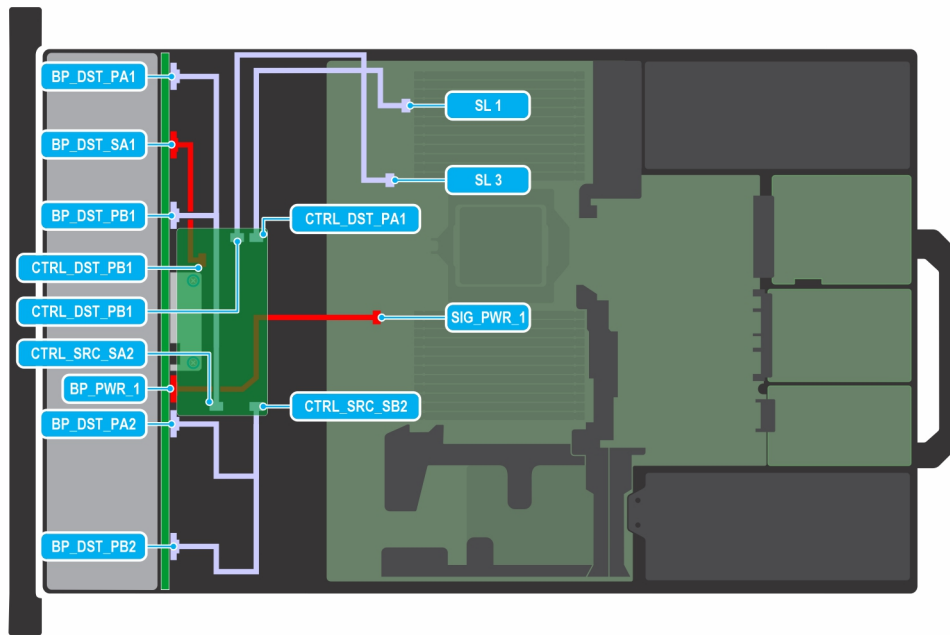

Figure 52. 8 x 2.5-inch NVMe RAID (w/ FPERC12)

NOTE: Follow the sequential order as shown in the table to remove the cables, to install the cables follow the reverse sequential order.

Table 69. 8 x 2.5-inch NVMe RAID (w/ FPERC12)

| Order | From | To |
|-------|--|--|
| 1 | SIG_PWR_1 (system board power connector) | BP_PWR_1 (backplane power connector) |
| 2 | SL1 (signal connector on system board) | CTRL_DST_PA1 (front PERC) |
| 3 | CTRL_SRC_SA2 (front PERC) | BP_DST_PA1 & BP_DST_PB1 (backplane signal connector) |
| 4 | CTRL_SRC_SB2 (front PERC) | BP_DST_PA2 & BP_DST_PB2 (backplane signal connector) |
| 5 | CTRL_DST_PB1 (front PERC) | BP_DST_SA1 (front PERC power connector) |
| 6 | SL3 (signal connector on system board) | CTRL_DST_PB1 (front PERC) |

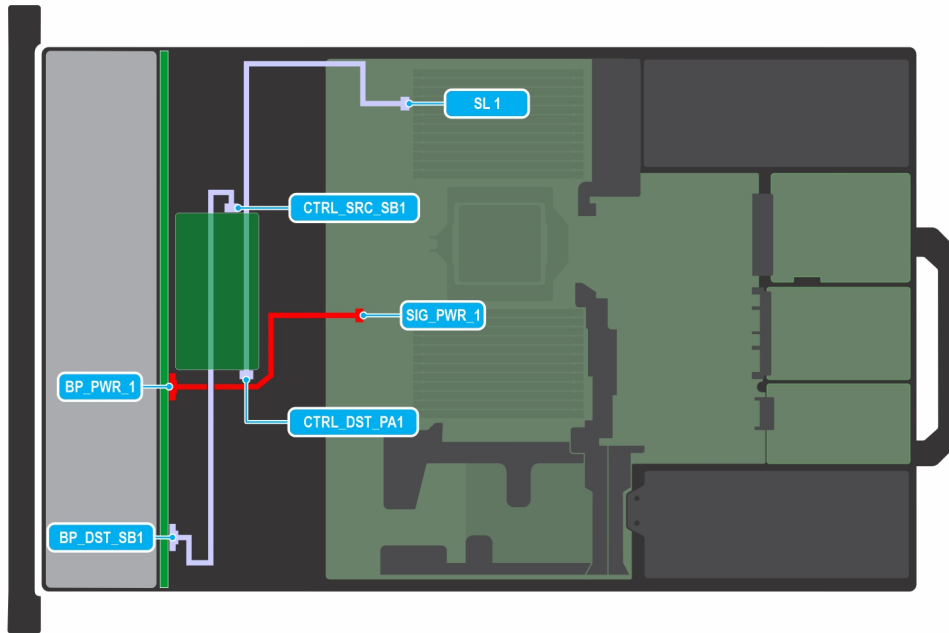

Figure 53. 10 x 2.5-inch SAS4/SATA RAID (w/ FPERC11)

NOTE: Follow the sequential order as shown in the table to remove the cables, to install the cables follow the reverse sequential order.

Table 70. 10 x 2.5-inch SAS4/SATA RAID (w/ FPERC11)

| Order | From | To |
|-------|--|---|
| 1 | SIG_PWR_1 (system board power connector) | BP_PWR_1 (backplane power connector) |
| 2 | SL1 (signal connector on system board) | CTRL_DST_PA1 (front PERC) |
| 3 | CTRL_SRC_SB1 (front PERC) | BP_DST_SB1 (backplane signal connector) |

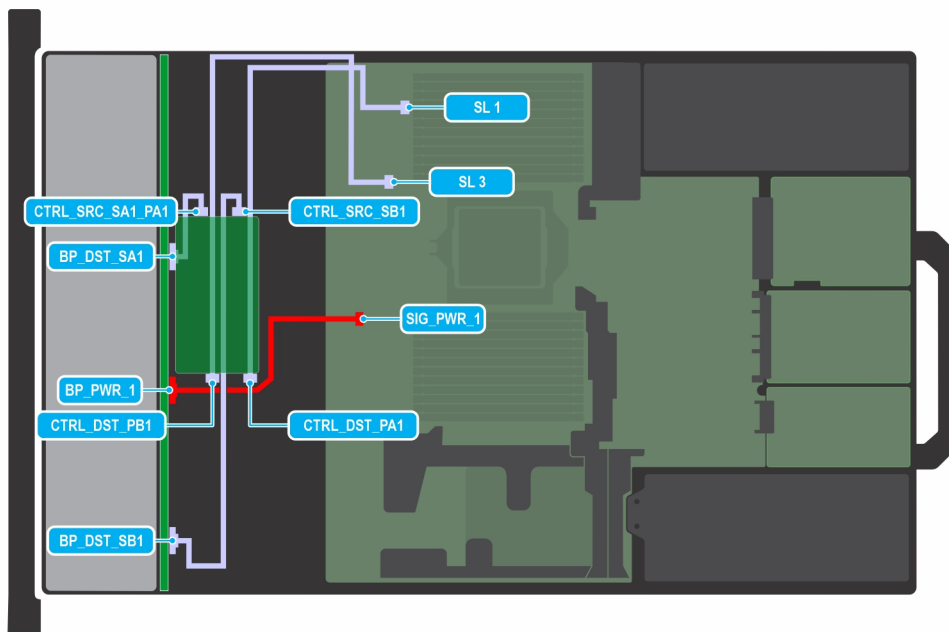

Figure 54. 10 x 2.5-inch SAS4/SATA RAID (w/ FPERC12)

NOTE: Follow the sequential order as shown in the table to remove the cables, to install the cables follow the reverse sequential order.

Table 71. 10 x 2.5-inch SAS4/SATA RAID (w/ FPERC12)

| Order | From | To |
|-------|--|---|
| 1 | SIG_PWR_1 (system board power connector) | BP_PWR_1 (backplane power connector) |
| 2 | SL1 (signal connector on system board) | CTRL_DST_PA1 (front PERC) |
| 3 | SL3 (signal connector on system board) | CTRL_DST_PB1 (front PERC) |
| 4 | CTRL_SRC_SB1 (front PERC) | BP_DST_SB1 (backplane signal connector) |
| 5 | CTRL_SRC_SA1_PA1 (front PERC) | BP_DST_SA1 (backplane signal connector) |

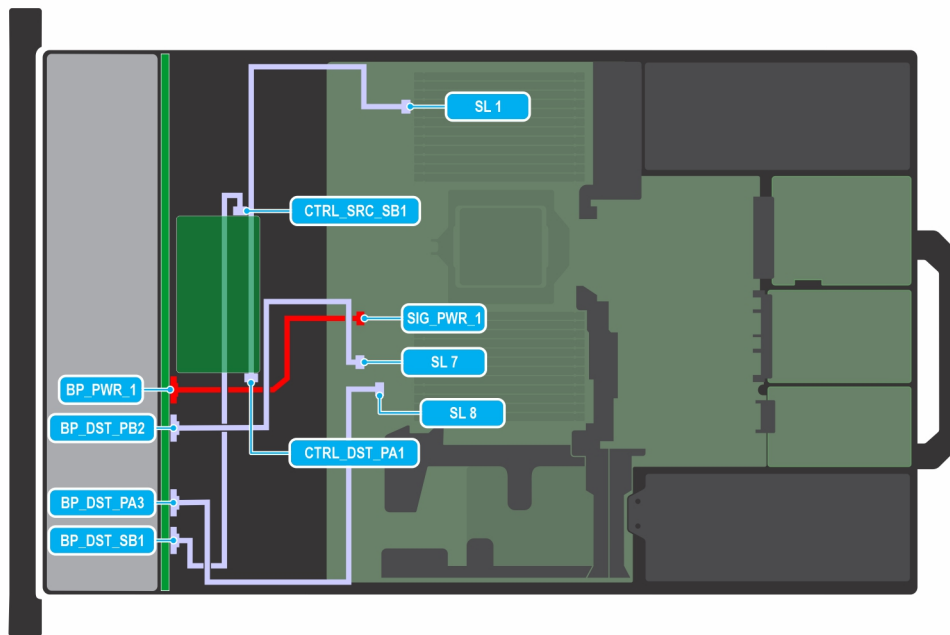

Figure 55. 10 x 2.5-inch w/ 4x Uni G4 (w/ FPERC11)

NOTE: Follow the sequential order as shown in the table to remove the cables, to install the cables follow the reverse sequential order.

Table 72. 10 x 2.5-inch w/ 4x Uni G4 (w/ FPERC11)

| Order | From | To |
|-------|--|---|
| 1 | SIG_PWR_1 (system board power connector) | BP_PWR_1 (backplane power connector) |
| 2 | SL1 (signal connector on system board) | CTRL_DST_PA1 (front PERC) |
| 3 | CTRL_SRC_SB1 (front PERC) | BP_DST_SB1 (backplane signal connector) |
| 4 | SL7 (signal connector on system board) | BP_DST_PB2 (backplane signal connector) |
| 5 | SL8 (signal connector on system board) | BP_DST_PA3 (backplane signal connector) |

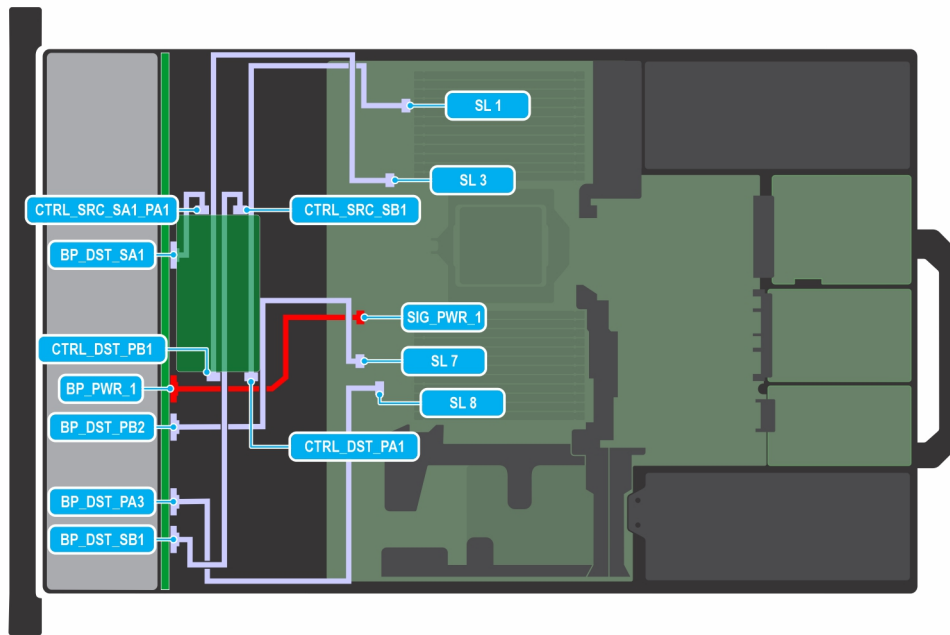

Figure 56. 10 x 2.5-inch w/ 4x Uni G4 (w/ FPERC12)

NOTE: Follow the sequential order as shown in the table to remove the cables, to install the cables follow the reverse sequential order.

Table 73. 10 x 2.5-inch w/ 4x Uni G4 (w/ FPERC11)

| Order | From | To |
|-------|--|---|
| 1 | SIG_PWR_1 (system board power connector) | BP_PWR_1 (backplane power connector) |
| 2 | SL1 (signal connector on system board) | CTRL_DST_PA1 (front PERC) |
| 3 | SL3 (signal connector on system board) | CTRL_DST_PB1 (front PERC) |
| 4 | CTRL_SRC_SB1 (front PERC) | BP_DST_SB1 (backplane signal connector) |
| 5 | CTRL_SRC_SA1_PA1 (front PERC) | BP_DST_SA1 (backplane signal connector) |
| 6 | SL7 (signal connector on system board) | BP_DST_PB2 (backplane signal connector) |
| 7 | SL8 (signal connector on system board) | BP_DST_PA3 (backplane signal connector) |

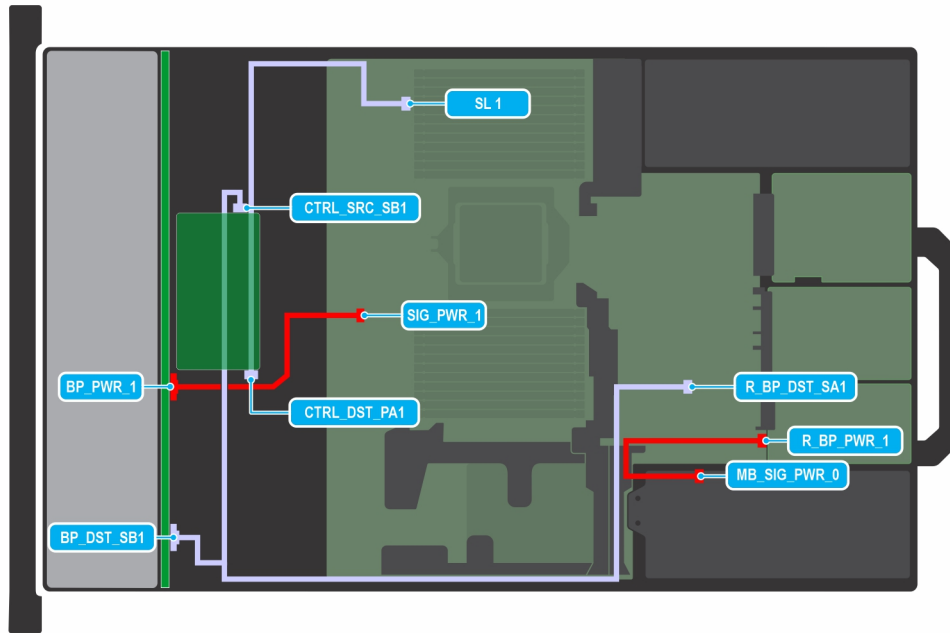

Figure 57. 10 x 2.5-inch SAS4/SATA RAID w/ Rear 2 x 2.5-inch (w/ FPERC11)

NOTE: Follow the sequential order as shown in the table to remove the cables, to install the cables follow the reverse sequential order.

Table 74. 10 x 2.5-inch SAS4/SATA RAID (w/ FPERC11)

| Order | From | To |
|-------|---|---|
| 1 | SIG_PWR_1 (system board power connector) | BP_PWR_1 (backplane power connector) |
| 2 | SL1 (signal connector on system board) | CTRL_DST_PA1 (front PERC) |
| 3 | CTRL_SRC_SB1 (front PERC) | BP_DST_SB1 (backplane signal connector) & R_BP_DST_SA1 (rear backplane) |
| 4 | MB_SIG_PWR_0 (system board power connector) | R_BP_PWR_1 (rear backplane power connector) |

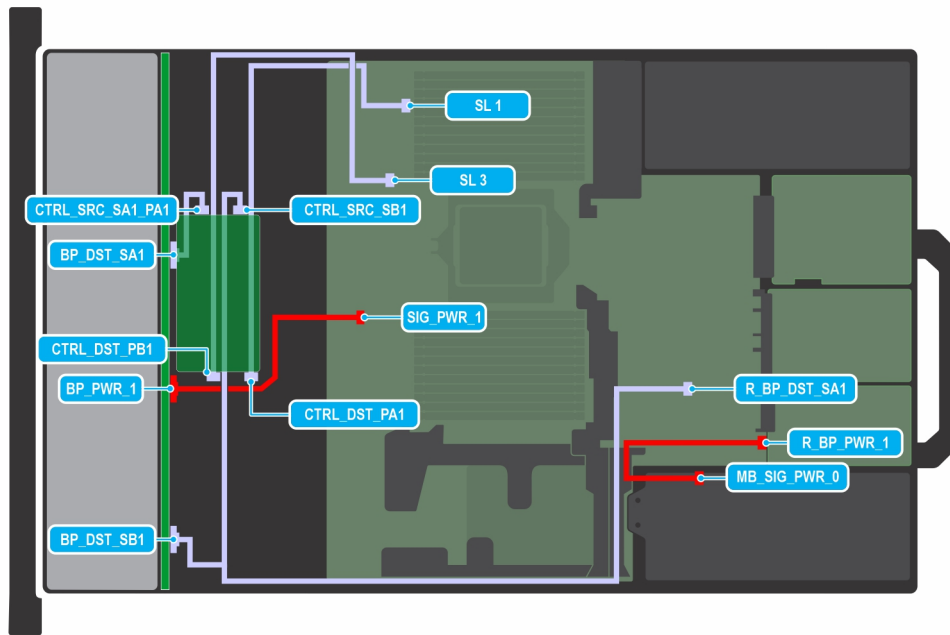

Figure 58. 10 x 2.5-inch SAS4/SATA RAID w/ Rear 2 x 2.5-inch (w/ FPERC12)

NOTE: Follow the sequential order as shown in the table to remove the cables, to install the cables follow the reverse sequential order.

Table 75. 10 x 2.5-inch SAS4/SATA RAID (w/ FPERC12)

| Order | From | To |
|-------|---|---|
| 1 | SIG_PWR_1 (system board power connector) | BP_PWR_1 (backplane power connector) |
| 2 | MB_SIG_PWR_0 (system board power connector) | R_BP_PWR_1 (rear backplane power connector) |
| 3 | SL1 (signal connector on system board) | CTRL_DST_PA1 (front PERC) |
| 4 | SL3 (signal connector on system board) | CTRL_DST_PB1 (front PERC) |
| 5 | CTRL_SRC_SB1 (front PERC) | BP_DST_SB1 (backplane signal connector) & R_BP_DST_SA1 (rear backplane) |
| 6 | CTRL_SRC_SA1_PA1 (front PERC) | BP_DST_SA1 (backplane signal connector) |

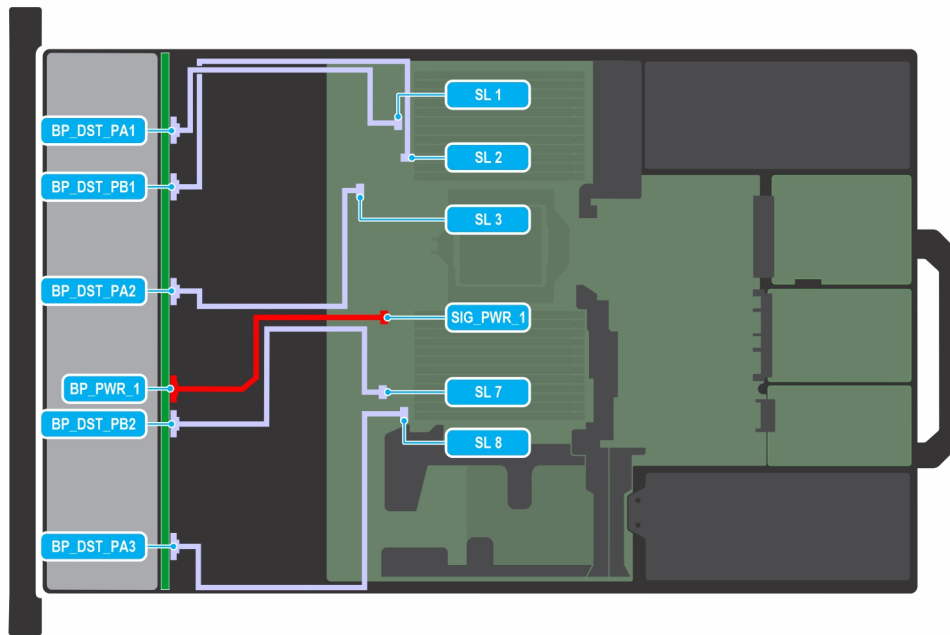

Figure 59. 10 x U.2 G4

NOTE: Follow the sequential order as shown in the table to remove the cables, to install the cables follow the reverse sequential order.

Table 76. 10 x U.2 G4

| Order | From | To |
|-------|--|---|
| 1 | SIG_PWR_1 (system board power connector) | BP_PWR_1 (backplane power connector) |
| 2 | SL1 (signal connector on system board) | CTRL_DST_PA1 (front PERC) |
| 3 | SL2 (signal connector on system board) | CTRL_DST_PB1 (front PERC) |
| 4 | SL3 (signal connector on system board) | CTRL_DST_PA2 (front PERC) |
| 5 | SL7 (signal connector on system board) | BP_DST_PB2 (backplane signal connector) |
| 6 | SL8 (signal connector on system board) | BP_DST_PA3 (backplane signal connector) |

PERC module

This is a service technician replaceable part only.

Removing the front mounting front PERC module

Prerequisites

1. Follow the safety guidelines listed in the [Safety instructions](#).
2. Follow the procedure listed in the [Before working inside your system](#).
3. [Remove the drive backplane cover](#).
4. If installed, [remove the air shroud](#).
5. Disconnect the SAS cable from PERC, observe the cable routing.

Steps

1. Disconnect the PERC cable.

2. Using a Phillips #2 screwdriver, loosen the captive screws on the front PERC module.
3. Pull the front PERC module to disengage from the connector on the drive backplane.

NOTE: The numbers on the image do not depict the exact steps. The numbers are for representation of sequence.

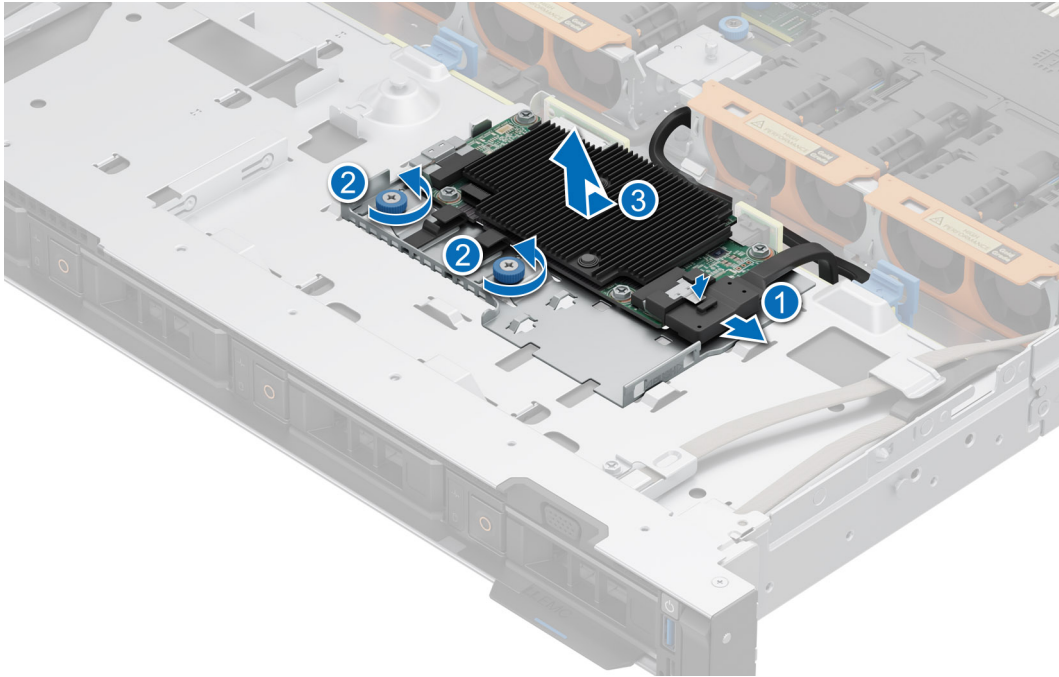

Figure 60. Removing the front mounting front PERC module

Next steps

1. Replace the front mounting front PERC module.

Installing the front mounting front PERC module

Prerequisites

1. Follow the safety guidelines listed in the [Safety instructions](#).
2. Follow the procedure listed in the [Before working inside your system](#).
3. [Remove the drive backplane cover](#).
4. If installed, [remove the air shroud](#).
5. Route the cable properly to prevent the cable from being pinched or crimped.

Steps

1. Align the front PERC module at an angle until the tray touches the slot in the system.
2. Connect the PERC cable to the front PERC module.
3. Using a Phillips #2 screwdriver, tighten the captive screws on the front PERC module.
4. Press the front PERC module connector with the connector on the drive backplane until firmly seated.

NOTE: The numbers on the image do not depict the exact steps. The numbers are for representation of sequence.

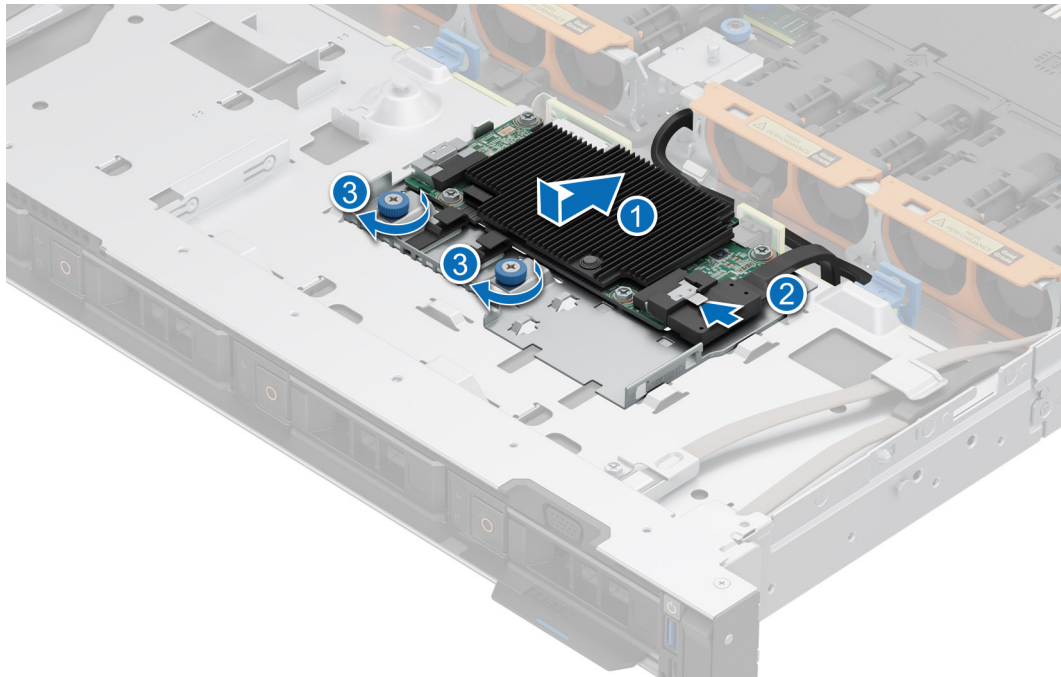

Figure 61. Installing the front mounting front PERC module

Next steps

1. Reconnect the required cables.
2. If removed, [replace the air shroud](#).
3. [Install the drive backplane cover](#).
4. Follow the procedure listed in [After working inside your system](#).

Removing the rear mounting front PERC module

Prerequisites

1. Follow the safety guidelines listed in the [Safety instructions](#).
2. Follow the procedure listed in the [Before working inside your system](#).
3. [Remove the drive backplane cover](#).
4. If installed, [remove the air shroud](#).
5. [Remove the drive backplane](#).
6. Disconnect all the cables, observe the cable routing.

Steps

1. Using a Phillips #2 screwdriver, loosen the captive screws on the front PERC module.
2. Slide the front PERC module to disengage from the connector on the drive backplane.

NOTE: The numbers on the image do not depict the exact steps. The numbers are for representation of sequence.

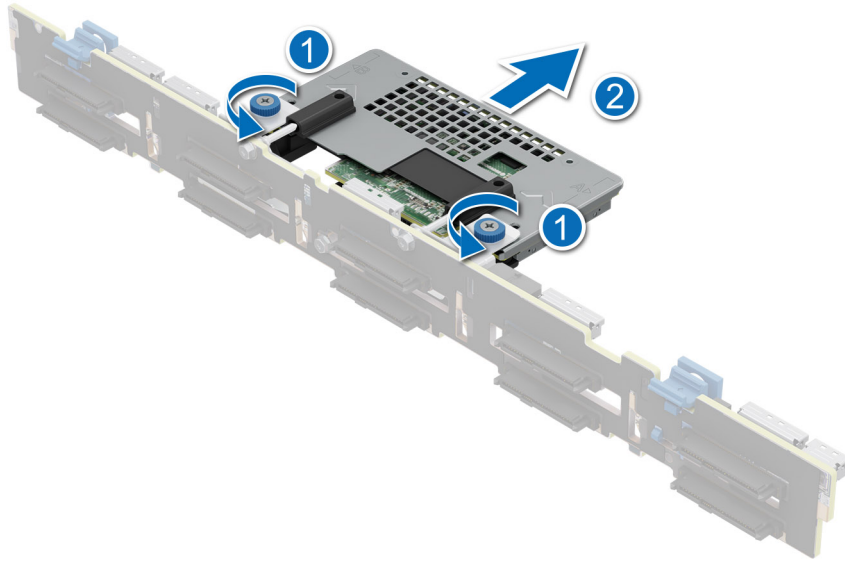

Figure 62. Removing the rear mounting front PERC module

3. Using a Phillips #2 screwdriver, remove the three screws securing the front PERC bracket to the drive backplane.
4. Lift the front PERC bracket away from the drive backplane.

Next steps

1. [Replace the rear mounting front PERC module.](#)

Installing the rear mounting front PERC module

Prerequisites

1. Follow the safety guidelines listed in the [Safety instructions](#).
2. Follow the procedure listed in the [Before working inside your system](#).
3. [Remove the drive backplane cover](#).
4. If installed, [remove the air shroud](#).
5. [Remove the drive backplane](#).
6. Route the cable properly to prevent the cable from being pinched or crimped.

Steps

1. Align the slots on the front PERC bracket with the holes on the drive backplane.
2. Using a Phillips #2 screwdriver, replace the three screws to secure the front PERC bracket to the drive backplane.
3. Align the connectors on the front PERC module with the connectors on the drive backplane.
4. Slide the front PERC module until the module is connected to the drive backplane.
5. Using a Phillips #2 screwdriver, tighten the captive screws on the front PERC module.

NOTE: The numbers on the image do not depict the exact steps. The numbers are for representation of sequence.

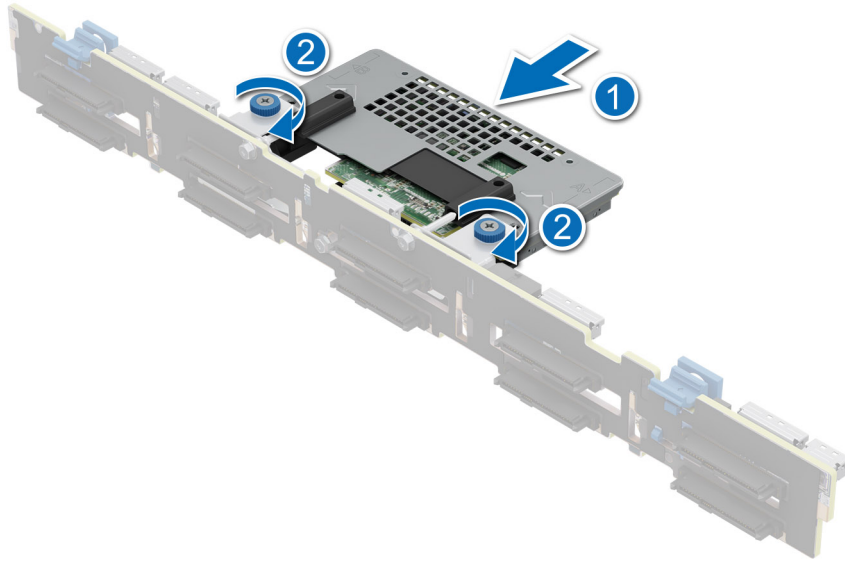

Figure 63. Installing the rear mounting front PERC module

Next steps

1. [Install the drive backplane.](#)
2. If removed, [install the air shroud.](#)
3. [Install the drive backplane cover.](#)
4. Follow the procedure listed in [After working inside your system.](#)

System memory

System memory guidelines

The PowerEdgeR6615 system supports DDR5 registered DIMMs (RDIMMs).

Your system memory is organized into twelve channels per processor (one memory socket per channel), 12 memory sockets per processor and 12 memory sockets per system.

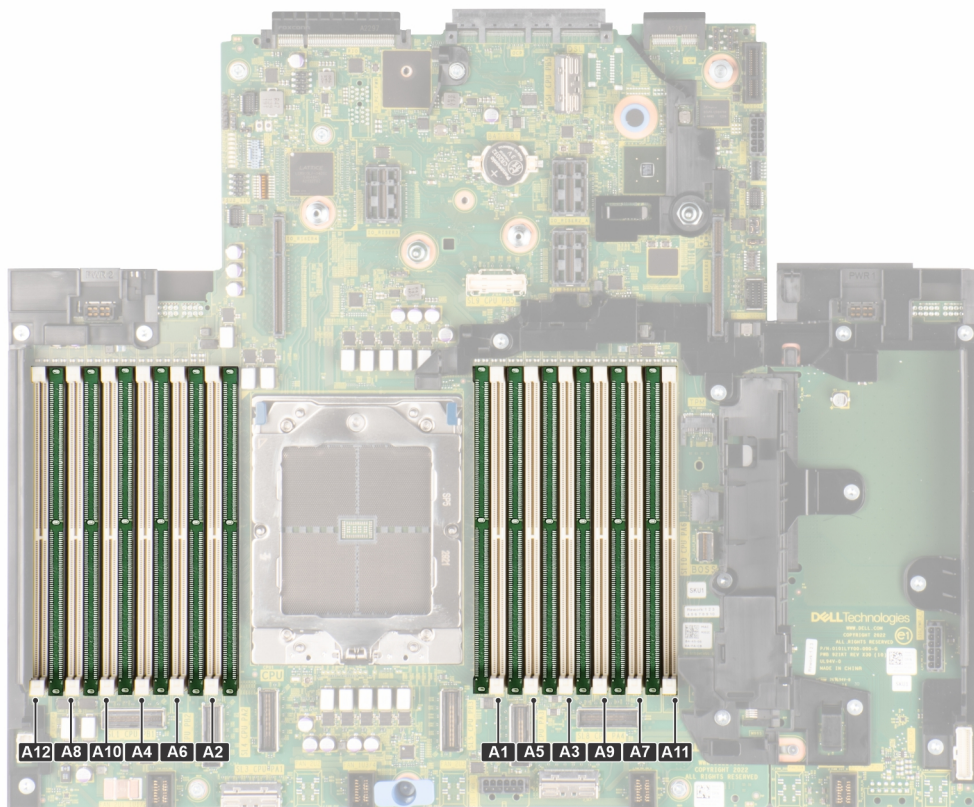

Figure 64. Memory channels

Memory channels are organized as follows:

Table 77. Memory channels

| Processor | Channel A | Channel B | Channel C | Channel D | Channel E | Channel F | Channel G | Channel H | Channel I | Channel J | Channel K | Channel L |
|-------------|-----------|-----------|-----------|-----------|-----------|-----------|-----------|-----------|-----------|-----------|-----------|-----------|
| Processor 1 | Slot A1 | Slot A5 | Slot A3 | Slot A9 | Slot A7 | Slot A11 | Slot A2 | Slot A6 | Slot A4 | Slot A10 | Slot A8 | Slot A12 |

Table 78. Supported memory matrix

| DIMM type | Rank | Capacity | DIMM rated voltage and speed | Operating Speed |
|------------|------|--------------|------------------------------|--------------------------|
| | | | | 1 DIMM per channel (DPC) |
| DDR5 RDIMM | 1 R | 16 GB | DDR5 (1.1 V), 4800 MT/s | 4800 MT/s |
| | 2 R | 32 GB, 64 GB | DDR5 (1.1 V), 4800 MT/s | 4800 MT/s |

NOTE: DDR4 memory is not supported in the R6615.

General memory module installation guidelines

To ensure optimal performance of your system, observe the following general guidelines when configuring your system memory. If your system's memory configurations fail to observe these guidelines, your system might not boot, stop responding during memory configuration, or operate with reduced memory. This section provides information on the memory population rules for single or dual processor system.

The memory bus operate at speeds up to 4800 MT/s depending on the following factors:

- System profile selected (for example, Performance Optimized, or Custom [can be run at high speed or lower])
- Maximum supported DIMM speed of the processors
- Maximum supported speed of the DIMMs

NOTE: MT/s indicates DIMM speed in MegaTransfers per second.

The system supports Flexible Memory Configuration, enabling the system to be configured and run in any valid chipset architectural configuration. The following are the recommended guidelines for installing memory modules:

- All DIMMs must be RDIMM DDR5 with the same capacity and width.
 - Mixing different DIMM capacities is not supported.
 - Mixing module types within a memory channel is not supported. All DIMMs populated must be RDIMM.
 - Mixing different widths (x4 & x8) is not supported.
- Populate memory module sockets only if a processor is installed.
 - For single-processor systems, sockets A1 to A12 are available.
 - A minimum of 1 DIMM must be populated for each installed CPU.
 - In Optimizer Mode, the DRAM controllers operate independently in the 64-bit mode and provide optimized memory performance.

Table 79. Memory population rules

| Processor | Configuration | Memory population | Memory population information |
|------------------|--|---|--|
| Single processor | Optimizer (Independent channel) population order | A{1}, A{2}, A{3}, A{4}, A{5}, A{6}, A{7}, A{8}, A{9}, A{10}, A{11}, A{12} | Odd amount of DIMMs per processor allowed. |

- Populate the sockets with white release tabs.
- Persistent memory will not be supported on Genoa based platforms.
- For best performance, populate all memory channels equally (12 DIMMs per CPU) using identical DIMMs.
- Unbalanced or odd memory configurations result in a performance loss and the system may not identify the memory modules being installed, so always populate memory channels identically with equal DIMMs for best performance.

- Minimum recommended configuration is to populate four equal memory modules per processor.

Removing a memory module

Prerequisites

1. Follow the safety guidelines listed in the [Safety instructions](#).
2. Follow the procedure listed in the [Before working inside your system](#).
3. [Remove the air shroud](#).

⚠ WARNING: The memory modules are hot to touch for some time after the system has been powered off. Allow the memory modules to cool before handling them.

Steps

1. Locate the appropriate memory module socket.

⚠ CAUTION: Handle each memory module only by the card edges, ensuring not to touch the middle of the memory module or metallic contacts.

2. To release the memory module from the socket, simultaneously press the ejectors on both ends of the memory module socket.
3. Lift the memory module away from the system.

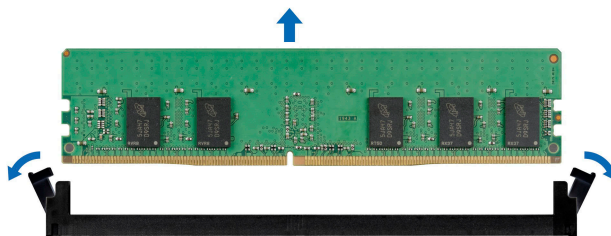

Figure 65. Removing a memory module

Next steps

1. [Replace the memory module](#). If you are removing a memory module permanently, install a memory module blank.

i NOTE: The procedure to install a memory module blank is similar to the procedure to install a memory module.

i NOTE: To ensure proper system cooling, memory module blanks must be installed in any memory socket that is not occupied. The memory module blanks compatible with R6615 are DDR5 gray color blanks. Remove the memory module blanks only if you intend to install memory modules in these sockets.

Installing a memory module

Prerequisites

1. Follow the safety guidelines listed in the [Safety instructions](#).
2. Follow the procedure listed in the [Before working inside your system](#).
3. [Remove the air shroud](#).

Steps

1. Locate the appropriate memory module socket.

⚠ CAUTION: Handle each memory module only by the card edges, ensuring not to touch the middle of the memory module or metallic contacts.

2. If a memory module is installed in the socket, remove it.

NOTE: Ensure the socket ejector latches are fully open, before installing the memory module.

- Align the edge connector of the memory module with the alignment key of the memory module socket, and insert the memory module in the socket.

CAUTION: To prevent damage to the memory module or the memory module socket during installation, do not bend or flex the memory module; insert both ends of the memory module simultaneously.

NOTE: The memory module socket has an alignment key that enables you to install the memory module in the socket in only one orientation.

CAUTION: Do not apply pressure at the center of the memory module; apply pressure at both ends of the memory module evenly.

- Press the memory module with your thumbs until the ejectors firmly click into place.

When the memory module is properly seated in the socket, the levers on the memory module socket align with the levers on the other sockets that have memory modules installed.

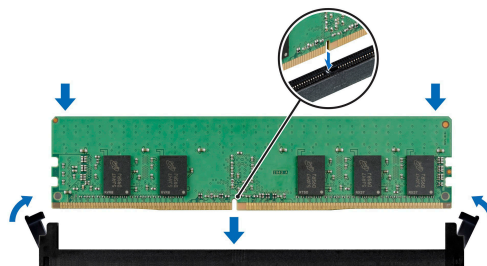

Figure 66. Installing a memory module

Next steps

- Install the air shroud.
- Follow the procedure listed in [After working inside your system](#).
- Press F2 to enter System Setup, and check the **System Memory** setting. The **System Memory Size** indicates the installed memory.
- If the **System Memory Size** is incorrect, one or more of the memory modules may not be installed properly. Ensure that the memory modules are firmly seated in their sockets.
- Run the system memory test in the system diagnostics.

Processor and heat sink

Removing a heat sink

Prerequisites

- Follow the safety guidelines listed in the [Safety instructions](#).
- Follow the procedure listed in the [Before working inside your system](#).
- [Remove the air shroud](#).

NOTE: The heat sink and processor are too hot to touch for some time after the system has been powered down. Allow the heat sink and processor to cool down before handling them.

Steps

- Using a Torx #T20 screwdriver, fully loosen the captive screw all the way before moving to the next screw (on one-screw-at-a-time basis).

NOTE: Follow the screw sequence defined on the heat sink label. Disassembly order: 6, 5, 4, 3, 2, 1

NOTE: The captive screw numbers are marked on the heat sink.

2. Lift the heat sink from the system.

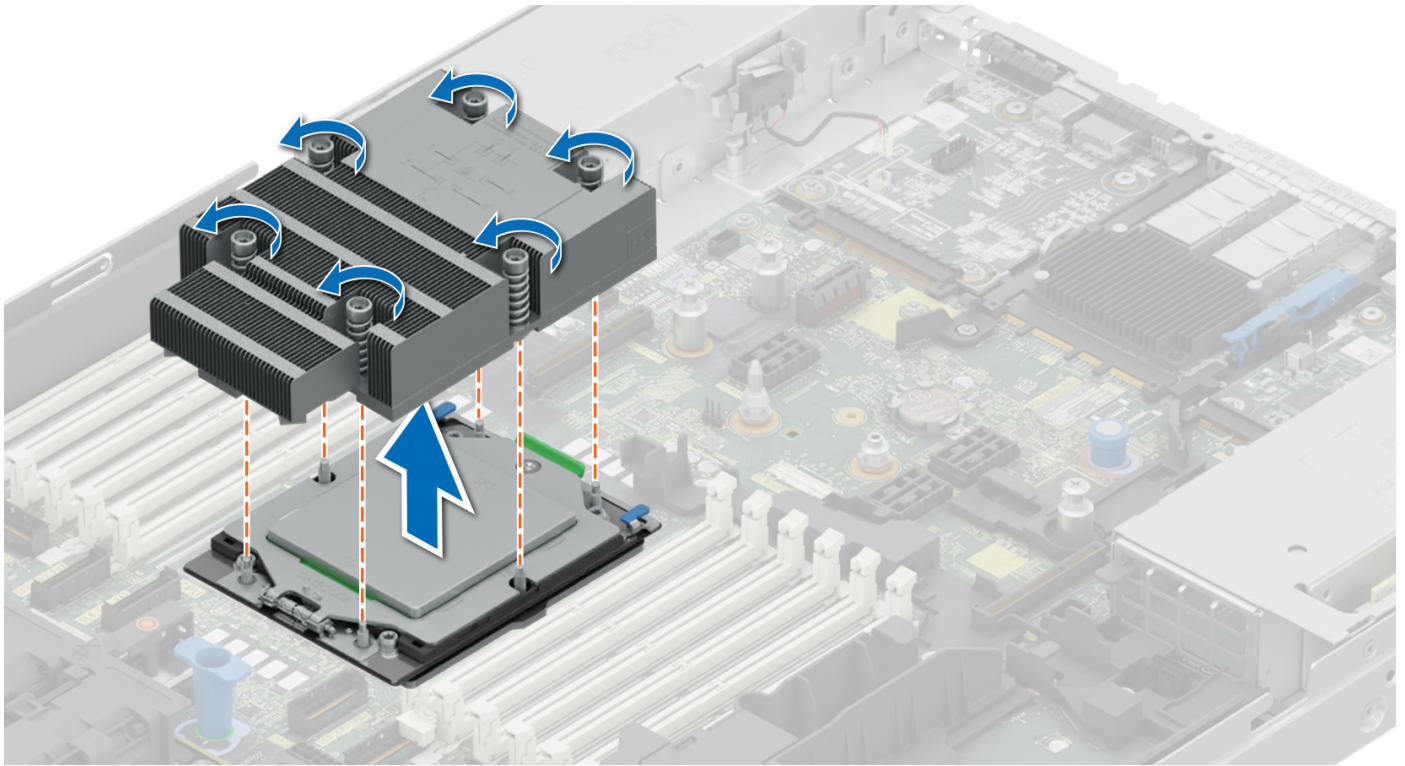

Figure 67. Removing a heat sink

Next steps

If you are removing a faulty heat sink, replace the heat sink, if not, [remove the processor](#).

Removing the Direct Liquid Cooling module

Prerequisites

1. Follow the safety guidelines listed in the [Safety instructions](#).
2. Follow the procedure listed in the [Before working inside your system](#).
3. [Remove the air shroud](#).
4. [Remove the expansion card riser](#).

WARNING: The Direct liquid cooling (DLC) module and processor are too hot to touch for some time after the system has been powered off. Allow the liquid cooling module and processor to cool down before handling them.

NOTE: Rear I/O (RIO) board is different for the system with DLC module.

Steps

1. Using a Phillips #2 screw driver, loosen the captive screw on the DLC ring holder.
2. Tilt the DLC ring holder to loosen the DLC tubes.
3. Disconnect the DLC leak detection cable from the LC RIO board.
4. Remove the DLC tubes from the clip and LC RIO board.
5. Slightly lift the DLC tubes surrounding the DIMM slots.

6. Using a Torx #T20 screwdriver, fully loosen the captive screw all the way before moving to the next screw (on one-screw-at-a-time basis).

NOTE: Follow the screw sequence defined on the heat sink label. Disassembly order: 6, 5, 4, 3, 2, 1.

NOTE: The captive screw numbers are marked on the heat sink.

NOTE: Ensure the anti-tilt wires on the DLC module are in locked position when loosening the captive screws.

7. Set the anti-tilt wires on the DLC module to the unlock position and lift the DLC module from the system.

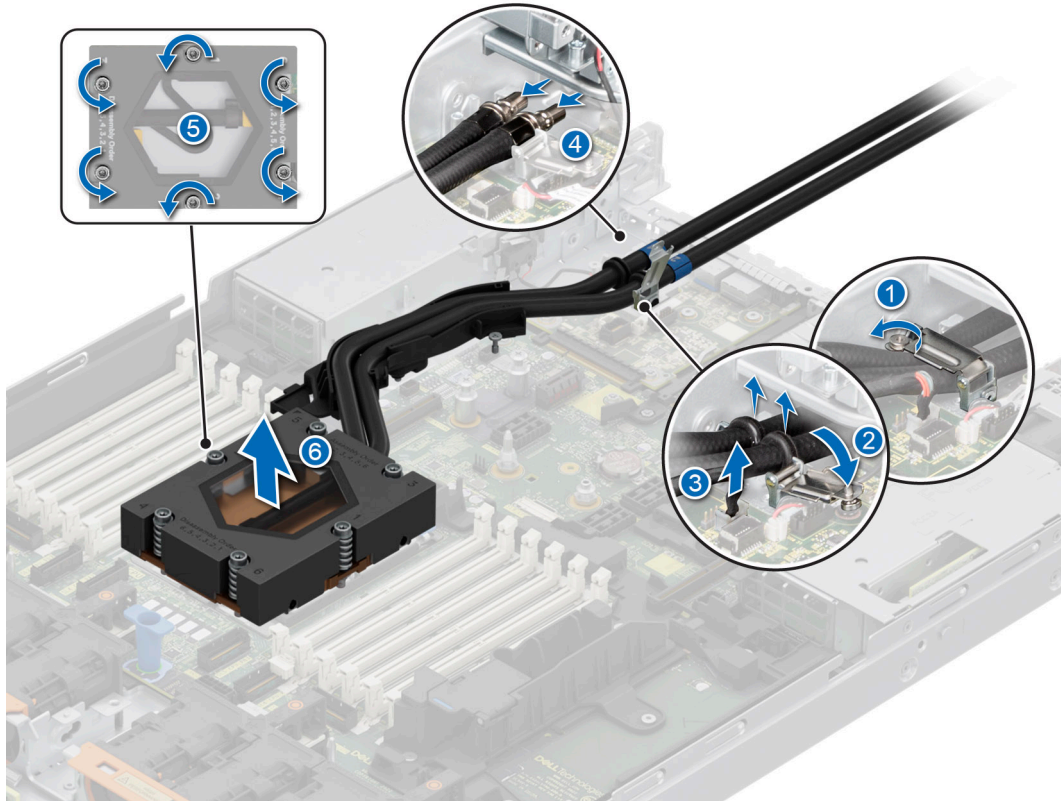

Figure 68. Removing the DLC module

Next steps

1. If you are removing a faulty liquid cooling module, [replace the Direct Liquid Cooling module](#), else [remove the processor](#).

Removing the AMD processor

Prerequisites

WARNING: The heat sink may be hot to touch for some time after the system has been powered off. Allow the heat sink to cool before removing it.

1. Follow the safety guidelines listed in the [Safety instructions](#).
2. Follow the procedure listed in the [Before working inside your system](#).
3. [Remove the air shroud](#).
4. [Remove the heat sink](#) or [Remove the liquid cooling module](#).

CAUTION: You may find the CMOS battery loss or CMOS checksum error displayed during the first instance of powering on the system after the processor or system board replacement which is expected. To fix this, simply go to setup option to configure the system settings.

Steps

1. Using a Torx #T20 screwdriver, loosen the middle screw to release the retention frame. Hold and lift the retention frame upwards and rotate it slightly past the vertical position(105 degrees).

i **NOTE:** The spring loading will keep the retention frame at its "open" position.

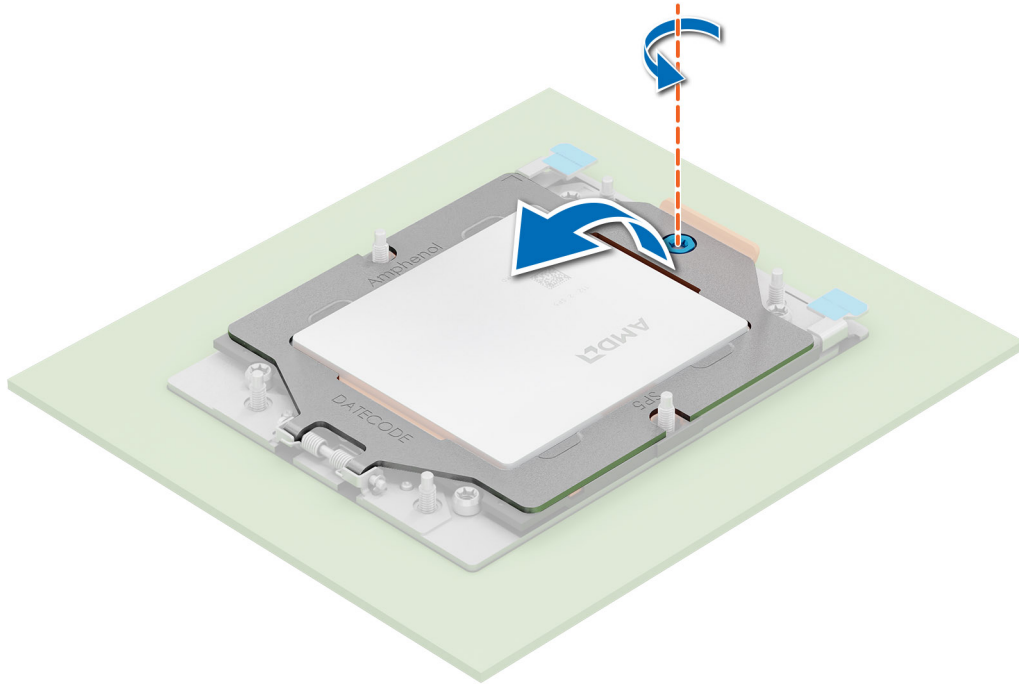

Figure 69. Removing screws on the retention frame

2. Release the processor socket rail frame by holding both blue tabs to lift the blue latches.

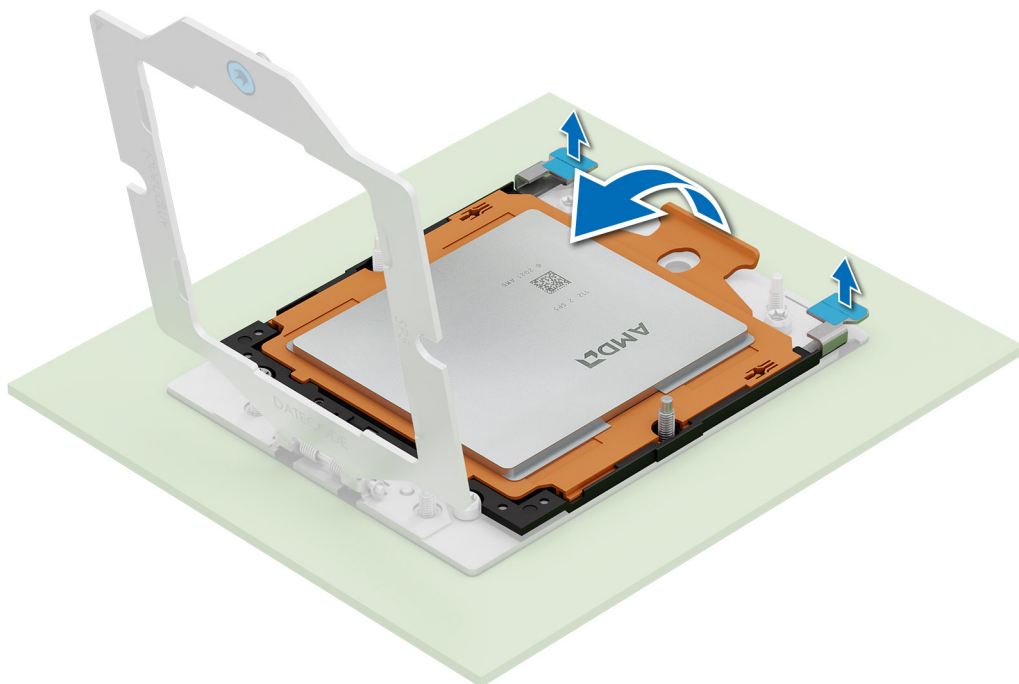

Figure 70. Lifting the rail frame

3. Holding the handle on the carrier frame, slide the tray out of the rail frame.

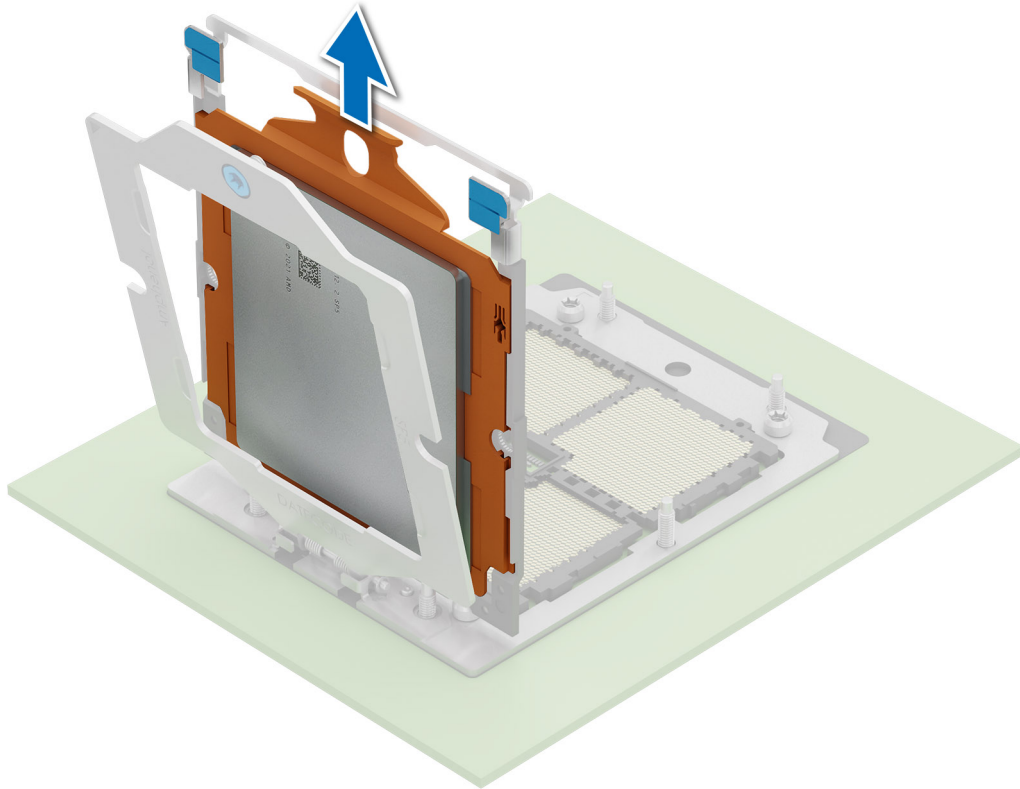

Figure 71. Removing the carrier frame

Next steps

Replace the AMD processor.

Installing the AMD processor

Prerequisites

1. Follow the safety guidelines listed in the [Safety instructions](#).
2. Follow the procedure listed in the [Before working inside your system](#).

Steps

1. Holding the handle of the carrier frame, slide the tray into the processor socket rail frame until firmly seated.

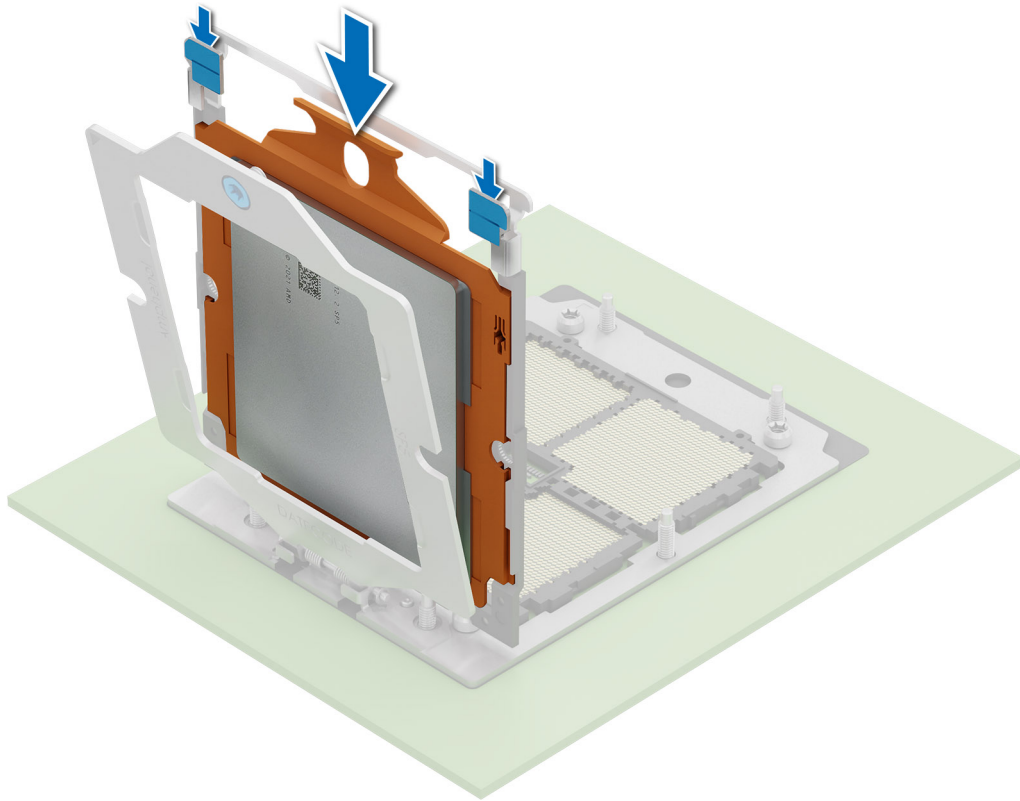

Figure 72. Placing the carrier frame into the rail frame

2. Holding both of blue tabs to push the rail frame down until the blue latches lock into place.

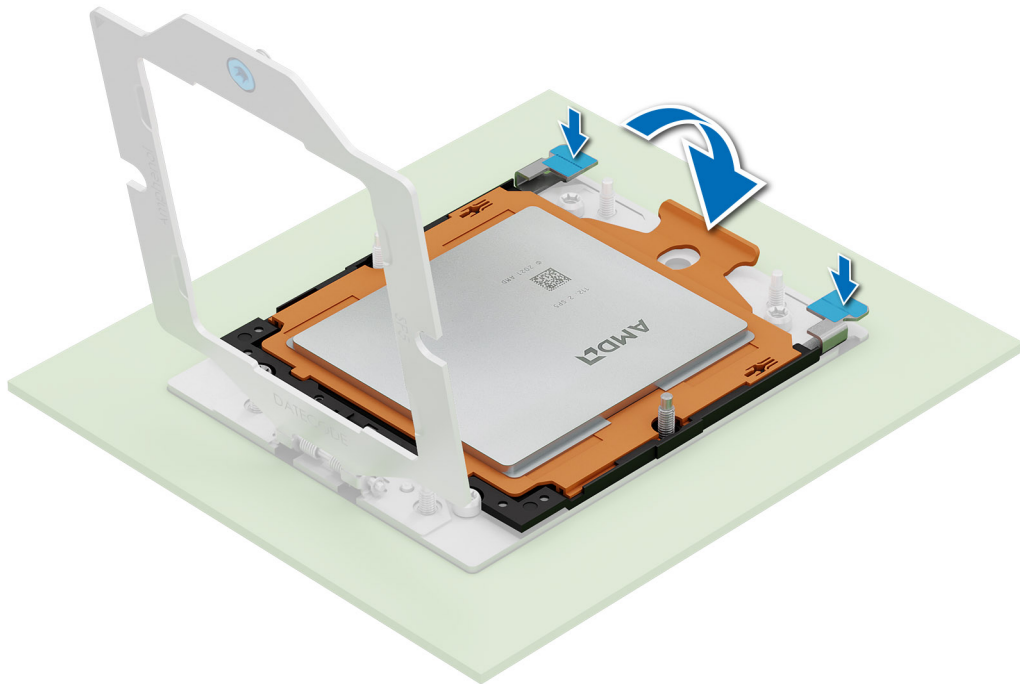

Figure 73. Closing the rail frame

3. Secure the retention frame by holding down the retention frame with one hand while using the other hand to operate the screw driver to engage and tighten screw.

NOTE: Press the retention frame while tightening the screws to avoid tilting of the processor cover out of the processor socket.

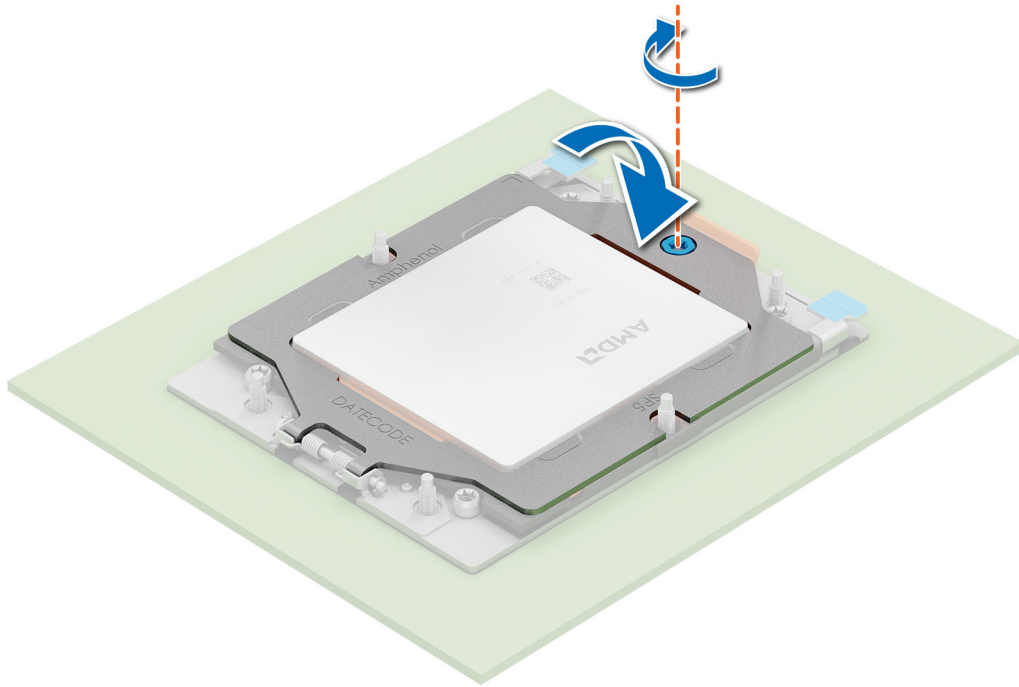

Figure 74. Securing the retention frame

Next steps

1. [Install the heat sink](#) or [Install the liquid cooling module](#).
2. [Install the air shroud](#).
3. Follow the procedure listed in [After working inside your system](#).

Installing the heat sink

Prerequisites

Never remove the heat sink from a processor unless you intend to replace the processor or system board. The heat sink is necessary to maintain proper thermal conditions.

1. Follow the safety guidelines listed in the [Safety instructions](#).
2. Follow the procedure listed in the [Before working inside your system](#).
3. [Remove the air shroud](#).
4. If installed, remove the processor dust cover.

Steps

1. If you are using an existing heat sink, remove the thermal grease on the heat sink by using a clean lint-free cloth.

NOTE: For a new heat sink, the thermal paste is pre-applied to the heat sink. Remove the protective cover, and install the heat sink.

2. Use the thermal grease syringe included with your processor kit to apply the grease in a thin spiral on the top of the processor.

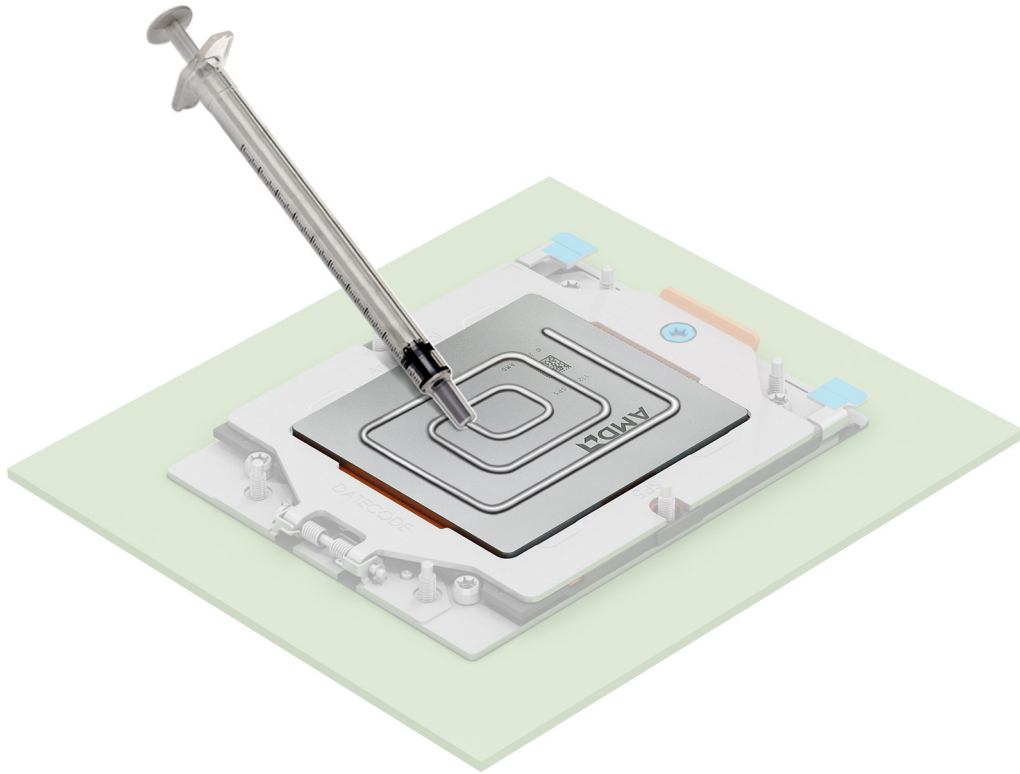

Figure 75. Applying thermal grease

CAUTION: Applying too much thermal grease can result in excess grease coming in contact with and contaminating the processor socket.

NOTE: The thermal grease syringe is intended for single use only. Dispose of the syringe after you use it.

NOTE: Refer to the airflow direction on heat sink label as visual hint of heat sink install orientation.

3. Align the screws on the heat sink with the standoff screws on the system board.
4. Using a Torx #T20 screwdriver, fully tighten the captive screw all the way down before moving to the next screw (on one-screw-at-a-time basis).

NOTE: Follow the screw sequence defined on heat sink label. Assembly order: 1, 2, 3, 4, 5, 6

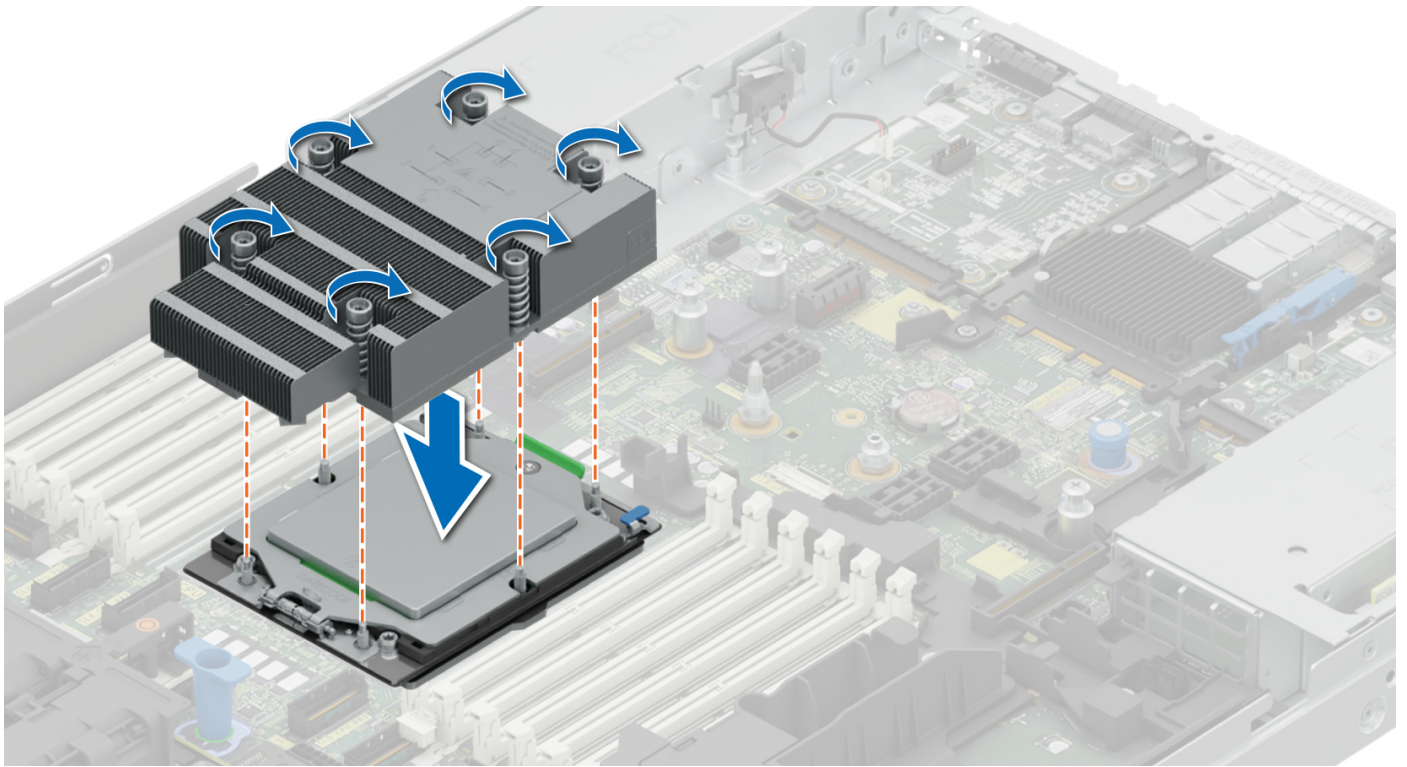

Figure 76. Installing the heat sink

Next steps

1. [Install the air shroud.](#)
2. Follow the procedure listed in the [After working inside your system.](#)

Installing the Direct Liquid Cooling module

Prerequisites

Never uninstall the Direct Liquid Cooling (DLC) module from a processor unless you intend to replace the processor or system board. The DLC module is necessary to maintain proper thermal conditions.

1. Follow the safety guidelines listed in the [Safety instructions.](#)
2. Follow the procedure listed in the [Before working inside your system.](#)
3. [Remove the air shroud.](#)
4. [Remove the expansion card riser.](#)
5. If installed, remove the processor dust cover.

i **NOTE:** Ensure anti-tilt wires on the DLC module are in the unlocked position.

i **NOTE:** The recommended maximum operating pressure is 15 psi (diverter opens at 15 psi).

Steps

1. Align the DLC module with the standoff screws on the system board. Place the module on the processor slot and set all the anti-tilt wires to locked position (outward position).

i **NOTE:** Ensure that the DLC tubes and liquid cooling leak detection cable are placed towards the rear of the system.

2. Using a Torx #T20 screwdriver, fully tighten the captive screw all the way down before moving to the next screw (on one-screw-at-a-time basis).

NOTE: Follow the screw sequence defined on heat sink label. Assembly order: 1, 2, 3, 4, 5, 6.

3. Route the DLC tubes to the rear of the system through the RIO board.

NOTE: Leak detection cable must be placed first into the clip (underneath the cooling tubes), and then place tube 2 and tube 1 into the clip to ensure that cable does not interfere with the PCIe risers.

NOTE: Follow the number labels on the DLC tubes and ring holders (1,2).

4. Connect the DLC leak detection cable to the connector on RIO.

5. Align the rubber ring on the tubes with the ring holder.

6. Tilt the DLC ring holder and using a Phillips #2 screwdriver, tighten the captive screw on the DLC ring holder to secure it in place.

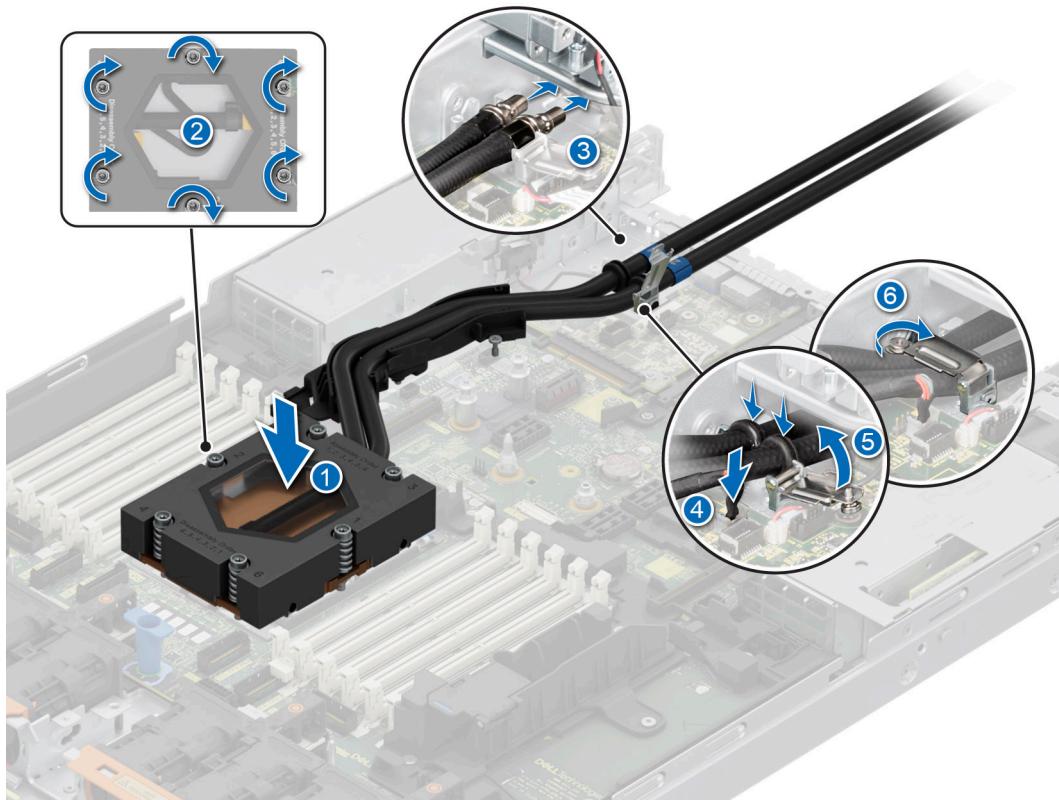

Figure 77. Installing the DLC module

Next steps

1. Install the expansion card riser.
2. Install the air shroud.
3. Follow the procedure listed in the [After working inside your system](#).

Expansion cards and expansion card risers

NOTE: A system event entry is logged in the iDRAC Lifecycle Controller if an expansion card riser is not supported or missing. It does not prevent your system from turning on. However, if a F1/F2 pause occurs with an error message, see [Troubleshooting expansion cards](#) section in the *Dell EMC PowerEdge Servers Troubleshooting Guide* at www.dell.com/poweredgemanuals.

Expansion card installation guidelines

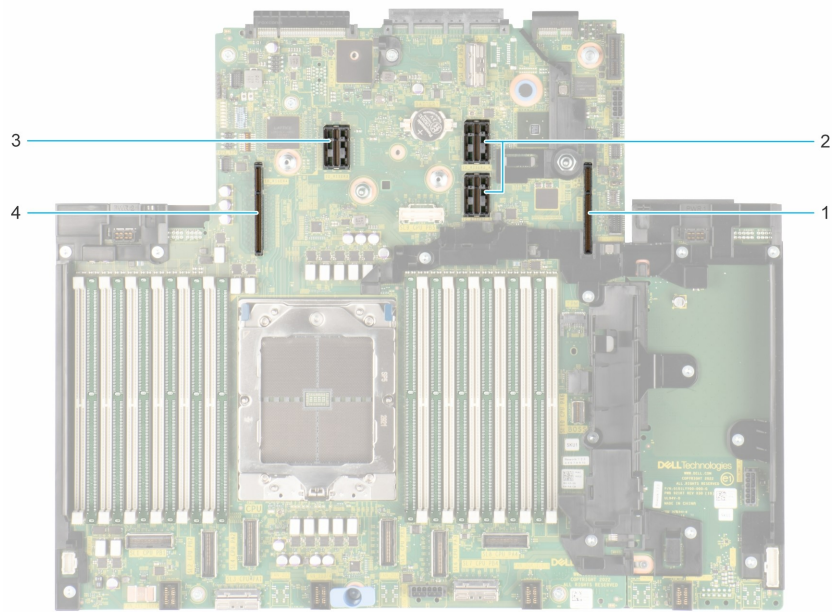

Figure 78. Expansion card riser slot connectors

1. Riser 1
2. Riser 2
3. Riser 3
4. Riser 4

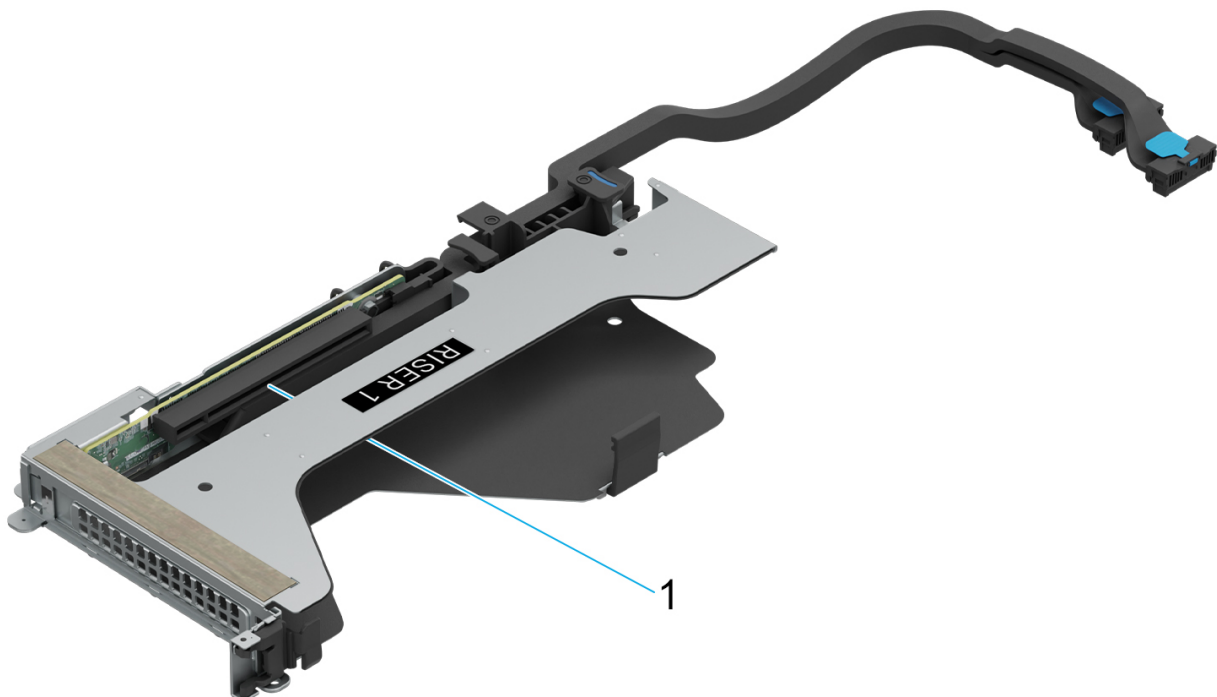

Figure 79. Riser 1Q

1. Slot 1

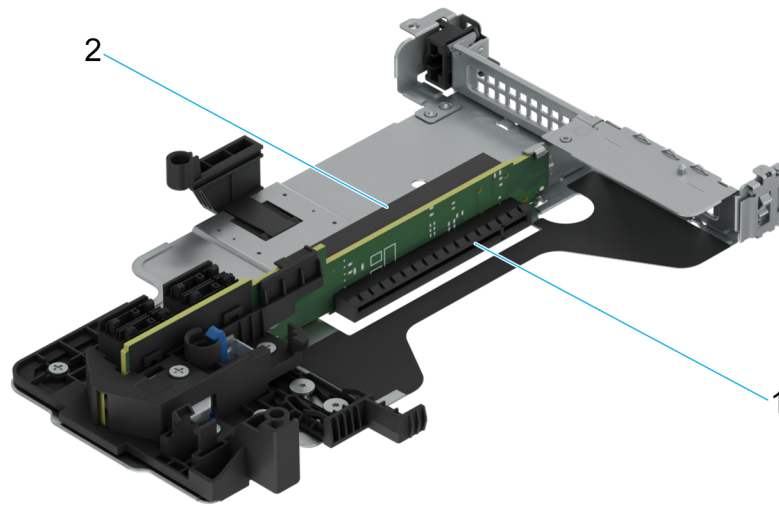

Figure 80. Riser 2A

- 1. Slot 1
- 2. Slot 2

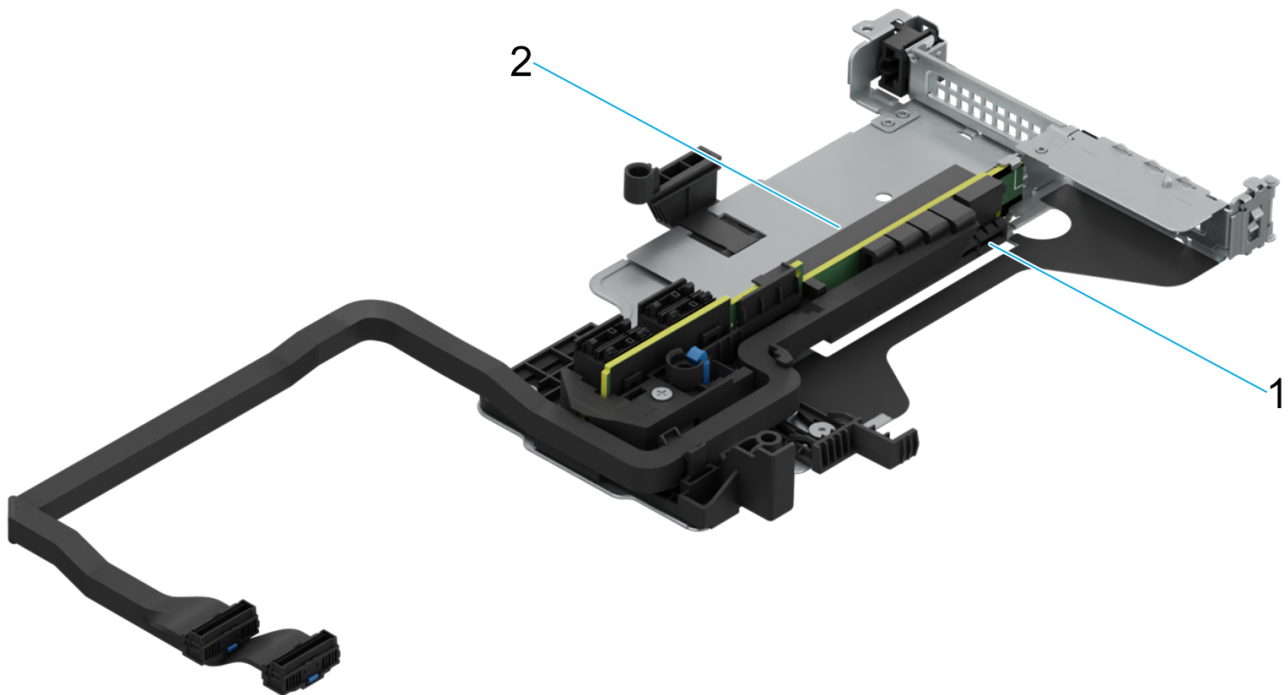

Figure 81. Riser 2T

- 1. Slot 1
- 2. Slot 2

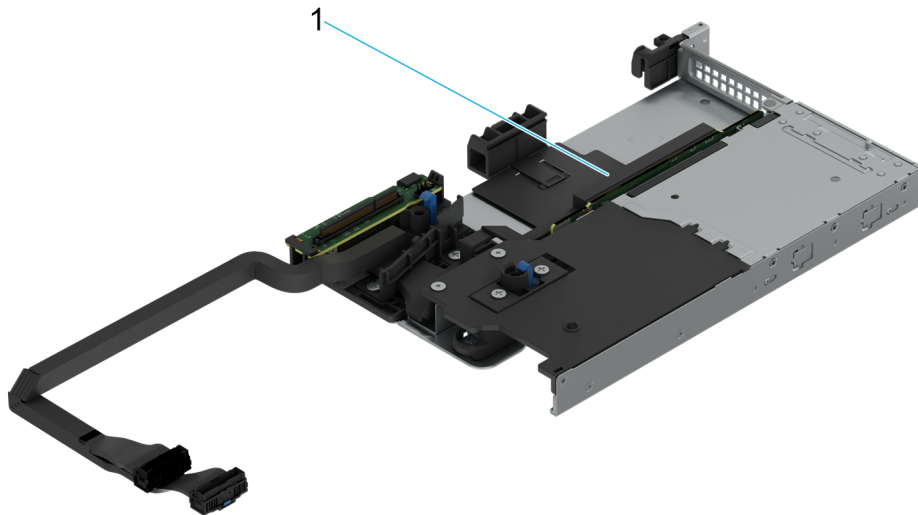

Figure 82. Riser 2U

1. Slot 1

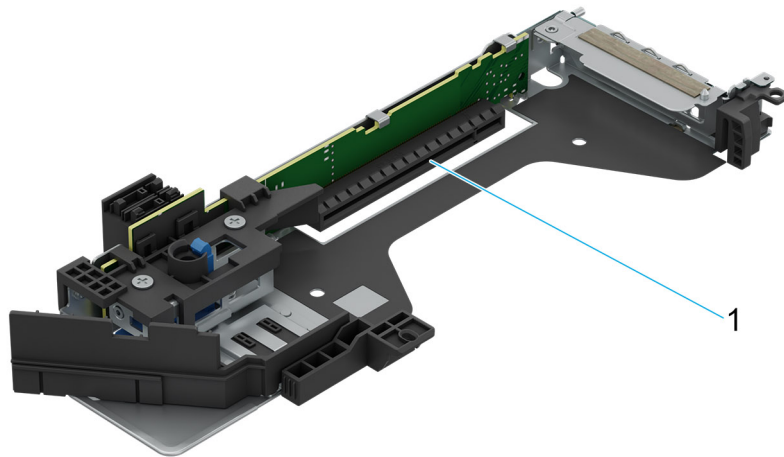

Figure 83. Riser 3A

1. Slot 3

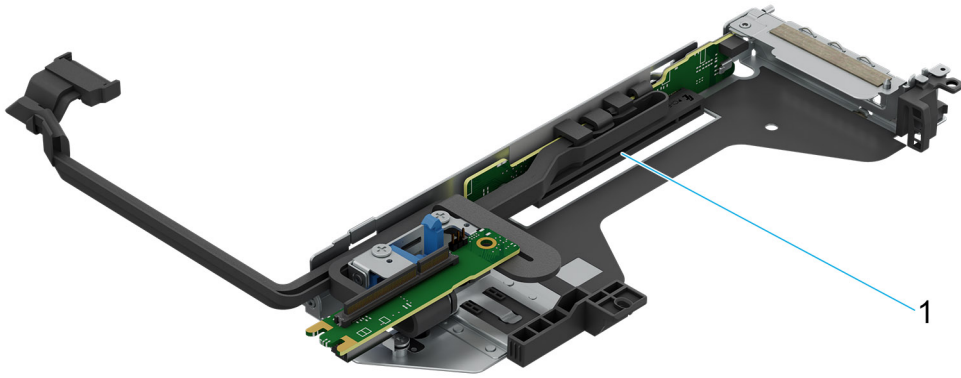

Figure 84. Riser 3P

1. Slot 3

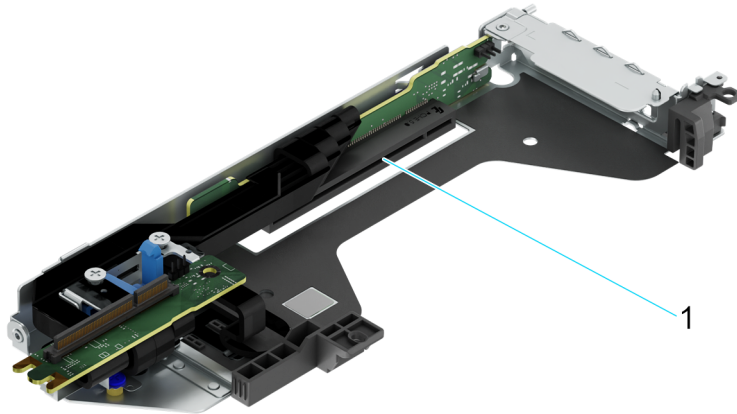

Figure 85. Riser 3S

1. Slot 3

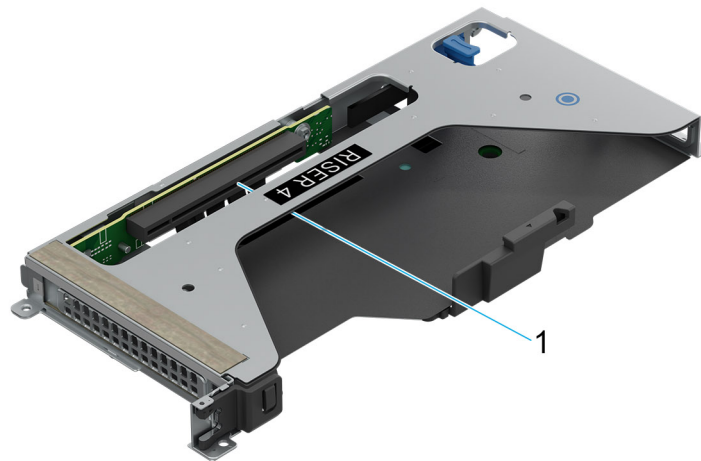

Figure 86. Riser 4P

1. Slot 2

NOTE: The expansion-card slots are not hot-swappable.

The following table provides guidelines for installing expansion cards to ensure proper cooling and mechanical fit. The expansion cards with the highest priority should be installed first using the slot priority indicated. All the other expansion cards should be installed in the card priority and slot priority order.

Table 80. Expansion card riser configurations

| PCIe slot | With Regular shroud | With GPU shroud | R1Q | R2A | R2T | R2U | R3A | R3P | R3S | R4P |
|-----------|---------------------------|---------------------------|------------|-----------|------------|------------|------------|------------|------------|------------|
| Slot 1 | Full height - Half length | Full height - Full length | x16 (Gen5) | x8 (Gen4) | x16 (Gen5) | x16 (Gen5) | - | - | - | - |
| Slot 2 | Full height - Half length | Full height - Full length | - | x8 (Gen4) | x16 (Gen4) | - | - | - | - | x16 (Gen5) |
| Slot 3 | Low profile - Half length | Low profile - Half length | - | - | - | - | x16 (Gen4) | x16 (Gen5) | x16 (Gen5) | - |

Table 81. PCIe Riser Configurations

| Configuration number | RSR Configuration | No. of CPUs | PERC type supported | Rear Storage Possible | x8 CPU 1 Slot1 LP | x8 CPU 2 Slot2 LP | x16 CPU 1 Slot1 LP | x16 CPU 1 Slot2 LP | x16 CPU 1 Slot3 LP | x16 CPU 1 Slot1 FH | x16 CPU 1 Slot2 FH |
|----------------------|-------------------|-------------|---------------------|-----------------------|-------------------|-------------------|--------------------|--------------------|--------------------|--------------------|--------------------|
| 0 | No RSR | 1 | Front PERC | No | 0 | 0 | 0 | 0 | 0 | 0 | 0 |
| 1 | R2A+R3A | 1 | Front PERC | No | 1 (Gen 4) | 1 (Gen 4) | 0 | 0 | 1 (Gen 4) | 0 | 0 |
| 2 | R2T+R3P | 1 | Front PERC | No | 0 | 0 | 1 (Gen 5) | 1 (Gen 4) | 1 (Gen 5) | 0 | 0 |
| 3 | R1Q+R4P | 1 | Front PERC | No | 0 | 0 | 0 | 0 | 0 | 1 (Gen 5) | 1 (Gen 5) |
| 4 | R2T | 1 | Front PERC | No | 0 | 0 | 1 (Gen 5) | 1 (Gen 4) | 0 | 0 | 0 |

Table 81. PCIe Riser Configurations (continued)

| Configuratio n number | RSR Config uratio n | No. of CPUs | PERC type suppo rted | Rear Storage Possible | x8 CPU 1 Slot1 LP | x8 CPU 2 Slot2 LP | x16 CPU 1 Slot1 LP | x16 CPU 1 Slot2 LP | x16 CPU 1 Slot3 LP | x16 CPU 1 Slot1 FH | x16 CPU 1 Slot2 FH |
|--------------------------|---------------------------|----------------|-------------------------------|-----------------------------|----------------------|-------------------------|--------------------------|--------------------------|--------------------------|--------------------------|--------------------------|
| 5 | R3P | 1 | Front PERC | Yes | 0 | 0 | 0 | 0 | 1 (Gen 5) | 0 | 0 |
| 6 | R2A | 1 | Front PERC | No | 1 (Gen 4) | 1 (Gen 4) | 0 | 0 | 0 | 0 | 0 |
| 7 | R2U+R 3A | 1 | Front PERC | Yes | 0 | 0 | 1 (Gen 5) | 0 | 1 (Gen 5) | 0 | 0 |
| 8 | R2T+R 3A | 1 | Front PERC | Yes | 0 | 0 | 1 (Gen 5) | 1 (Gen 4) | 1 (Gen 4) | 0 | 0 |

i **NOTE:** The expansion-card slots are not hot-swappable.

The following table provides guidelines for installing expansion cards to ensure proper cooling and mechanical fit. The expansion cards with the highest priority should be installed first using the slot priority indicated. All the other expansion cards should be installed in the card priority and slot priority order.

Table 82. Config0. No RSR

| CARD TYPE | SLOT PRIORITY | MAXIMUM NUMBER OF CARDS |
|----------------------|-----------------|-------------------------|
| FOXCONN (Front PERC) | Integrated slot | 1 |
| FOXCONN (Front PERC) | Integrated slot | 1 |
| Inventec (LOM Card) | Integrated slot | 1 |
| Inventec (LOM Card) | Integrated slot | 1 |
| Intel (OCP: 25Gb) | Integrated slot | 1 |
| Intel (OCP: 25Gb) | Integrated slot | 1 |
| Mellanox (OCP: 25Gb) | Integrated slot | 1 |
| Broadcom (OCP: 25Gb) | Integrated slot | 1 |
| Broadcom (OCP: 25Gb) | Integrated slot | 1 |
| Broadcom (OCP: 25Gb) | Integrated slot | 1 |
| Broadcom (OCP: 25Gb) | Integrated slot | 1 |
| Broadcom (OCP: 25Gb) | Integrated slot | 1 |
| Broadcom (OCP: 10Gb) | Integrated slot | 1 |
| Broadcom (OCP: 10Gb) | Integrated slot | 1 |
| Intel (OCP: 10Gb) | Integrated slot | 1 |
| Intel (OCP: 10Gb) | Integrated slot | 1 |
| Broadcom (OCP: 10Gb) | Integrated slot | 1 |
| Broadcom (OCP: 1Gb) | Integrated slot | 1 |
| Intel (OCP: 1Gb) | Integrated slot | 1 |
| Broadcom (OCP: 1Gb) | Integrated slot | 1 |
| FOXCONN (BOSS) | Integrated slot | 1 |
| FOXCONN (BOSS) | Integrated slot | 1 |

Table 83. Config1. R2A+R3A

| CARD TYPE | SLOT PRIORITY | MAXIMUM NUMBER OF CARDS |
|----------------------------|----------------------|--------------------------------|
| Inventec (1U Serial board) | 3 | 1 |
| FOXCONN (Front PERC) | Integrated slot | 1 |
| FOXCONN (Front PERC) | Integrated slot | 1 |
| FOXCONN (Front PERC) | Integrated slot | 1 |
| FOXCONN (Front PERC) | Integrated slot | 1 |
| FOXCONN (Front PERC) | Integrated slot | 1 |
| FOXCONN (Front PERC) | Integrated slot | 1 |
| FOXCONN (Front PERC) | Integrated slot | 1 |
| FOXCONN (External Adapter) | 1,2,3 | 3 |
| (External Adapter) | 1,2,3 | 3 |
| (External Adapter) | 1,2,3 | 3 |
| Inventec (LOM Card) | Integrated slot | 1 |
| Inventec (LOM Card) | Integrated slot | 1 |
| Mellanox (NIC: 400Gb) | 3 | 1 |
| Broadcom (NIC: 100Gb) | 3 | 1 |
| Intel (NIC: 100Gb) | 1,2,3 | 3 |
| Mellanox (NIC: 100Gb) | 3 | 1 |
| Intel (NIC: 25Gb) | 1,2,3 | 3 |
| Mellanox (NIC: 25Gb) | 3 | 1 |
| Broadcom (NIC: 25Gb) | 1,2,3 | 3 |
| Broadcom (HBA: FC64) | 1,2,3 | 3 |
| Broadcom (HBA: FC32) | 1,2,3 | 3 |
| Broadcom (HBA: FC32) | 1,2,3 | 3 |
| Marvell (HBA: FC32) | 1,2,3 | 3 |
| Marvell (HBA: FC32) | 1,2,3 | 3 |
| Broadcom (NIC: 10Gb) | 1,2,3 | 3 |
| Broadcom (NIC: 10Gb) | 1,2,3 | 3 |
| Intel (NIC: 10Gb) | 1,2,3 | 3 |
| Intel (NIC: 10Gb) | 1,2,3 | 3 |
| Intel (NIC: 1Gb) | 1,2,3 | 3 |
| Broadcom (NIC: 1Gb) | 1,2,3 | 3 |
| Mellanox (NIC: NDR200) | 3 | 1 |
| Mellanox (NIC: HDRV) | 3 | 1 |
| Intel (OCP: 25Gb) | Integrated slot | 1 |
| Intel (OCP: 25Gb) | Integrated slot | 1 |
| Mellanox (OCP: 25Gb) | Integrated slot | 1 |
| Broadcom (OCP: 25Gb) | Integrated slot | 1 |

Table 83. Config1. R2A+R3A (continued)

| CARD TYPE | SLOT PRIORITY | MAXIMUM NUMBER OF CARDS |
|----------------------|-----------------|-------------------------|
| Broadcom (OCP: 25Gb) | Integrated slot | 1 |
| Broadcom (OCP: 25Gb) | Integrated slot | 1 |
| Broadcom (OCP: 25Gb) | Integrated slot | 1 |
| Broadcom (OCP: 10Gb) | Integrated slot | 1 |
| Broadcom (OCP: 10Gb) | Integrated slot | 1 |
| Intel (OCP: 10Gb) | Integrated slot | 1 |
| Intel (OCP: 10Gb) | Integrated slot | 1 |
| Broadcom (OCP: 10Gb) | Integrated slot | 1 |
| Broadcom (OCP: 1Gb) | Integrated slot | 1 |
| Intel (OCP: 1Gb) | Integrated slot | 1 |
| Broadcom (OCP: 1Gb) | Integrated slot | 1 |
| FOXCONN (BOSS) | Integrated slot | 1 |
| FOXCONN (BOSS) | Integrated slot | 1 |

Table 84. Config2. R2T + R3P

| CARD TYPE | SLOT PRIORITY | MAXIMUM NUMBER OF CARDS |
|----------------------------|-----------------|-------------------------|
| Inventec (1U Serial board) | 3 | 1 |
| FOXCONN (Front PERC) | Integrated slot | 2 |
| FOXCONN (Front PERC) | Integrated slot | 2 |
| FOXCONN (Front PERC) | Integrated slot | 2 |
| FOXCONN (Front PERC) | Integrated slot | 1 |
| FOXCONN (Front PERC) | Integrated slot | 1 |
| FOXCONN (Front PERC) | Integrated slot | 1 |
| FOXCONN (Front PERC) | Integrated slot | 1 |
| FOXCONN (External Adapter) | 1,2,3 | 3 |
| (External Adapter) | 1,2,3 | 3 |
| (External Adapter) | 1,2,3 | 3 |
| Inventec (LOM Card) | Integrated slot | 1 |
| Inventec (LOM Card) | Integrated slot | 1 |
| Mellanox (NIC: 400Gb) | 1,2,3 | 3 |
| Broadcom (NIC: 100Gb) | 1,2,3 | 3 |
| Intel (NIC: 100Gb) | 1,2,3 | 3 |
| Mellanox (NIC: 100Gb) | 1,2,3 | 3 |
| Intel (NIC: 100Gb) | 1,2,3 | 3 |
| Intel (NIC: 25Gb) | 1,2,3 | 3 |
| Mellanox (NIC: 25Gb) | 1,2,3 | 3 |
| Broadcom (NIC: 25Gb) | 1,2,3 | 3 |
| Broadcom (HBA: FC64) | 1,2,3 | 3 |

Table 84. Config2. R2T + R3P (continued)

| CARD TYPE | SLOT PRIORITY | MAXIMUM NUMBER OF CARDS |
|------------------------|-----------------|-------------------------|
| Broadcom (HBA: FC32) | 1,2,3 | 3 |
| Broadcom (HBA: FC32) | 1,2,3 | 3 |
| Marvell (HBA: FC32) | 1,2,3 | 3 |
| Marvell (HBA: FC32) | 1,2,3 | 3 |
| Broadcom (NIC: 10Gb) | 1,2,3 | 3 |
| Broadcom (NIC: 10Gb) | 1,2,3 | 3 |
| Intel (NIC: 10Gb) | 1,2,3 | 3 |
| Intel (NIC: 10Gb) | 1,2,3 | 3 |
| Intel (NIC: 1Gb) | 1,2,3 | 3 |
| Broadcom (NIC: 1Gb) | 1,2,3 | 3 |
| Mellanox (NIC: NDR200) | 1,2,3 | 3 |
| Mellanox (NIC: HDRV) | 1,2,3 | 3 |
| Intel (OCP: 25Gb) | Integrated slot | 1 |
| Intel (OCP: 25Gb) | Integrated slot | 1 |
| Mellanox (OCP: 25Gb) | Integrated slot | 1 |
| Broadcom (OCP: 25Gb) | Integrated slot | 1 |
| Broadcom (OCP: 25Gb) | Integrated slot | 1 |
| Broadcom (OCP: 25Gb) | Integrated slot | 1 |
| Broadcom (OCP: 25Gb) | Integrated slot | 1 |
| Broadcom (OCP: 10Gb) | Integrated slot | 1 |
| Broadcom (OCP: 10Gb) | Integrated slot | 1 |
| Intel (OCP: 10Gb) | Integrated slot | 1 |
| Intel (OCP: 10Gb) | Integrated slot | 1 |
| Broadcom (OCP: 10Gb) | Integrated slot | 1 |
| Broadcom (OCP: 1Gb) | Integrated slot | 1 |
| Intel (OCP: 1Gb) | Integrated slot | 1 |
| Broadcom (OCP: 1Gb) | Integrated slot | 1 |
| FOXCONN (BOSS) | Integrated slot | 1 |
| FOXCONN (BOSS) | Integrated slot | 1 |

Table 85. Config3. R1Q + R4P

| CARD TYPE | SLOT PRIORITY | MAXIMUM NUMBER OF CARDS |
|----------------------|-----------------|-------------------------|
| Nvidia (GPU) | 1,2 | 2 |
| Nvidia (GPU) | 1,2 | 2 |
| FOXCONN (Front PERC) | Integrated slot | 2 |
| FOXCONN (Front PERC) | Integrated slot | 2 |
| FOXCONN (Front PERC) | Integrated slot | 2 |
| FOXCONN (Front PERC) | Integrated slot | 1 |

Table 85. Config3. R1Q + R4P (continued)

| CARD TYPE | SLOT PRIORITY | MAXIMUM NUMBER OF CARDS |
|-------------------------------------|----------------------|--------------------------------|
| FOXCONN (Front PERC) | Integrated slot | 1 |
| FOXCONN (Front PERC) | Integrated slot | 1 |
| FOXCONN (Front PERC) | Integrated slot | 1 |
| (External Adapter) | 1,2 | 2 |
| (External Adapter) | 1,2 | 2 |
| Inventec (LOM Card) | Integrated slot | 1 |
| Inventec (LOM Card) | Integrated slot | 1 |
| Inventec (Paige Card) | Integrated slot | 1 |
| Inventec (Melody Card) | Integrated slot | 1 |
| Pensando (SmartNIC: 100Gb) | 1,2 | 2 |
| Intel (SmartNIC: 100Gb) | 1,2 | 2 |
| Nvidia (Mellanox) (SmartNIC: 100Gb) | 1,2 | 2 |
| Pensando (SmartNIC: 25Gb) | 1,2 | 2 |
| Nvidia (MLNX) (SmartNIC: 25Gb) | 1,2 | 2 |
| Intel (SmartNIC: 25Gb) | 1,2 | 2 |
| Mellanox (NIC: 400Gb) | 1,2 | 2 |
| Broadcom (NIC: 100Gb) | 1,2 | 2 |
| Intel (NIC: 100Gb) | 1,2 | 2 |
| Mellanox (NIC: 100Gb) | 1,2 | 2 |
| Intel (NIC: 100Gb) | 1,2 | 2 |
| Intel (NIC: 25Gb) | 1,2 | 2 |
| Intel (NIC: 25Gb) | 1,2 | 2 |
| Mellanox (NIC: 25Gb) | 1,2 | 2 |
| Broadcom (NIC: 25Gb) | 1,2 | 2 |
| Broadcom (NIC: 25Gb) | 2,1 | 2 |
| Broadcom (HBA: FC64) | 2,1 | 2 |
| Broadcom (HBA: FC32) | 1,2 | 2 |
| Broadcom (HBA: FC32) | 1,2 | 2 |
| Marvell (HBA: FC32) | 1,2 | 2 |
| Marvell (HBA: FC32) | 1,2 | 2 |
| Broadcom (NIC: 10Gb) | 1,2 | 2 |
| Broadcom (NIC: 10Gb) | 1,2 | 2 |
| Intel (NIC: 10Gb) | 1,2 | 2 |
| Intel (NIC: 10Gb) | 1,2 | 2 |
| Intel (NIC: 1Gb) | 1,2 | 2 |
| Broadcom (NIC: 1Gb) | 1,2 | 2 |
| Mellanox (NIC: NDR200) | 1,2 | 2 |

Table 85. Config3. R1Q + R4P (continued)

| CARD TYPE | SLOT PRIORITY | MAXIMUM NUMBER OF CARDS |
|----------------------|-----------------|-------------------------|
| Mellanox (NIC: HDRV) | 1,2 | 2 |
| Intel (OCP: 25Gb) | Integrated slot | 1 |
| Intel (OCP: 25Gb) | Integrated slot | 1 |
| Mellanox (OCP: 25Gb) | Integrated slot | 1 |
| Broadcom (OCP: 25Gb) | Integrated slot | 1 |
| Broadcom (OCP: 25Gb) | Integrated slot | 1 |
| Broadcom (OCP: 25Gb) | Integrated slot | 1 |
| Broadcom (OCP: 25Gb) | Integrated slot | 1 |
| Broadcom (OCP: 10Gb) | Integrated slot | 1 |
| Broadcom (OCP: 10Gb) | Integrated slot | 1 |
| Intel (OCP: 10Gb) | Integrated slot | 1 |
| Intel (OCP: 10Gb) | Integrated slot | 1 |
| Broadcom (OCP: 10Gb) | Integrated slot | 1 |
| Broadcom (OCP: 1Gb) | Integrated slot | 1 |
| Intel (OCP: 1Gb) | Integrated slot | 1 |
| Broadcom (OCP: 1Gb) | Integrated slot | 1 |
| FOXCONN (BOSS) | Integrated slot | 1 |
| FOXCONN (BOSS) | Integrated slot | 1 |

Table 86. Config4. R2T

| CARD TYPE | SLOT PRIORITY | MAXIMUM NUMBER OF CARDS |
|-----------------------|-----------------|-------------------------|
| FOXCONN (Front PERC) | Integrated slot | 1 |
| FOXCONN (Front PERC) | Integrated slot | 1 |
| FOXCONN (Front PERC) | Integrated slot | 1 |
| (External Adapter) | 1,2 | 2 |
| (External Adapter) | 1,2 | 2 |
| Inventec (LOM Card) | Integrated slot | 1 |
| Inventec (LOM Card) | Integrated slot | 1 |
| Mellanox (NIC: 400Gb) | 1,2 | 2 |
| Broadcom (NIC: 100Gb) | 1,2 | 2 |
| Intel (NIC: 100Gb) | 1,2 | 2 |
| Mellanox (NIC: 100Gb) | 1,2 | 2 |
| Intel (NIC: 100Gb) | 1,2 | 2 |
| Intel (NIC: 25Gb) | 1,2 | 2 |
| Mellanox (NIC: 25Gb) | 1,2 | 2 |
| Broadcom (NIC: 25Gb) | 1,2 | 2 |
| Broadcom (HBA: FC64) | 1,2 | 2 |
| Broadcom (HBA: FC32) | 1,2 | 2 |

Table 86. Config4. R2T (continued)

| CARD TYPE | SLOT PRIORITY | MAXIMUM NUMBER OF CARDS |
|------------------------|-----------------|-------------------------|
| Broadcom (HBA: FC32) | 1,2 | 2 |
| Marvell (HBA: FC32) | 1,2 | 2 |
| Marvell (HBA: FC32) | 1,2 | 2 |
| Broadcom (NIC: 10Gb) | 1,2 | 2 |
| Broadcom (NIC: 10Gb) | 1,2 | 2 |
| Intel (NIC: 10Gb) | 1,2 | 2 |
| Intel (NIC: 10Gb) | 1,2 | 2 |
| Intel (NIC: 1Gb) | 1,2 | 2 |
| Broadcom (NIC: 1Gb) | 1,2 | 2 |
| Mellanox (NIC: NDR200) | 1,2 | 2 |
| Mellanox (NIC: HDRV) | 1,2 | 2 |
| Intel (OCP: 25Gb) | Integrated slot | 1 |
| Intel (OCP: 25Gb) | Integrated slot | 1 |
| Mellanox (OCP: 25Gb) | Integrated slot | 1 |
| Broadcom (OCP: 25Gb) | Integrated slot | 1 |
| Broadcom (OCP: 25Gb) | Integrated slot | 1 |
| Broadcom (OCP: 25Gb) | Integrated slot | 1 |
| Broadcom (OCP: 25Gb) | Integrated slot | 1 |
| Broadcom (OCP: 10Gb) | Integrated slot | 1 |
| Broadcom (OCP: 10Gb) | Integrated slot | 1 |
| Intel (OCP: 10Gb) | Integrated slot | 1 |
| Intel (OCP: 10Gb) | Integrated slot | 1 |
| Broadcom (OCP: 10Gb) | Integrated slot | 1 |
| Broadcom (OCP: 1Gb) | Integrated slot | 1 |
| Intel (OCP: 1Gb) | Integrated slot | 1 |
| Broadcom (OCP: 1Gb) | Integrated slot | 1 |
| FOXCONN (BOSS) | Integrated slot | 1 |
| FOXCONN (BOSS) | Integrated slot | 1 |

Table 87. Config5. R3P

| CARD TYPE | SLOT PRIORITY | MAXIMUM NUMBER OF CARDS |
|----------------------------|-----------------|-------------------------|
| Inventec (1U Serial board) | 3 | 1 |
| FOXCONN (Front PERC) | Integrated slot | 1 |
| FOXCONN (Front PERC) | Integrated slot | 1 |
| FOXCONN (Front PERC) | Integrated slot | 1 |
| FOXCONN (Front PERC) | Integrated slot | 1 |
| FOXCONN (Front PERC) | Integrated slot | 1 |
| (External Adapter) | 3 | 1 |

Table 87. Config5. R3P (continued)

| CARD TYPE | SLOT PRIORITY | MAXIMUM NUMBER OF CARDS |
|------------------------|----------------------|--------------------------------|
| (External Adapter) | 3 | 1 |
| Inventec (LOM Card) | Integrated slot | 1 |
| Inventec (LOM Card) | Integrated slot | 1 |
| Mellanox (NIC: 400Gb) | 3 | 1 |
| Broadcom (NIC: 100Gb) | 3 | 1 |
| Intel (NIC: 100Gb) | 3 | 1 |
| Mellanox (NIC: 100Gb) | 3 | 1 |
| Intel (NIC: 100Gb) | 3 | 1 |
| Intel (NIC: 25Gb) | 3 | 1 |
| Mellanox (NIC: 25Gb) | 3 | 1 |
| Broadcom (NIC: 25Gb) | 3 | 1 |
| Broadcom (HBA: FC64) | 3 | 1 |
| Broadcom (HBA: FC32) | 3 | 1 |
| Broadcom (HBA: FC32) | 3 | 1 |
| Marvell (HBA: FC32) | 3 | 1 |
| Marvell (HBA: FC32) | 3 | 1 |
| Broadcom (NIC: 10Gb) | 3 | 1 |
| Broadcom (NIC: 10Gb) | 3 | 1 |
| Intel (NIC: 10Gb) | 3 | 1 |
| Intel (NIC: 10Gb) | 3 | 1 |
| Intel (NIC: 1Gb) | 3 | 1 |
| Broadcom (NIC: 1Gb) | 3 | 1 |
| Mellanox (NIC: NDR200) | 3 | 1 |
| Mellanox (NIC: HDRV) | 3 | 1 |
| Intel (OCP: 25Gb) | Integrated slot | 1 |
| Intel (OCP: 25Gb) | Integrated slot | 1 |
| Mellanox (OCP: 25Gb) | Integrated slot | 1 |
| Broadcom (OCP: 25Gb) | Integrated slot | 1 |
| Broadcom (OCP: 25Gb) | Integrated slot | 1 |
| Broadcom (OCP: 25Gb) | Integrated slot | 1 |
| Broadcom (OCP: 25Gb) | Integrated slot | 1 |
| Broadcom (OCP: 10Gb) | Integrated slot | 1 |
| Broadcom (OCP: 10Gb) | Integrated slot | 1 |
| Intel (OCP: 10Gb) | Integrated slot | 1 |
| Intel (OCP: 10Gb) | Integrated slot | 1 |
| Broadcom (OCP: 10Gb) | Integrated slot | 1 |
| Broadcom (OCP: 1Gb) | Integrated slot | 1 |

Table 87. Config5. R3P (continued)

| CARD TYPE | SLOT PRIORITY | MAXIMUM NUMBER OF CARDS |
|---------------------|-----------------|-------------------------|
| Intel (OCP: 1Gb) | Integrated slot | 1 |
| Broadcom (OCP: 1Gb) | Integrated slot | 1 |
| FOXCONN (BOSS) | Integrated slot | 1 |
| FOXCONN (BOSS) | Integrated slot | 1 |

Table 88. Config6. R2A

| CARD TYPE | SLOT PRIORITY | MAXIMUM NUMBER OF CARDS |
|----------------------|-----------------|-------------------------|
| FOXCONN (Front PERC) | Integrated slot | 1 |
| FOXCONN (Front PERC) | Integrated slot | 1 |
| (External Adapter) | 1,2 | 2 |
| (External Adapter) | 1,2 | 2 |
| Inventec (LOM Card) | Integrated slot | 1 |
| Inventec (LOM Card) | Integrated slot | 1 |
| Intel (NIC: 100Gb) | 1,2 | 2 |
| Intel (NIC: 25Gb) | 1,2 | 2 |
| Broadcom (NIC: 25Gb) | 1,2 | 2 |
| Broadcom (HBA: FC64) | 1,2 | 2 |
| Broadcom (HBA: FC32) | 1,2 | 2 |
| Broadcom (HBA: FC32) | 1,2 | 2 |
| Marvell (HBA: FC32) | 1,2 | 2 |
| Marvell (HBA: FC32) | 1,2 | 2 |
| Broadcom (NIC: 10Gb) | 1,2 | 2 |
| Broadcom (NIC: 10Gb) | 1,2 | 2 |
| Intel (NIC: 10Gb) | 1,2 | 2 |
| Intel (NIC: 10Gb) | 1,2 | 2 |
| Intel (NIC: 1Gb) | 1,2 | 2 |
| Broadcom (NIC: 1Gb) | 1,2 | 2 |
| Intel (OCP: 25Gb) | Integrated slot | 1 |
| Intel (OCP: 25Gb) | Integrated slot | 1 |
| Mellanox (OCP: 25Gb) | Integrated slot | 1 |
| Broadcom (OCP: 25Gb) | Integrated slot | 1 |
| Broadcom (OCP: 25Gb) | Integrated slot | 1 |
| Broadcom (OCP: 25Gb) | Integrated slot | 1 |
| Broadcom (OCP: 25Gb) | Integrated slot | 1 |
| Broadcom (OCP: 25Gb) | Integrated slot | 1 |
| Broadcom (OCP: 10Gb) | Integrated slot | 1 |
| Broadcom (OCP: 10Gb) | Integrated slot | 1 |
| Intel (OCP: 10Gb) | Integrated slot | 1 |
| Intel (OCP: 10Gb) | Integrated slot | 1 |

Table 88. Config6. R2A (continued)

| CARD TYPE | SLOT PRIORITY | MAXIMUM NUMBER OF CARDS |
|----------------------|-----------------|-------------------------|
| Broadcom (OCP: 10Gb) | Integrated slot | 1 |
| Broadcom (OCP: 1Gb) | Integrated slot | 1 |
| Intel (OCP: 1Gb) | Integrated slot | 1 |
| Broadcom (OCP: 1Gb) | Integrated slot | 1 |
| FOXCONN (BOSS) | Integrated slot | 1 |
| FOXCONN (BOSS) | Integrated slot | 1 |

Table 89. Config7. R2U + R3S

| CARD TYPE | SLOT PRIORITY | MAXIMUM NUMBER OF CARDS |
|----------------------------|-----------------|-------------------------|
| Inventec (1U Serial board) | 3 | 1 |
| FOXCONN (Front PERC) | Integrated slot | 2 |
| FOXCONN (Front PERC) | Integrated slot | 2 |
| FOXCONN (Front PERC) | Integrated slot | 2 |
| FOXCONN (Front PERC) | Integrated slot | 1 |
| FOXCONN (Front PERC) | Integrated slot | 1 |
| FOXCONN (Front PERC) | Integrated slot | 1 |
| FOXCONN (Front PERC) | Integrated slot | 1 |
| FOXCONN (External Adapter) | 1,3 | 2 |
| (External Adapter) | 1,3 | 2 |
| (External Adapter) | 1,3 | 2 |
| Inventec (LOM Card) | Integrated slot | 1 |
| Inventec (LOM Card) | Integrated slot | 1 |
| Mellanox (NIC: 400Gb) | 1,3 | 2 |
| Broadcom (NIC: 100Gb) | 1,3 | 2 |
| Intel (NIC: 100Gb) | 1,3 | 2 |
| Mellanox (NIC: 100Gb) | 1,3 | 2 |
| Intel (NIC: 100Gb) | 1,3 | 2 |
| Intel (NIC: 25Gb) | 1,3 | 2 |
| Mellanox (NIC: 25Gb) | 1,3 | 2 |
| Broadcom (NIC: 25Gb) | 1,3 | 2 |
| Broadcom (HBA: FC64) | 1,3 | 2 |
| Broadcom (HBA: FC32) | 1,3 | 2 |
| Broadcom (HBA: FC32) | 1,3 | 2 |
| Marvell (HBA: FC32) | 1,3 | 2 |
| Marvell (HBA: FC32) | 1,3 | 2 |
| Broadcom (NIC: 10Gb) | 1,3 | 2 |
| Broadcom (NIC: 10Gb) | 1,3 | 2 |
| Intel (NIC: 10Gb) | 1,3 | 2 |

Table 89. Config7. R2U + R3S (continued)

| CARD TYPE | SLOT PRIORITY | MAXIMUM NUMBER OF CARDS |
|------------------------|-----------------|-------------------------|
| Intel (NIC: 10Gb) | 1,3 | 2 |
| Intel (NIC: 1Gb) | 1,3 | 2 |
| Broadcom (NIC: 1Gb) | 1,3 | 2 |
| Mellanox (NIC: NDR200) | 1,3 | 2 |
| Mellanox (NIC: HDRV) | 1,3 | 2 |
| Intel (OCP: 25Gb) | Integrated slot | 1 |
| Intel (OCP: 25Gb) | Integrated slot | 1 |
| Mellanox (OCP: 25Gb) | Integrated slot | 1 |
| Broadcom (OCP: 25Gb) | Integrated slot | 1 |
| Broadcom (OCP: 25Gb) | Integrated slot | 1 |
| Broadcom (OCP: 25Gb) | Integrated slot | 1 |
| Broadcom (OCP: 25Gb) | Integrated slot | 1 |
| Broadcom (OCP: 10Gb) | Integrated slot | 1 |
| Broadcom (OCP: 10Gb) | Integrated slot | 1 |
| Intel (OCP: 10Gb) | Integrated slot | 1 |
| Intel (OCP: 10Gb) | Integrated slot | 1 |
| Broadcom (OCP: 10Gb) | Integrated slot | 1 |
| Broadcom (OCP: 1Gb) | Integrated slot | 1 |
| Intel (OCP: 1Gb) | Integrated slot | 1 |
| Broadcom (OCP: 1Gb) | Integrated slot | 1 |
| FOXCONN (BOSS) | Integrated slot | 1 |
| FOXCONN (BOSS) | Integrated slot | 1 |

Table 90. Config8. R2T + R3A

| CARD TYPE | SLOT PRIORITY | MAXIMUM NUMBER OF CARDS |
|----------------------------|---------------|-------------------------|
| Inventec (1U Serial board) | 3 | 1 |
| FOXCONN (Front PERC) | INT | 1 |
| FOXCONN (Front PERC) | INT | 1 |
| FOXCONN (Front PERC) | INT | 1 |
| (External Adapter) | 1,2,3 | 3 |
| (External Adapter) | 1,2,3 | 3 |
| Inventec (LOM Card) | INT | 1 |
| Inventec (LOM Card) | INT | 1 |
| Mellanox (NIC: 400Gb) | 1,2,3 | 3 |
| Broadcom (NIC: 100Gb) | 1,2,3 | 3 |
| Intel (NIC: 100Gb) | 1,2,3 | 3 |
| Mellanox (NIC: 100Gb) | 1,2,3 | 3 |
| Intel (NIC: 100Gb) | 1,2,3 | 3 |

Table 90. Config8. R2T + R3A (continued)

| CARD TYPE | SLOT PRIORITY | MAXIMUM NUMBER OF CARDS |
|------------------------|---------------|-------------------------|
| Intel (NIC: 25Gb) | 1,2,3 | 3 |
| Mellanox (NIC: 25Gb) | 1,2,3 | 3 |
| Broadcom (NIC: 25Gb) | 1,2,3 | 3 |
| Broadcom (HBA: FC64) | 1,2,3 | 3 |
| Broadcom (HBA: FC32) | 1,2,3 | 3 |
| Broadcom (HBA: FC32) | 1,2,3 | 3 |
| Marvell (HBA: FC32) | 1,2,3 | 3 |
| Marvell (HBA: FC32) | 1,2,3 | 3 |
| Broadcom (NIC: 10Gb) | 1,2,3 | 3 |
| Broadcom (NIC: 10Gb) | 1,2,3 | 3 |
| Intel (NIC: 10Gb) | 1,2,3 | 3 |
| Intel (NIC: 10Gb) | 1,2,3 | 3 |
| Intel (NIC: 1Gb) | 1,2,3 | 3 |
| Broadcom (NIC: 1Gb) | 1,2,3 | 3 |
| Mellanox (NIC: NDR200) | 1,2,3 | 3 |
| Mellanox (NIC: HDRV) | 1,2,3 | 3 |
| Intel (OCP: 25Gb) | INT | 1 |
| Intel (OCP: 25Gb) | INT | 1 |
| Mellanox (OCP: 25Gb) | INT | 1 |
| Broadcom (OCP: 25Gb) | INT | 1 |
| Broadcom (OCP: 25Gb) | INT | 1 |
| Broadcom (OCP: 25Gb) | INT | 1 |
| Broadcom (OCP: 25Gb) | INT | 1 |
| Broadcom (OCP: 25Gb) | INT | 1 |
| Broadcom (OCP: 10Gb) | INT | 1 |
| Broadcom (OCP: 10Gb) | INT | 1 |
| Intel (OCP: 10Gb) | INT | 1 |
| Intel (OCP: 10Gb) | INT | 1 |
| Broadcom (OCP: 10Gb) | INT | 1 |
| Broadcom (OCP: 1Gb) | INT | 1 |
| Intel (OCP: 1Gb) | INT | 1 |
| Broadcom (OCP: 1Gb) | INT | 1 |
| FOXCONN (BOSS) | INT | 1 |
| FOXCONN (BOSS) | INT | 1 |

Removing the expansion card risers

Prerequisites

1. Follow the safety guidelines listed in the [Safety instructions](#).

2. Follow the procedure listed in the [Before working inside your system.](#)
3. [Remove the air shroud.](#)
4.  **NOTE:** If BOSS-N1 module is installed, ensure to disconnect the BOSS-N1 power cable and Signal cable before removing the Riser 1 cage.

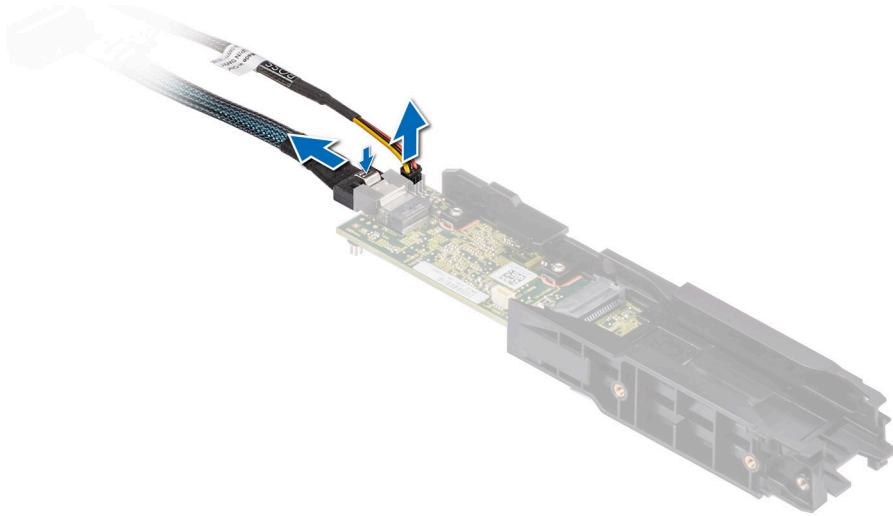

5. If applicable, disconnect the cables from the expansion card or system board.

Steps

1. Loosen the captive screws on the riser and system.
2. Press the blue release tab or blue button on the riser and holding the edges lift the expansion card riser from the riser connector on the system board.

 **NOTE:** The numbers on the image do not depict the exact steps. The numbers are for representation of sequence.

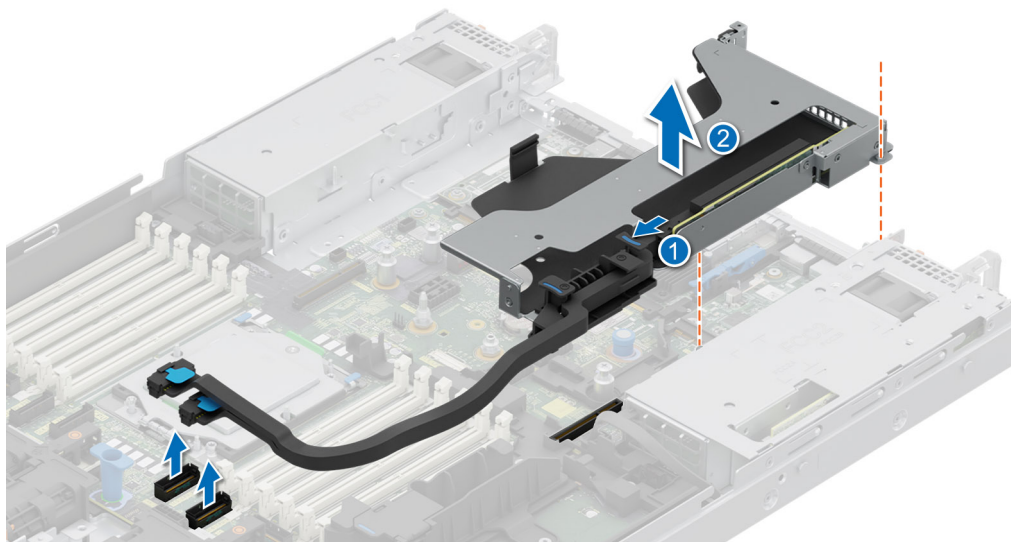

Figure 87. Removing the expansion card riser 1

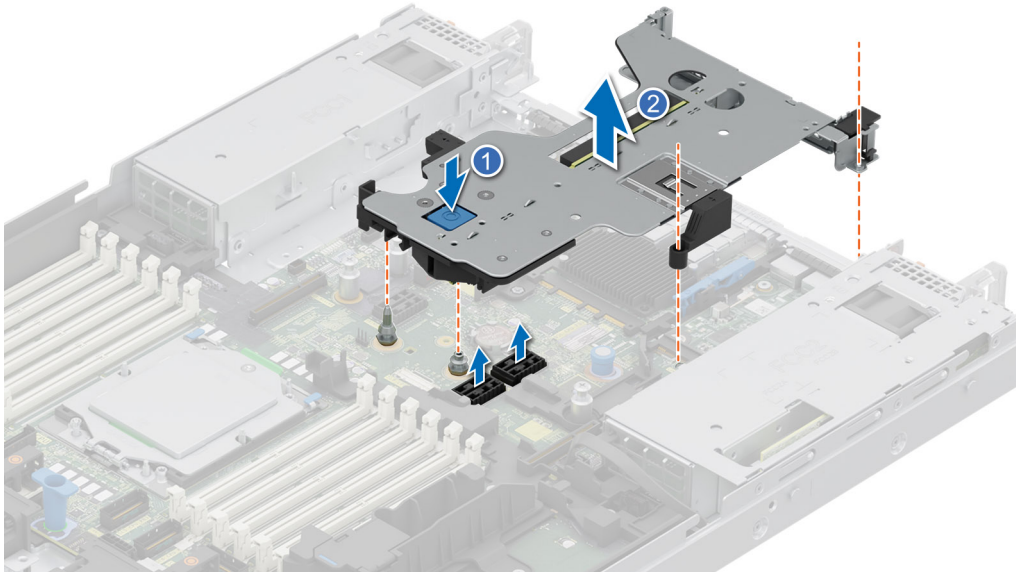

Figure 88. Removing the expansion card riser 2

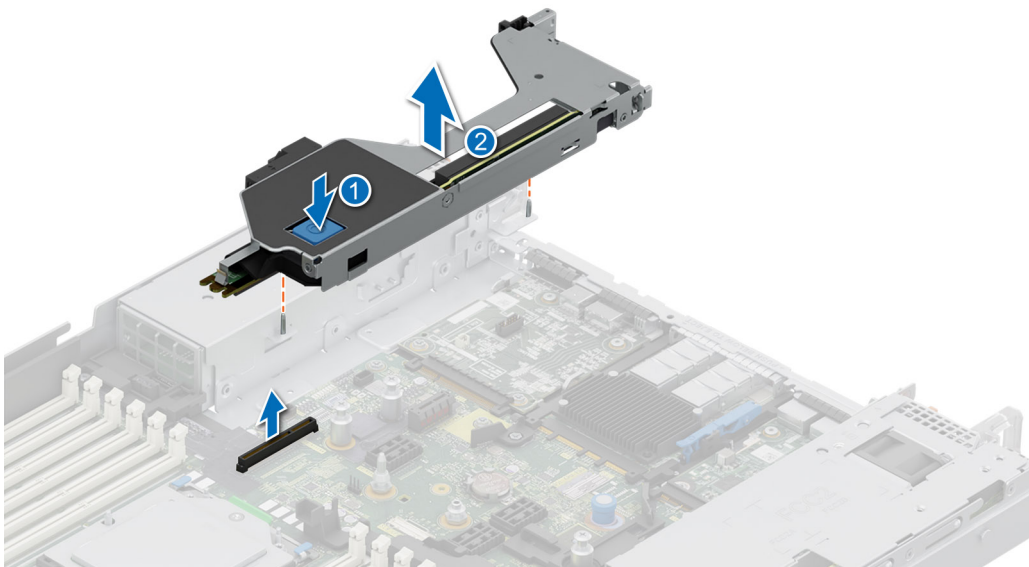

Figure 89. Removing the expansion card riser 3

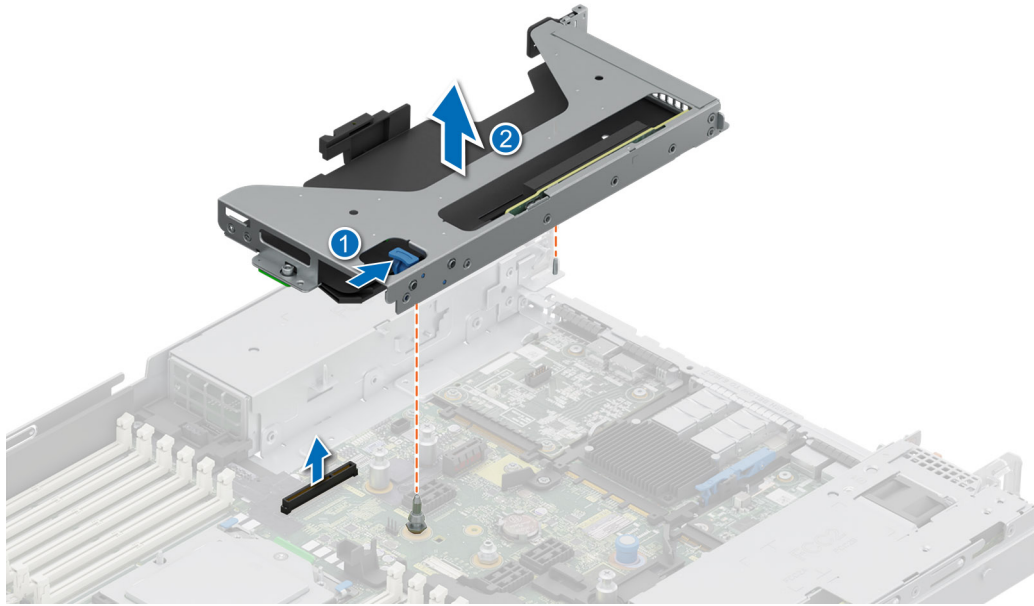

Figure 90. Removing the expansion card riser 4

3. If the risers are not going to be replaced, install riser blanks, and if required tighten the captive screws.

i **NOTE:** You must install a filler bracket over an empty expansion card slot to maintain Federal Communications Commission (FCC) certification of the system. The brackets also keep dust and dirt out of the system and aid in proper cooling and airflow inside the system.

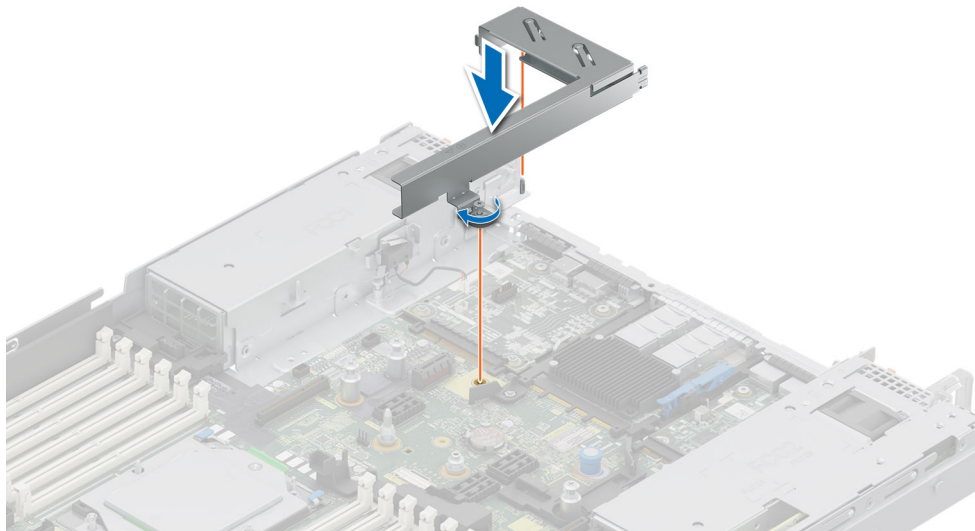

Figure 91. Installing the Riser 1 blank

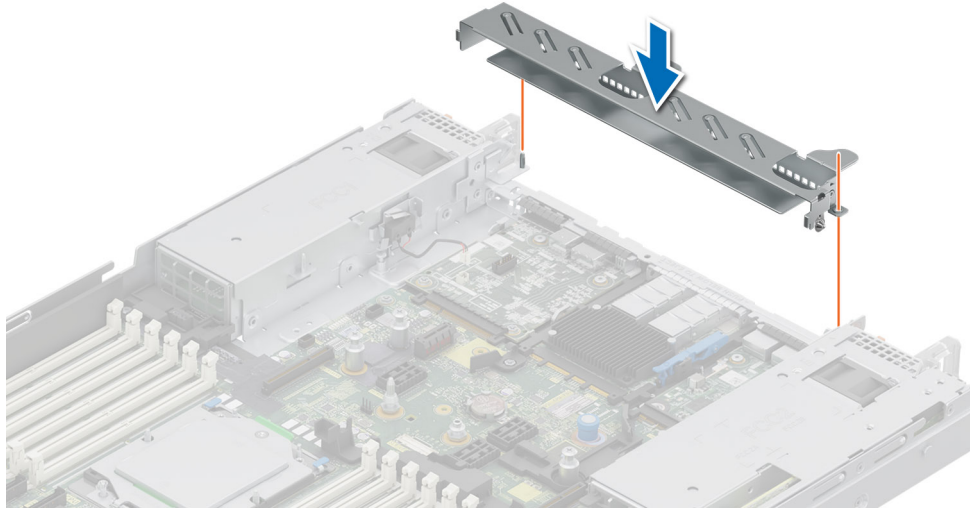

Figure 92. Installing the Riser 2 blank

Next steps

1. [Replace the expansion card riser.](#)

Installing the expansion card risers

Prerequisites

1. Follow the safety guidelines listed in the [Safety instructions](#).
2. Follow the procedure listed in the [Before working inside your system](#).
3. [Remove the air shroud](#).
4. If removed, [install the expansion cards into the expansion card risers](#).

i **NOTE:** Install Riser 2 before installing Riser 1 and Riser 3. Install Riser 4 after installing Riser 3.

⚠ CAUTION: Do not install GPUs, network cards, or other PCIe devices on your system that are not validated and tested by Dell. Damage caused by unauthorized and invalidated hardware installation will null and void the system warranty.

Steps

1. If installed, remove the riser blanks and if required loosen the captive screws.

i **NOTE:** Store the riser blanks for future use. Filler brackets must be installed in empty expansion card slots to maintain Federal Communications Commission (FCC) certification of the system. The brackets also keep dust and dirt out of the system and aid in proper cooling and airflow inside the system.

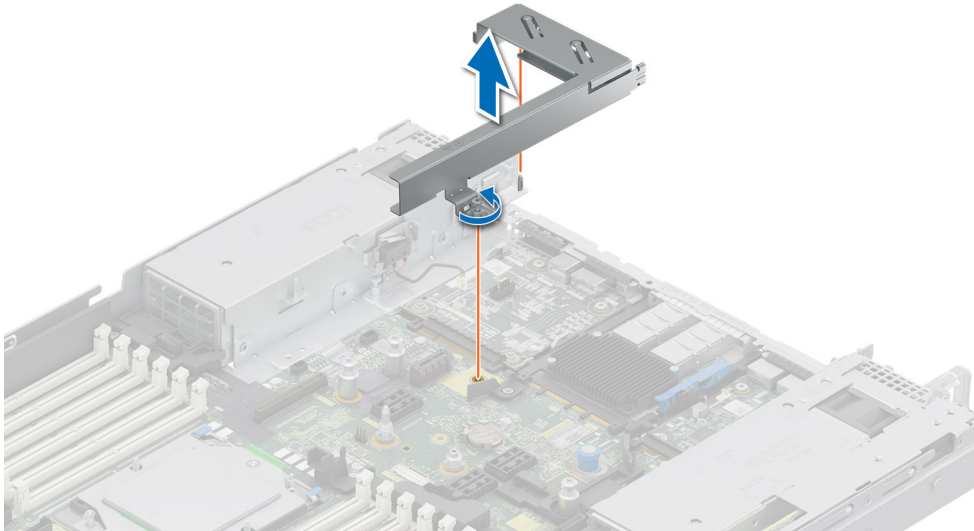

Figure 93. Removing the Riser 1 blank

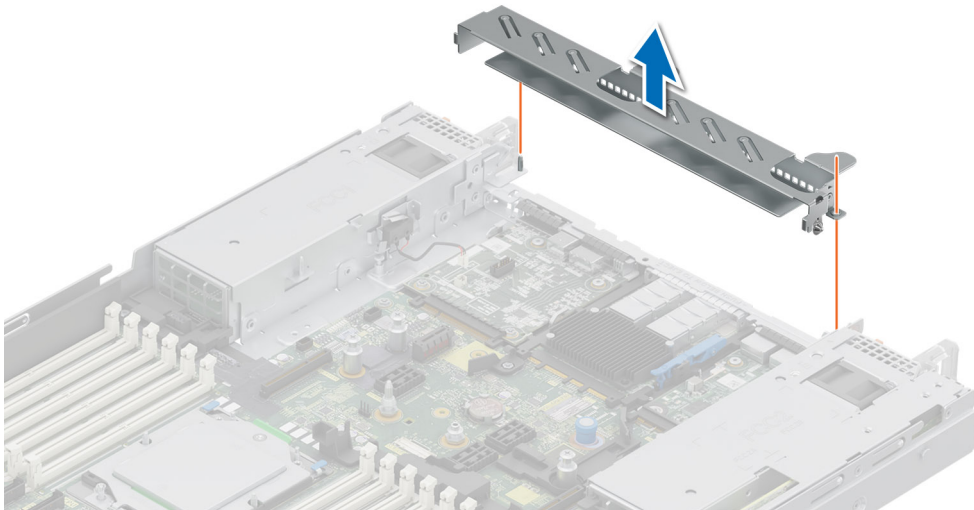

Figure 94. Removing the Riser 2 blank

2. Holding the edges or the touch points, align the holes on the expansion card riser with the guides on the system board.
3. Lower the expansion card riser into place and press the touch points until the expansion card riser connector is fully seated on the system board connector.
4. Tighten the captive screws on the risers and system if any.

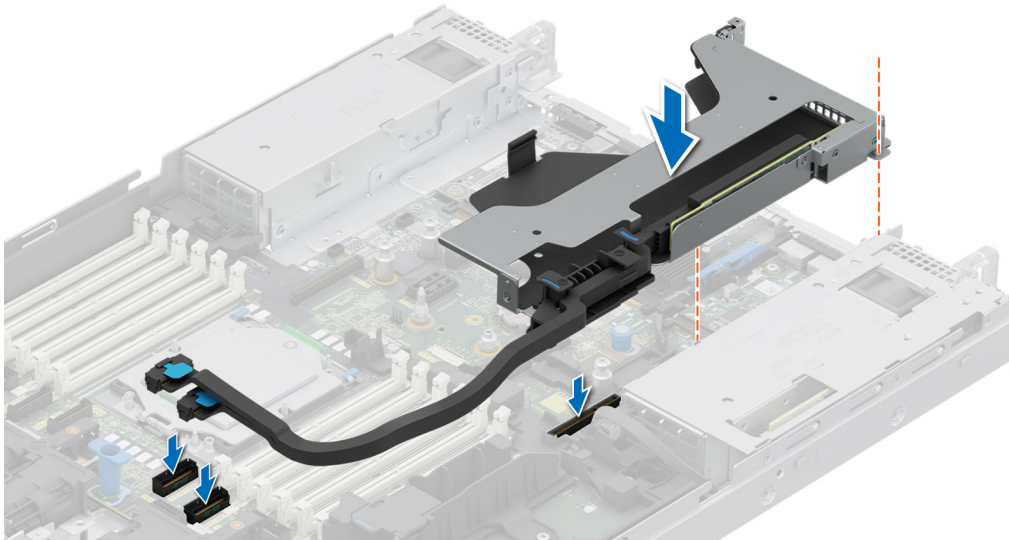

Figure 95. Installing the expansion card riser 1

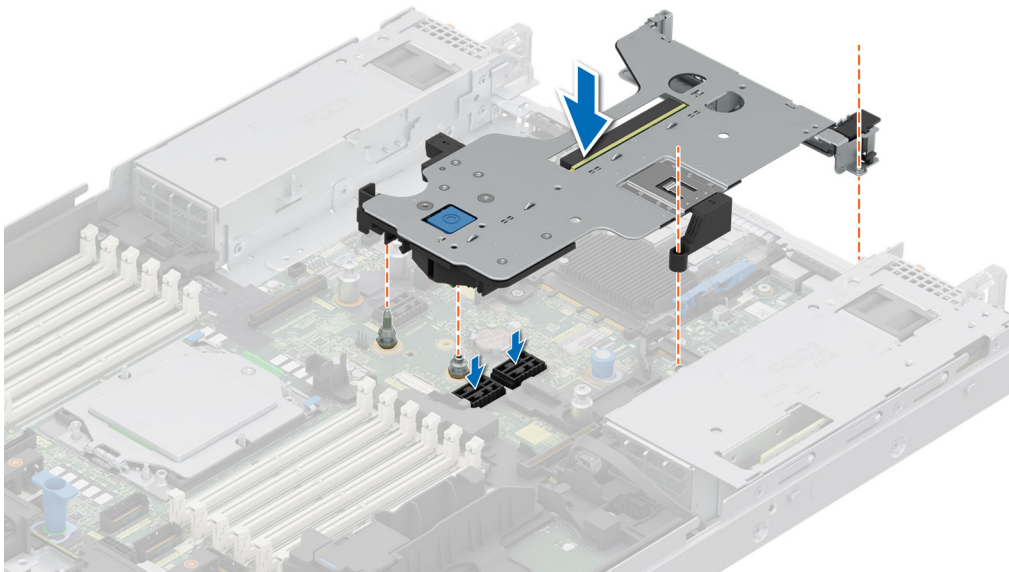

Figure 96. Installing the expansion card riser 2

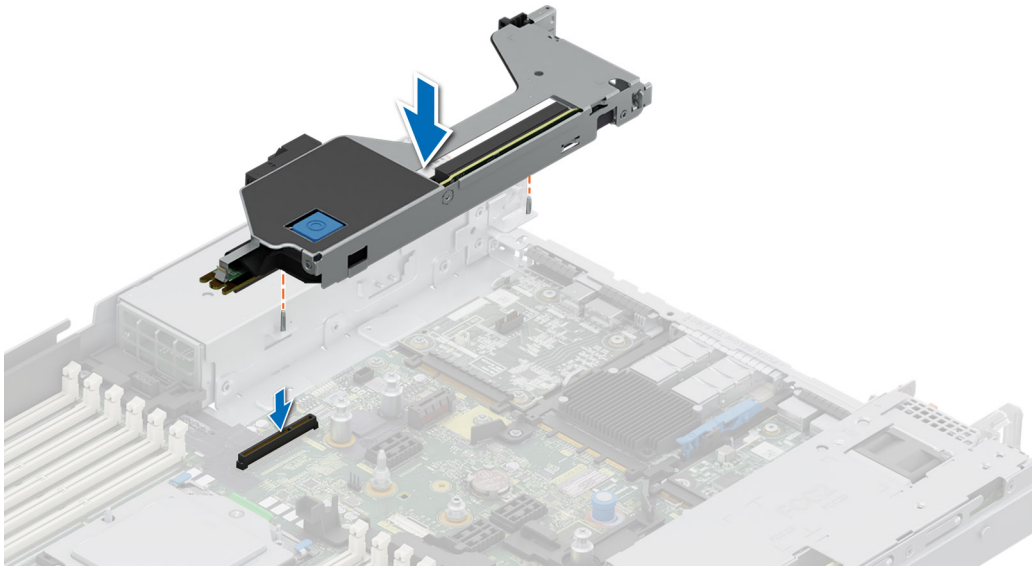

Figure 97. Installing the expansion card riser 3

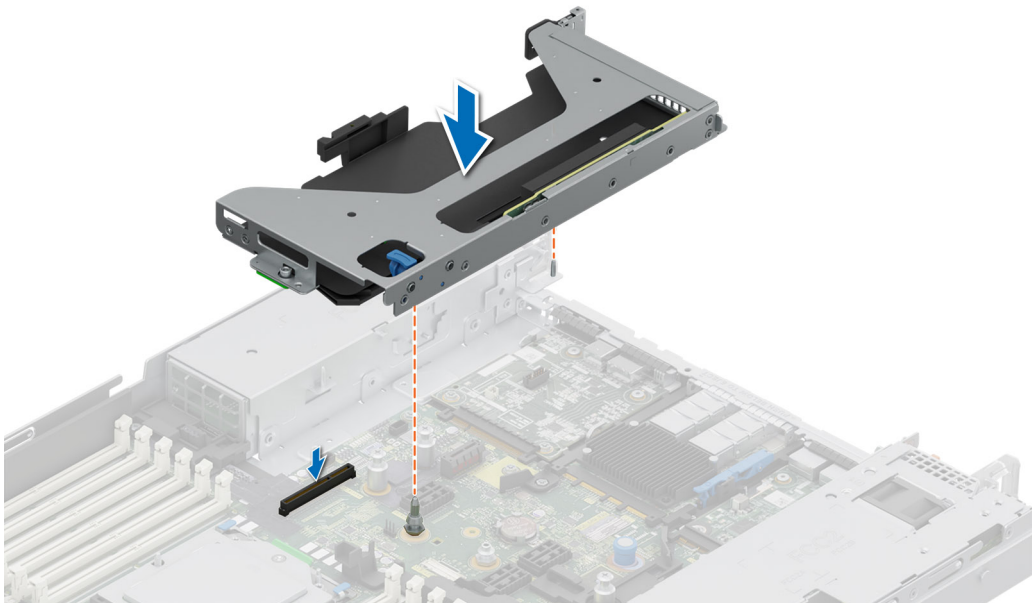

Figure 98. Installing the expansion card riser 4

Next steps

1. If required, reconnect the cables to the expansion card or system board.
2. [Install the air shroud](#) .
3. Follow the procedure listed in [After working inside your system](#).
4. Install any device drivers required for the card as described in the documentation for the card.

Removing expansion card from the expansion card riser

Prerequisites

1. Follow the safety guidelines listed in the [Safety instructions](#).
2. Follow the procedure listed in the [Before working inside your system](#).

3. If applicable, disconnect the cables from the expansion card.
4. Remove the air shroud.
5. Remove the expansion card riser.

Steps

1. Tilt the expansion card retention latch lock to open.
2. Pull the card holder before removing the card from the riser.
3. Hold the expansion card by the edges and pull the card from the riser.

NOTE: The numbers on the image do not depict the exact steps. The numbers are for representation of sequence.

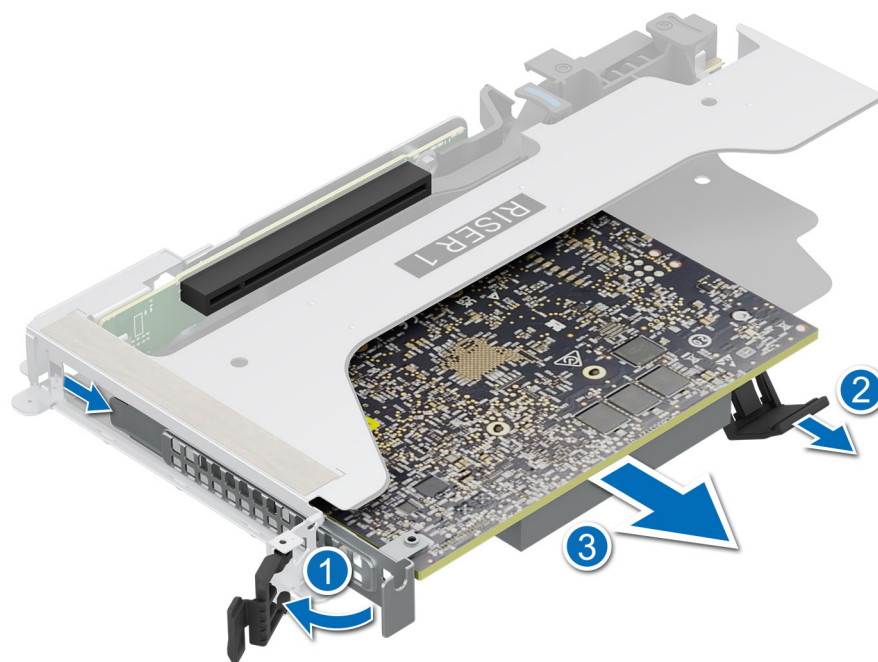

Figure 99. Removing expansion card from the expansion card riser

4. If the expansion card is not going to be replaced, install a filler bracket and close the card retention latch.

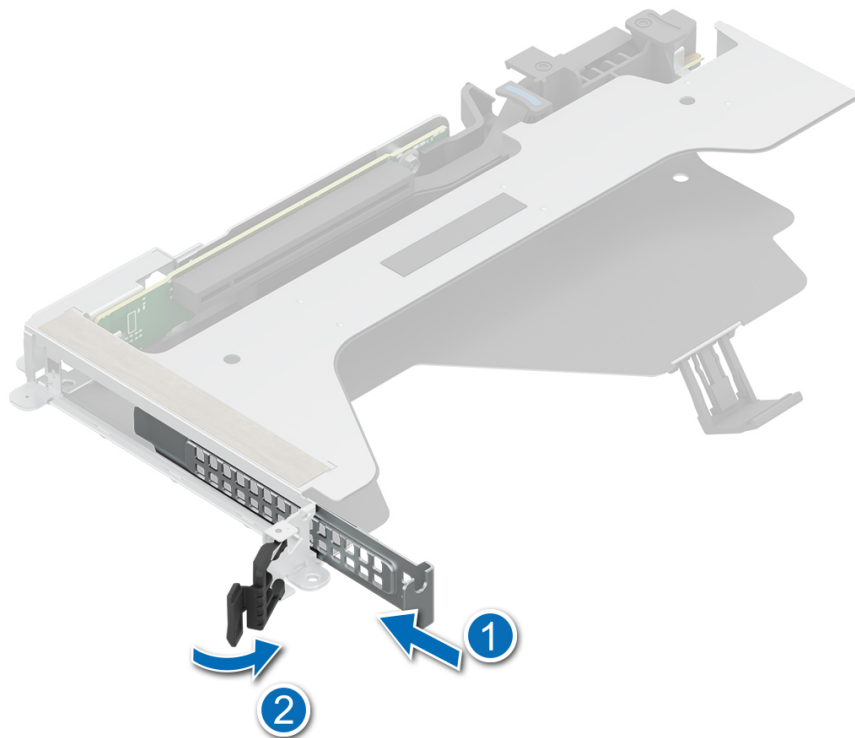

Figure 100. Installing the filler bracket

Next steps

1. If applicable, [install an expansion card into the expansion card riser](#).

Installing an expansion card into the expansion card riser

Prerequisites

1. Follow the safety guidelines listed in the [Safety instructions](#).
2. Follow the procedure listed in the [Before working inside your system](#).
3. [Remove the air shroud](#).
4. [Remove the expansion card riser](#).
5. If installing a new expansion card, unpack it and prepare the card for installation.

 **NOTE:** For instructions, see the documentation accompanying the card.

 **CAUTION:** Do not install GPUs, network cards, or other PCIe devices on your system that are not validated and tested by Dell. Damage caused by unauthorized and invalidated hardware installation will null and void the system warranty.

Steps

1. Tilt the expansion card retention latch lock to open.

2. If installed, remove the filler bracket.

i **NOTE:** Store the filler bracket for future use. Filler brackets must be installed in empty expansion card slots to maintain Federal Communications Commission (FCC) certification of the system. The brackets also keep dust and dirt out of the system and aid in proper cooling and airflow inside the system.

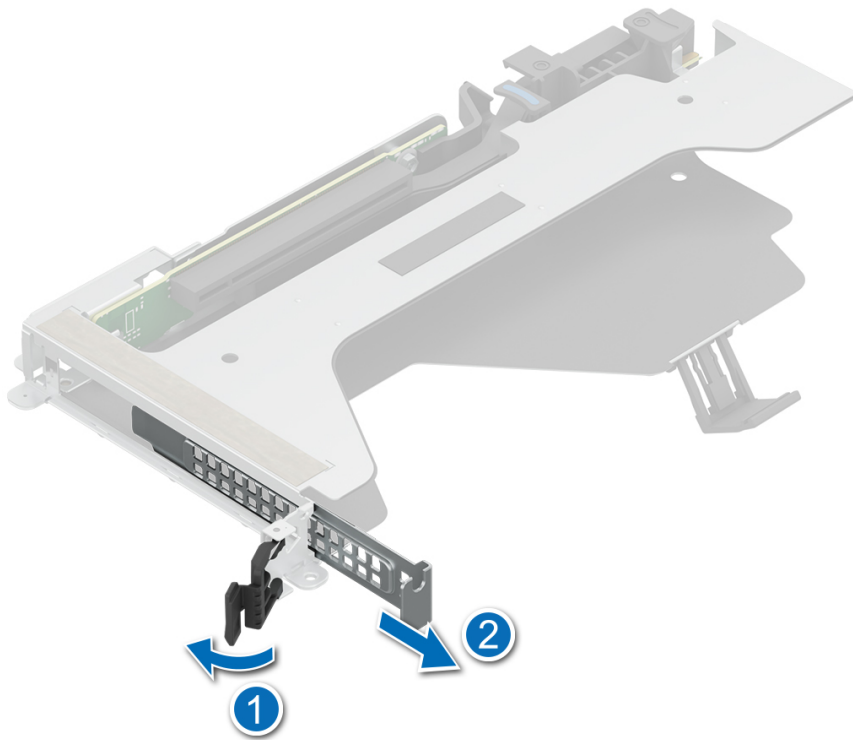

Figure 101. Removing the filler bracket

3. Hold the card by edges, and align the card with the connector on the riser.
4. Insert the card firmly into the expansion card connector until seated.
5. Close the expansion card retention latch.
6. Push the card holder to hold the card in the riser.

i **NOTE:** The numbers on the image do not depict the exact steps. The numbers are for representation of sequence.

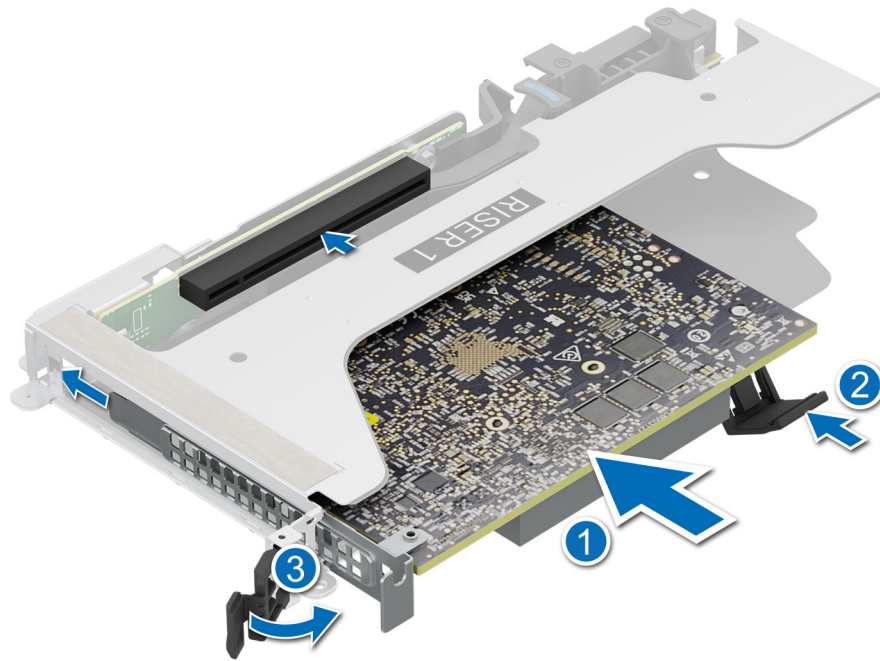

Figure 102. Installing an expansion card into the expansion card riser

Next steps

1. If applicable, connect the cables to the expansion card.
2. [Install the expansion card risers.](#)
3. [Install the air shroud.](#)
4. Follow the procedure listed in [After working inside your system.](#)
5. Install any device drivers required for the card as described in the documentation for the card.

Optional serial COM port

This is a service technician replaceable part only.

Removing the serial COM port

The procedure to remove serial COM port from Riser 3 or 4 is same.

Prerequisites

1. Follow the safety guidelines listed in the [Safety instructions.](#)
2. Follow the procedure listed in the [Before working inside your system.](#)
3. [Remove the air shroud.](#)

Steps

1. Disconnect the serial COM port cable from the connector on the rear I/O board.
2. Open the latch on the expansion card riser and slide the serial COM port out of the expansion card riser.

 **NOTE:** The numbers on the image do not depict the exact steps. The numbers are for representation of sequence.

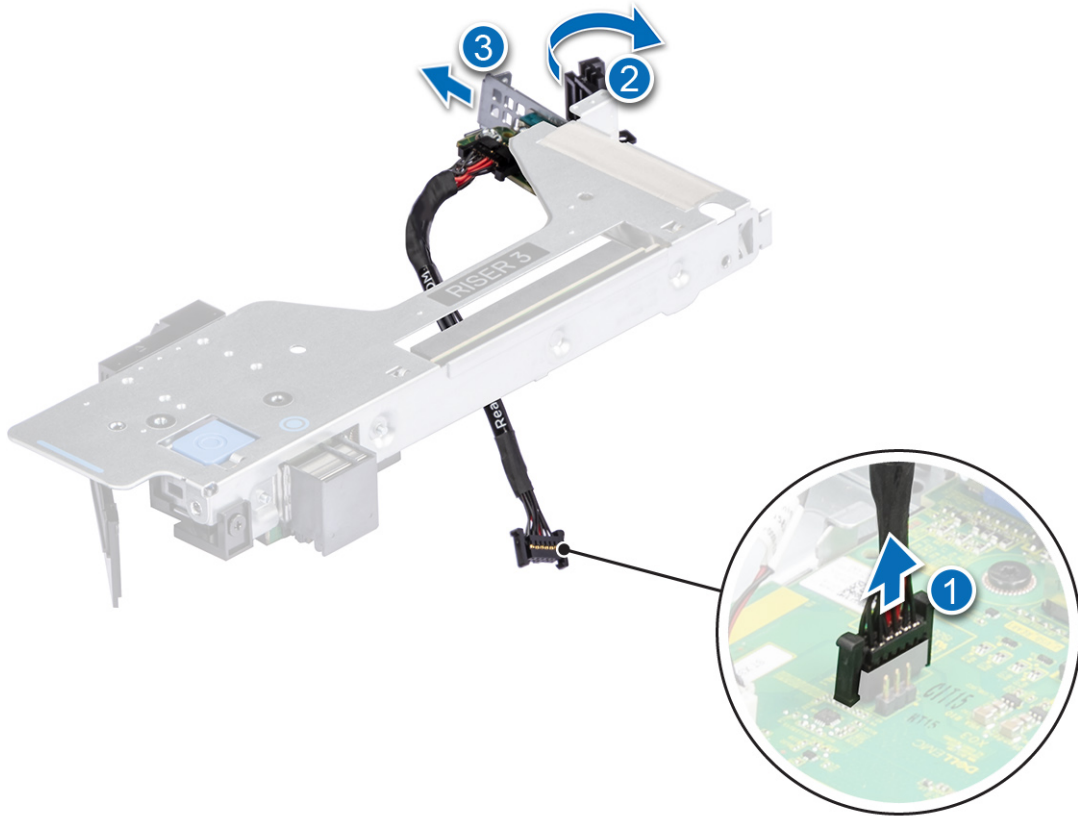

Figure 103. Removing the serial COM port

Next steps

1. [Replace the serial COM port.](#)

Installing the serial COM port

The procedure to install serial COM port to Riser 3 or 4 is same.

Prerequisites

1. Follow the safety guidelines listed in the [Safety instructions](#).
2. Follow the procedure listed in the [Before working inside your system](#).
3. [Remove the air shroud.](#)
4. [Remove expansion card riser.](#)

Steps

1. Open the latch on the expansion card riser and remove the filler bracket from the expansion card riser (Riser 3).

NOTE: For more information about how to remove the filler bracket, see the [Removing the expansion card from the expansion card riser](#) topic.

2. Slide the serial COM port into the expansion card riser.
3. Connect the serial COM port cable to the serial port.
4. Connect the serial COM port cable to the connector on the rear I/O board.

NOTE: The numbers on the image do not depict the exact steps. The numbers are for representation of sequence.

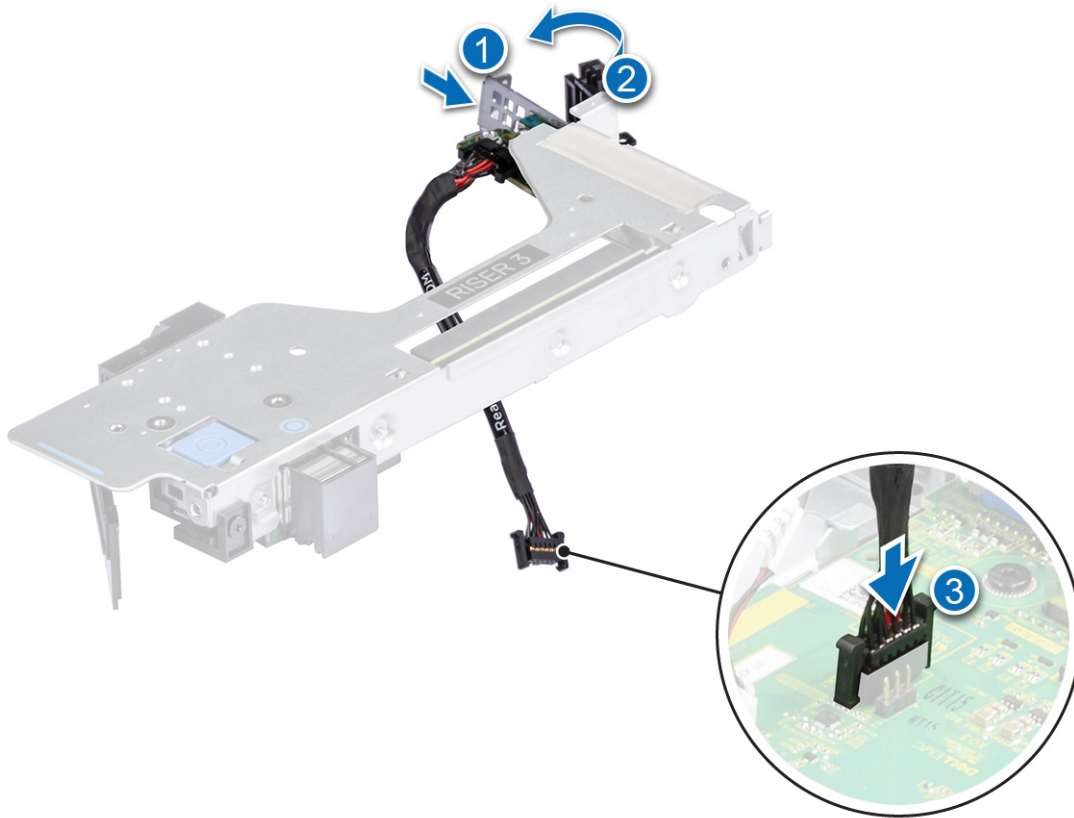

Figure 104. Installing the serial COM port

Next steps

1. [Install the air shroud.](#)
2. Follow the procedure listed in [After working inside your system.](#)

VGA module

Removing the VGA module

Prerequisites

1. Follow the safety guidelines listed in the [Safety instructions.](#)
2. Follow the procedure listed in the [Before working inside your system.](#)
3. If installed, [Remove the front bezel.](#)
4. [Remove the backplane cover.](#)
5. If installed, [Remove the air shroud.](#)

NOTE: Ensure that you note the routing of the cables as you remove them from the system board. Route the cable properly when you replace it to prevent the cable from being pinched or crimped

Steps

1. Disconnect the VGA cable from the connector on the system board and open the cable latch.
2. Disconnect the right control panel cable from the system board and move it away to see the VGA module screw on the system.

3. Using Phillips #2 screwdriver, remove the screw on the VGA module.
4. Slide the VGA module out of the system.

i **NOTE:** The numbers on the image do not depict the exact steps. The numbers are for representation of sequence.

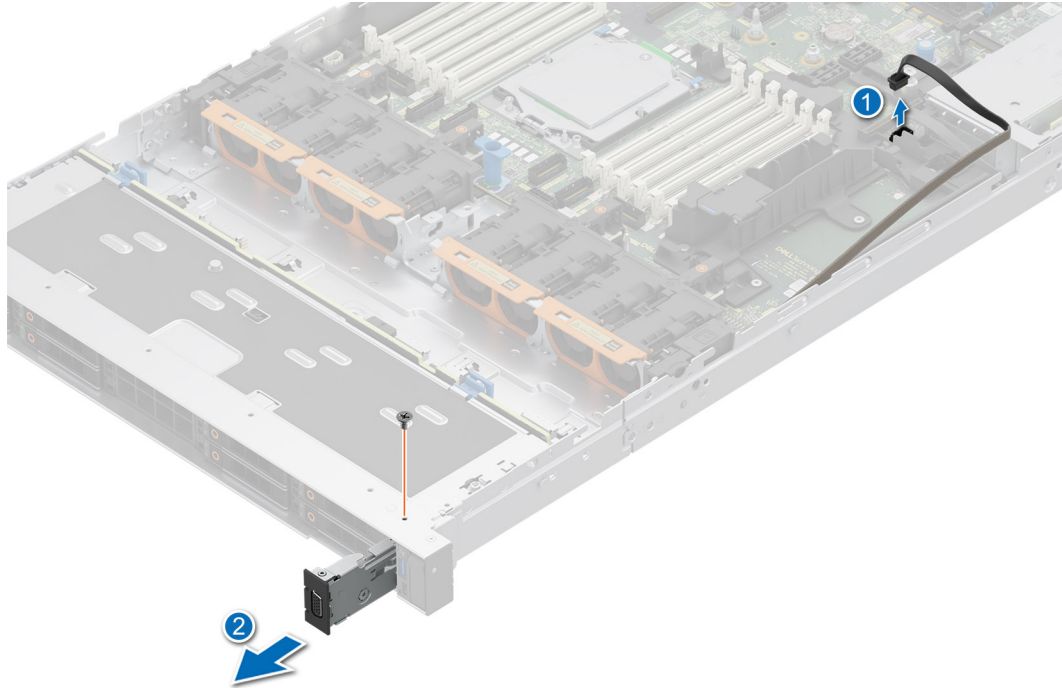

Figure 105. Removing the VGA module

Next steps

1. [Replace the VGA module.](#)

Installing the VGA module

Prerequisites

1. Follow the safety guidelines listed in the [Safety instructions](#).
2. Follow the procedure listed in the [Before working inside your system](#).
3. If installed, [Remove the front bezel](#).
4. [Remove the backplane cover](#).
5. If installed, [Remove the air shroud](#).

i **NOTE:** Ensure that you note the routing of the cables as you remove them from the system board. Route the cable properly when you replace it to prevent the cable from being pinched or crimped

Steps

1. Disconnect the VGA cable from the connector on the system board.
2. Pull the right control panel cable from the clip and move it to clear the path of the see the VGA module screw.
3. Route the VGA cable through the slot on the front of the system and slide the VGA module into the slot.
4. Align the hole on the module with the screw hole on the system.
5. Using the Phillips #2 screwdriver, secure the VGA module to the system with the screw.

i **NOTE:** The numbers on the image do not depict the exact steps. The numbers are for representation of sequence.

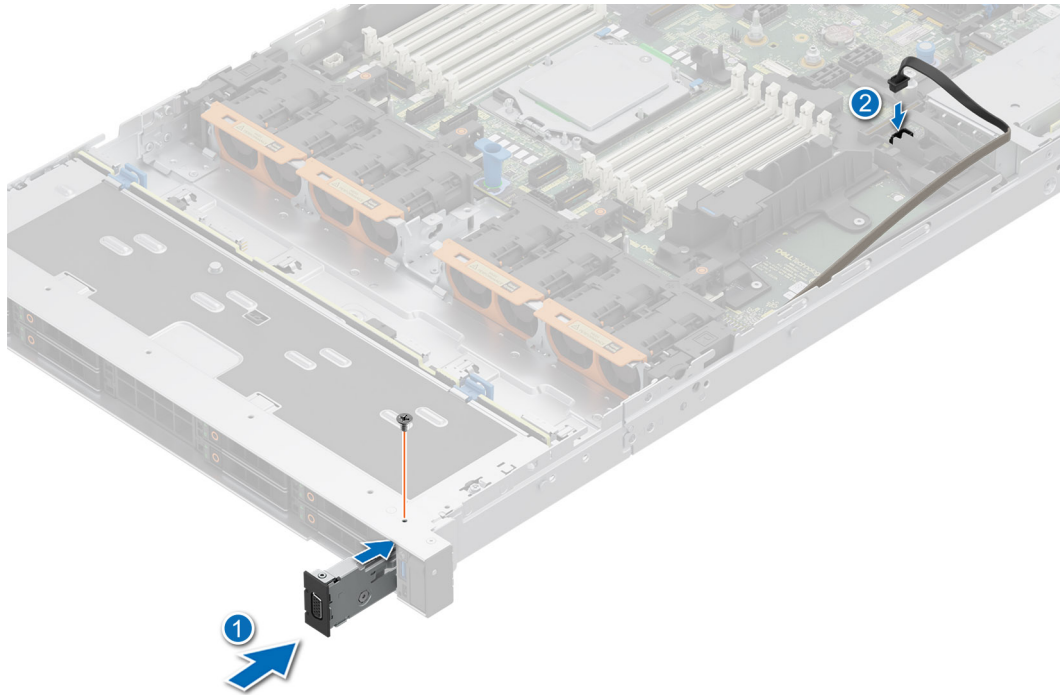

Figure 106. Installing the VGA module

Next steps

1. Route the VGA cable, close the cable latch, and connect the VGA cable to the connector on the system board.
2. Route and connect the right control panel cable.
3. If removed, [Install the air shroud](#).
4. [Install the backplane cover](#).
5. If installed, [Install the front bezel](#).
6. Follow the procedure listed in the [After working inside your system](#).

M.2 SSD module

Removing the M.2 NVMe SSD module

Prerequisites

1. Follow the safety guidelines listed in the [Safety instructions](#).
2. Follow the procedure listed in the [Before working inside your system](#).
3. Remove the [BOSS-N1 module](#).

Steps

1. Using the Phillips #1 screwdriver, remove the M3 x 0.5 x 4.5 mm screw securing the M.2 NVMe SSD module to the BOSS-N1 card.
2. Pull the M.2 NVMe SSD module to disconnect from the BOSS-N1 card connector.

NOTE: The numbers on the image do not depict the exact steps. The numbers are for representation of sequence.

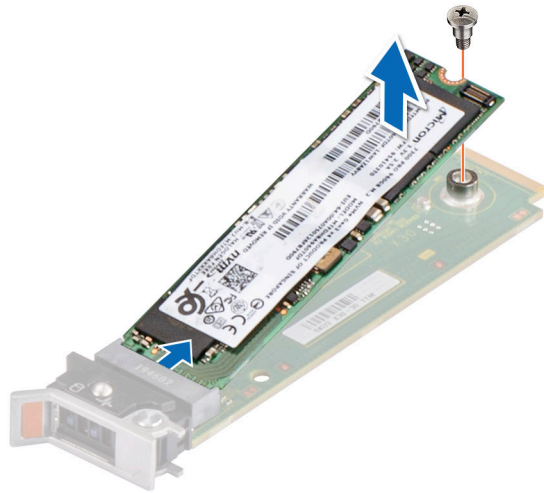

Figure 107. Removing the M.2 NVMe SSD module

Next steps

1. Replace the M.2 NVMe SSD module.

Installing the M.2 NVMe SSD module

Prerequisites

1. Follow the safety guidelines listed in the [Safety instructions](#).
2. Follow the procedure listed in the [Before working inside your system](#).
3. Remove the [BOSS-N1 module](#).

Steps

1. Align the M.2 NVMe SSD module at an angle with the BOSS-N1 card connector.
2. Insert the M.2 NVMe SSD module until it is firmly seated in the BOSS-N1 card connector.
3. Using the Phillips #1 screwdriver, secure the M.2 NVMe SSD module on the BOSS-N1 card with the M3 x 0.5 x 4.5 mm screw.

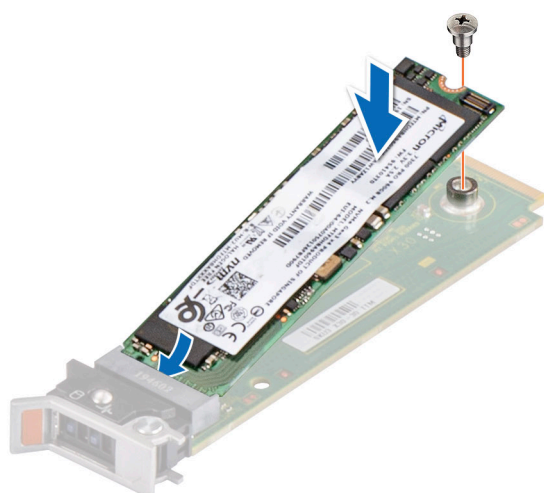

Figure 108. Installing the M.2 NVMe SSD module

Next steps

1. Install the [BOSS_N1 module](#).
2. Follow the procedure listed in the [After working inside your system](#).

Optional BOSS-N1 module

Removing the BOSS-N1 module blank

Prerequisites

Follow the safety guidelines listed in the [Safety instructions](#).

Steps

1. Using a Phillips #1 screwdriver, remove the screw that secures the BOSS-N1 module bay to the chassis.
2. Remove the blank from the BOSS-N1 module bay.

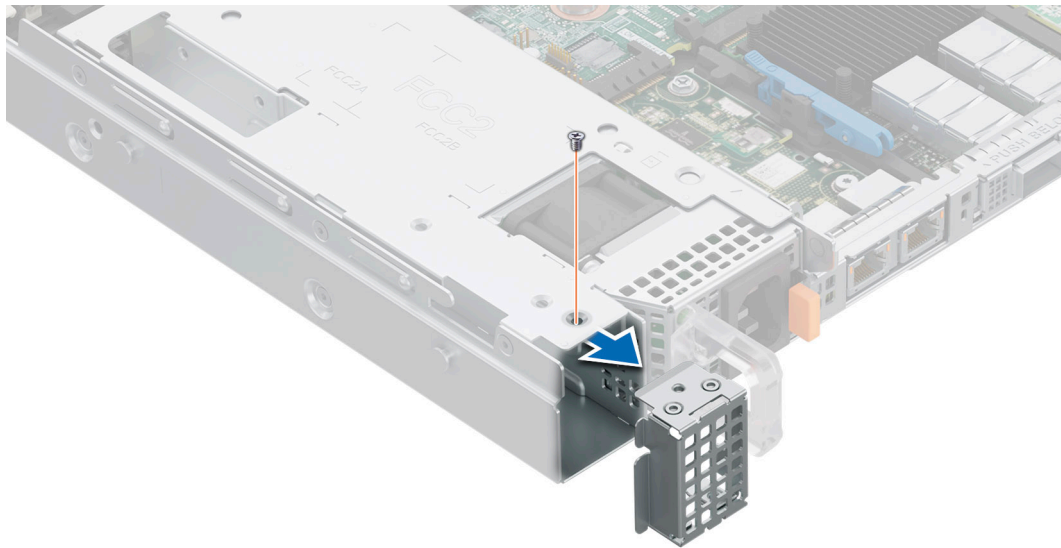

Figure 109. Removing the BOSS-N1 module blank

Next steps

1. [Replace the BOSS-N1 module blank](#) or install BOSS-N1 module.

Installing the BOSS-N1 module blank

Prerequisites

1. Follow the safety guidelines listed in the [Safety instructions](#).

Steps

Align the blank with the BOSS-N1 module bay and push it into the bay until it clicks into place.

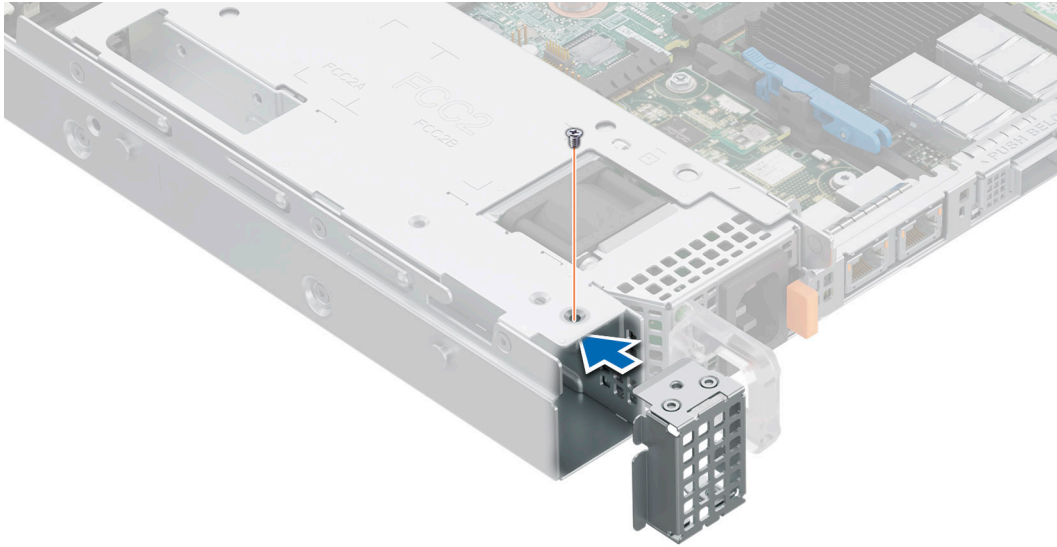

Figure 110. Installing the BOSS-N1 module blank

Removing the BOSS-N1 card carrier blank

Prerequisites

Follow the safety guidelines listed in the [Safety instructions](#).

Steps

1. Disconnect the power cable and the signal cable from the system board.
2. Using a Phillips #1 screwdriver, remove the screws that secures the BOSS-N1 card carrier blank to the chassis.
3. Remove the BOSS-N1 card carrier blank out from the BOSS-N1 module.

NOTE: The numbers on the image do not depict the exact steps. The numbers are for representation of sequence.

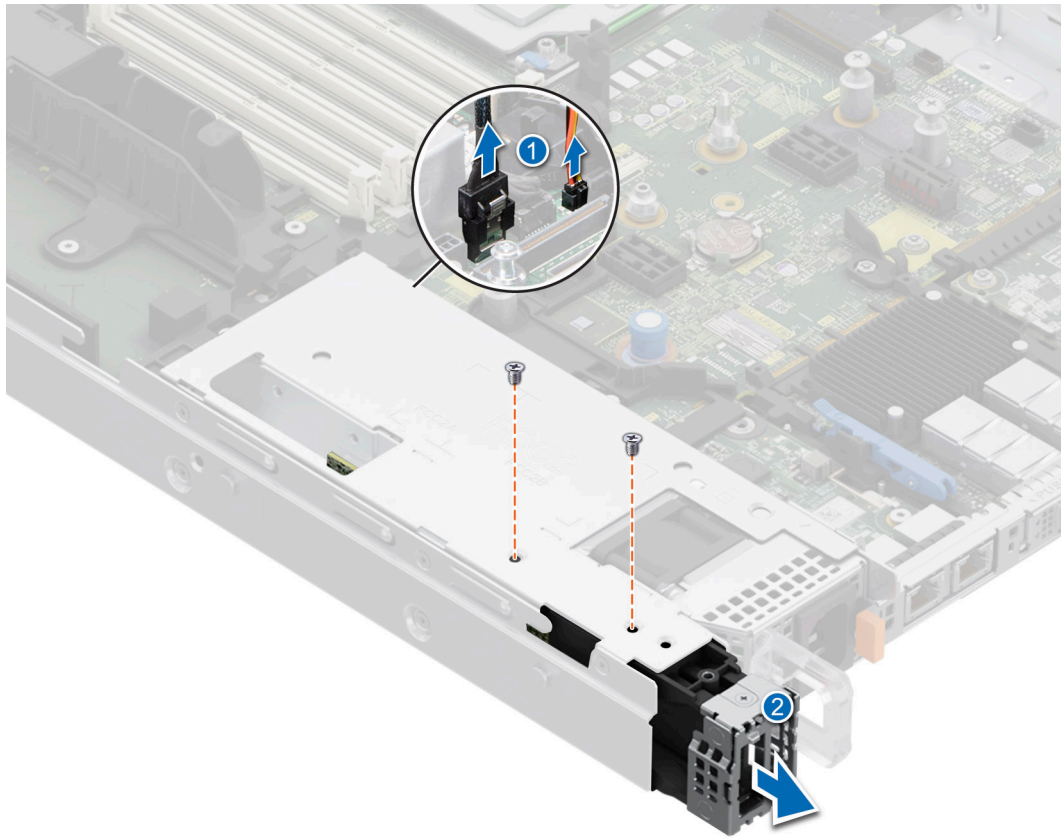

Figure 111. Removing the BOSS-N1 card carrier blank

Next steps

1. [Replace the BOSS-N1 card carrier blank](#) or install BOSS-N1 card carrier.

Installing the BOSS-N1 card carrier blank

Prerequisites

1. Follow the safety guidelines listed in the [Safety instructions](#).

Steps

1. Align the blank with the BOSS-N1 module bay and push it into the bay until it clicks into place.
2. Using a Phillips #1 screwdriver, replace the screws that secures the BOSS-N1 card carrier blank to the chassis.
3. Connect the power cable and the signal cable to the system board.

NOTE: The numbers on the image do not depict the exact steps. The numbers are for representation of sequence.

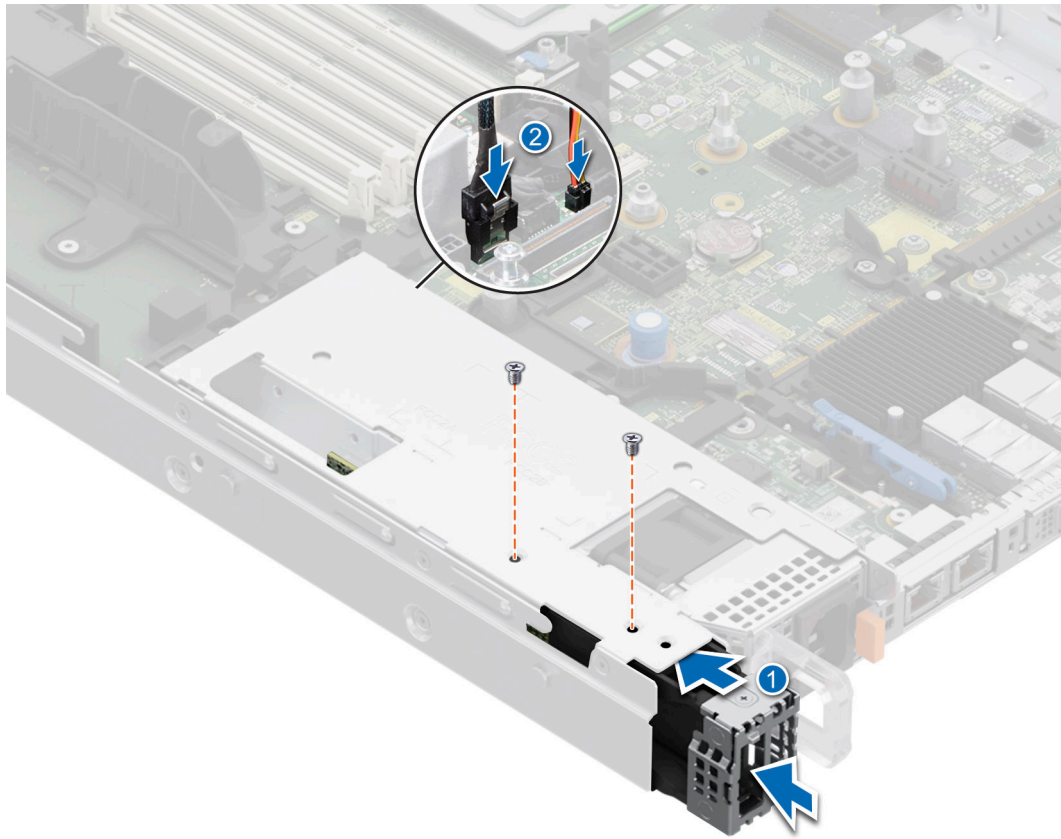

Figure 112. Installing the BOSS-N1 card carrier blank

Removing the BOSS-N1 module

The procedure to remove is the BOSS-N1 module with 4 x 2.5-inch rear drive module is similar.

Prerequisites

1. Follow the safety guidelines listed in the [Safety instructions](#).
2. Follow the procedure listed in the [Before working inside your system](#).

Steps

1. Pull and lift the BOSS-N1 card carrier retention latch lock to open.
2. Slide the BOSS-N1 card carrier out.

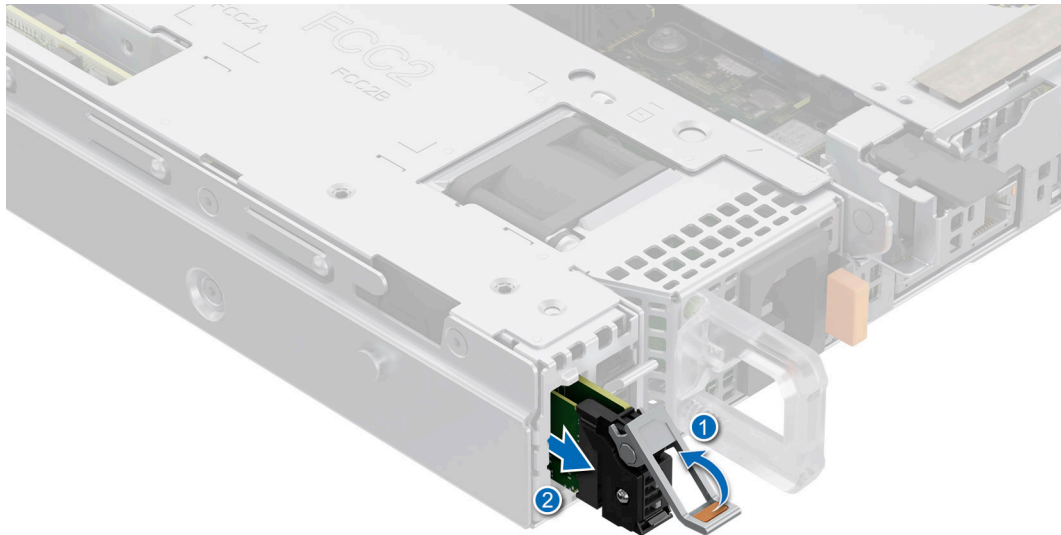

Figure 113. Removing the BOSS-N1 card carrier

3. Using the Phillips #1 screwdriver remove the M3 x 0.5 x 4.5 mm screw that secures the M.2 SSD to the BOSS-N1 card carrier.
4. Slide the M.2 SSD out from the BOSS-N1 card carrier.

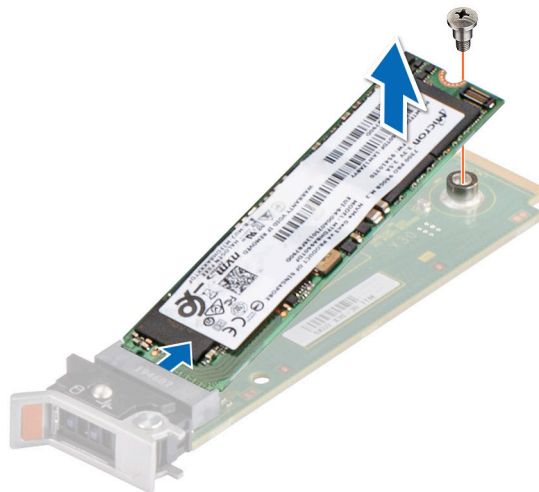

Figure 114. Removing the M.2 SSD

5. Disconnect the BOSS-N1 power and signal cable from the system board.
6. Using the Phillips #1 screwdriver remove the M3 x 0.5 x 4.5 mm screws that secures the BOSS-N1 module .
7. Slide the BOSS-N1 module towards the front of the chassis and lift the module.

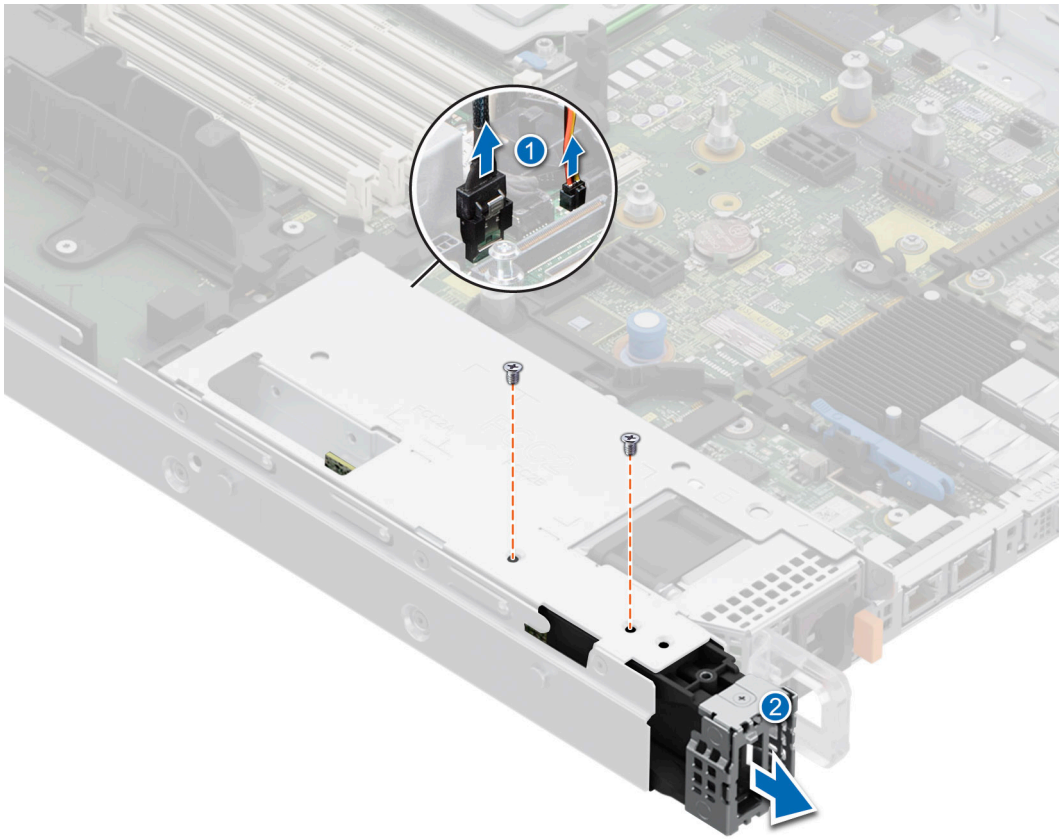

Figure 115. Removing the BOSS-N1 module

8. Press the metal clip to remove the BOSS-N1 signal cable from the BOSS-N1 module.

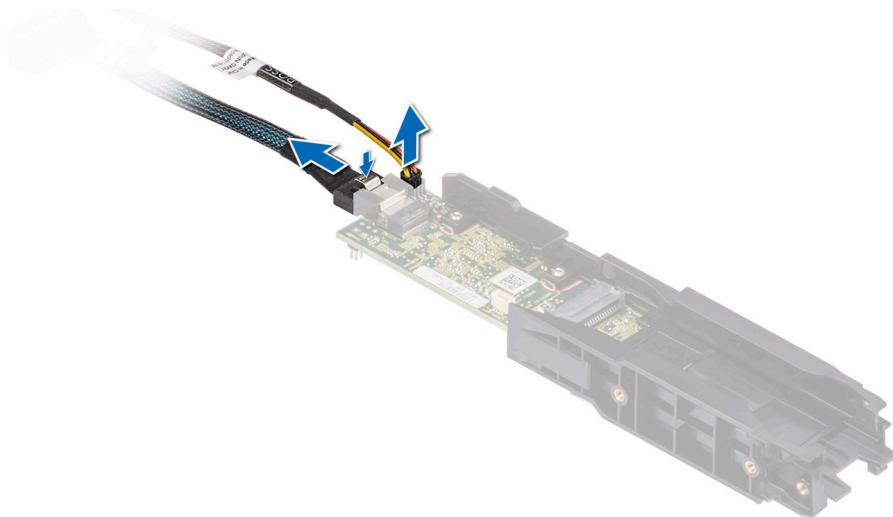

Figure 116. Removing the BOSS-N1 power and signal cable from the BOSS-N1 module

NOTE: The numbers on the image do not depict the exact steps. The numbers are for representation of sequence.

Next steps

1. [Replace the BOSS-N1 module](#) or [Install the BOSS-N1 module blank](#).

Installing the BOSS-N1 module

The procedure to install is the BOSS-N1 module with 4 x 2.5-inch rear drive module is similar.

Prerequisites

1. Follow the safety guidelines listed in the [Safety instructions](#).
2. Follow the procedure listed in the [Before working inside your system](#).
3. If installed, [remove the BOSS module blank](#).

Steps

1. Connect the BOSS-N1 power and signal cables to the connectors on the BOSS-N1 module.

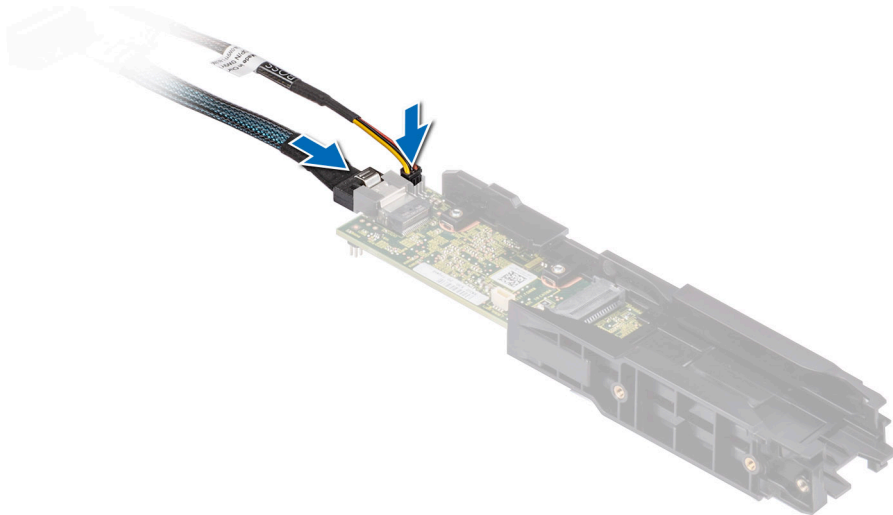

Figure 117. Connecting the BOSS-N1 power and signal cables to the BOSS-N1 module

2. Insert the BOSS-N1 module and push the module horizontally towards the rear of the system until firmly seated.
3. Using the Phillips #1 screwdriver, secure the BOSS-N1 module with the M3 x 0.5 x 4.5 mm screws.
4. Connect the BOSS-N1 power and signal cable to the connectors on the system board.

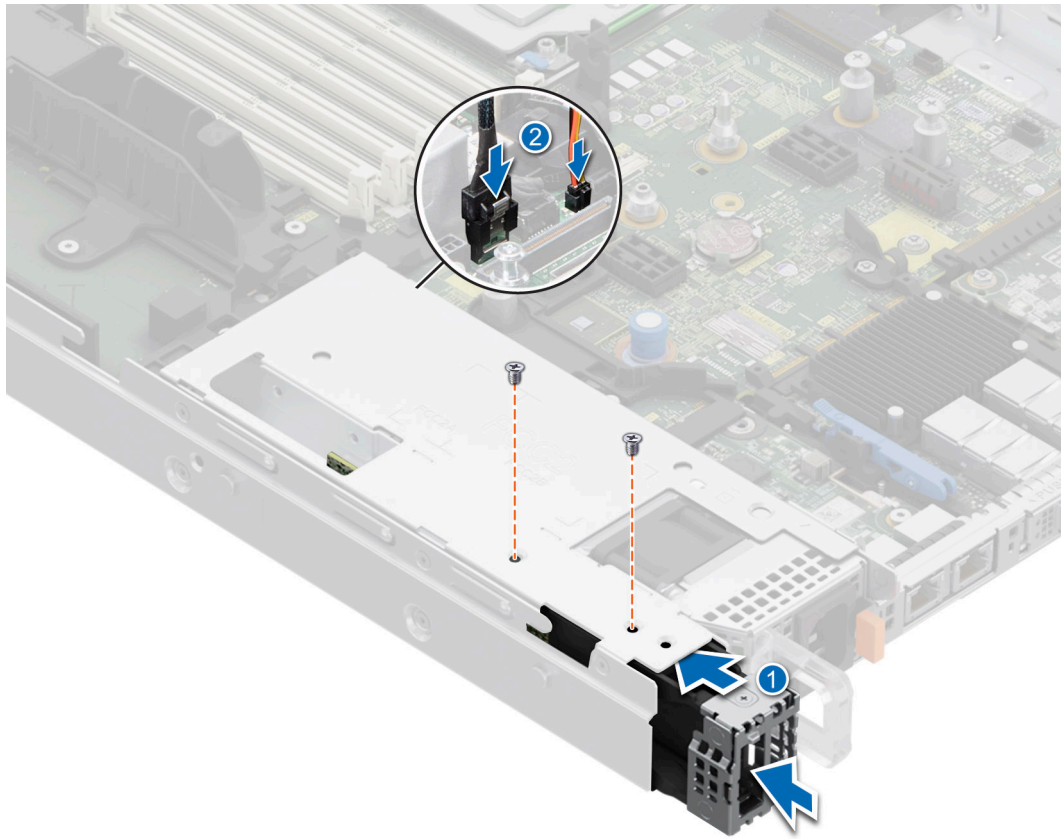

Figure 118. Installing the BOSS-N1 module

5. Align the M.2 SSD at an angle with the BOSS-N1 card carrier.
6. Insert the M.2 SSD until it is firmly seated in the BOSS-N1 card carrier.
7. Using the Phillips #1 screwdriver, secure the M.2 SSD on the BOSS-N1 card carrier with the M3 x 0.5 x 4.5 mm screw.

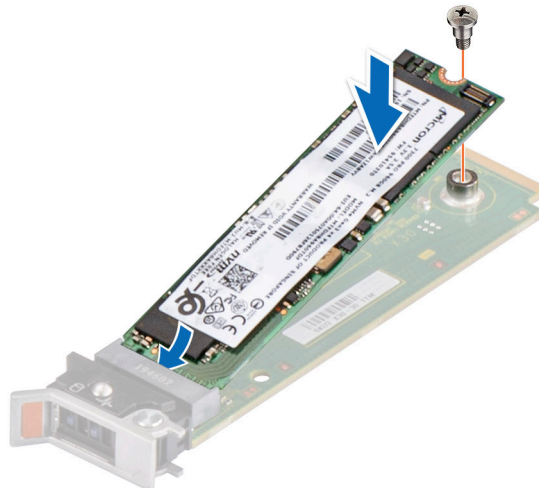

Figure 119. Installing the M.2 SSD

8. Slide the BOSS-N1 card carrier into the BOSS-N1 module slot.
9. Close the BOSS-N1 card carrier release latch to lock the carrier in place.

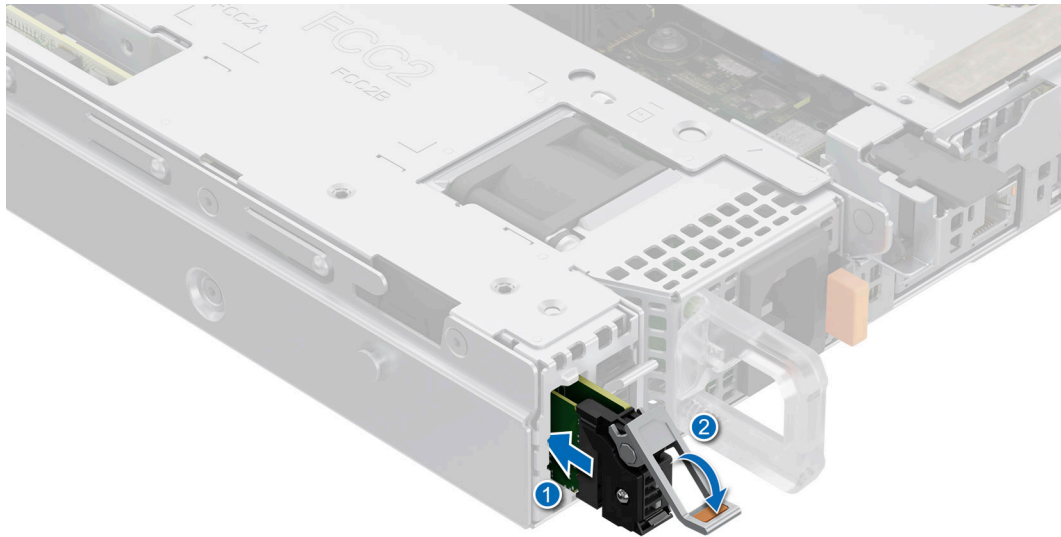

Figure 120. Installing the BOSS-N1 card carrier

NOTE: The numbers on the image do not depict the exact steps. The numbers are for representation of sequence.

Next steps

1. Follow the procedure listed in the [After working inside your system](#).

System battery

Replacing the system battery

Prerequisites

NOTE: There is a danger of a new battery exploding if it is incorrectly installed. Replace the battery only with the same or equivalent type that is recommended by the manufacturer. Discard used batteries according to the manufacturer's instructions. See the [Safety instructions](#) that came with your system for more information.

1. Follow the safety guidelines listed in the [Safety instructions](#).
2. Follow the procedure listed in the [Before working inside your system](#).
3. [Remove the air shroud](#).
4. Locate the battery socket. For more information, see the System board jumpers and connectors section.

Steps

1. Use a plastic scribe and Press the release latch until the battery pops out.

NOTE: Ensure that the + side of the battery is facing upwards.

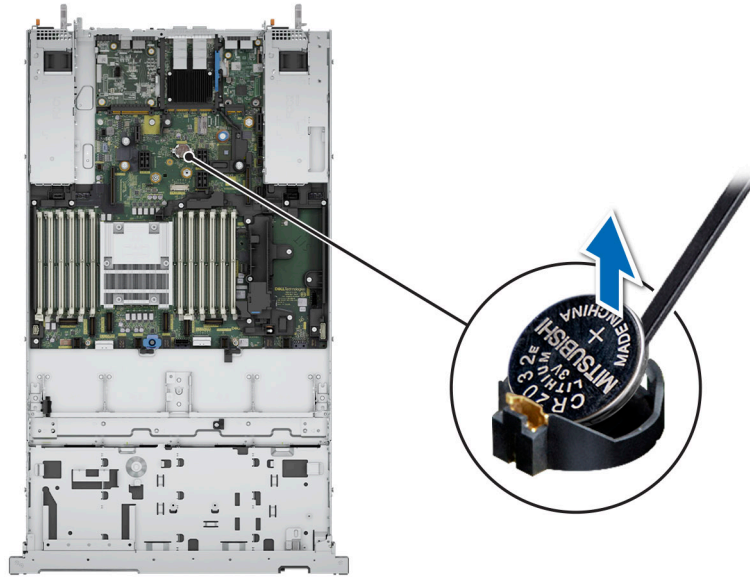

Figure 121. Removing the system battery

2. To install a system battery, press the battery into the connector until it snaps into place.
3. Insert the battery in the battery holder until the battery holder clip snaps into place.

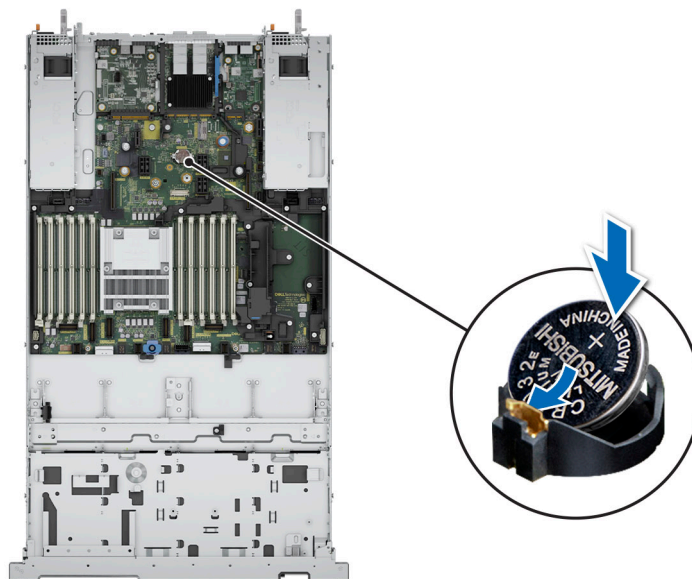

Figure 122. Installing the system battery

Next steps

1. [Install the air shroud.](#)
2. Follow the procedure listed in [After working inside your system.](#)
3. Confirm that the battery is operating properly, by performing the following steps:
 - a. Enter the System Setup, while booting, by pressing **F2**.
 - b. Enter the correct time and date in the System Setup **Time** and **Date** fields.
 - c. **Exit** the System Setup.
 - d. To test the newly installed battery, remove the system from the enclosure for at least an hour.
 - e. Reinstall the system into the enclosure after an hour.

- f. Enter the System Setup and if the time and date are still incorrect, see [Getting help](#) section.

Optional internal USB card

NOTE: To locate the internal USB port on the system board, see the [System board jumpers and connectors](#) section.

Removing the internal USB card

Prerequisites

CAUTION: To avoid interference with other components in the server, the maximum permissible dimensions of the USB memory key are 15.9 mm wide x 57.15 mm long x 7.9 mm high.

1. Follow the safety guidelines listed in the [Safety instructions](#).
2. Follow the procedure listed in the [Before working inside your system](#).
3. [Remove the expansion card risers](#).

Steps

1. Holding the blue tag, lift the internal USB card to disconnect from the connector on the system board.
2. Remove the USB memory key from the internal USB card.

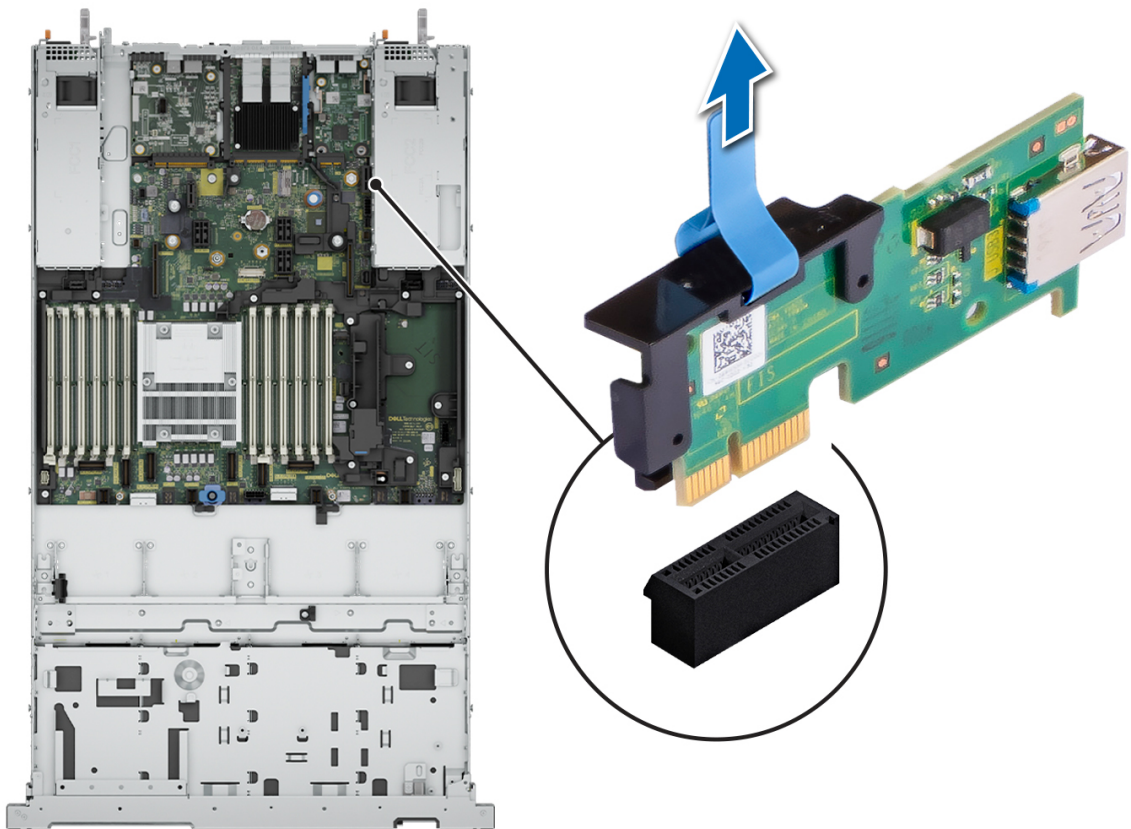

Figure 123. Removing the internal USB card

Next steps

1. [Replace the internal USB card](#).

Installing the internal USB card

Prerequisites

1. Follow the safety guidelines listed in the [Safety instructions](#).
2. Follow the procedure listed in the [Before working inside your system](#).
3. [Remove the expansion card risers](#).

Steps

1. Connect the USB key to the internal USB card.

NOTE: For information about the exact location of USB on system board, see [System board jumpers and connectors](#) section.

2. Align the internal USB card with the connector on the system board and press firmly until the internal USB card is seated. inter

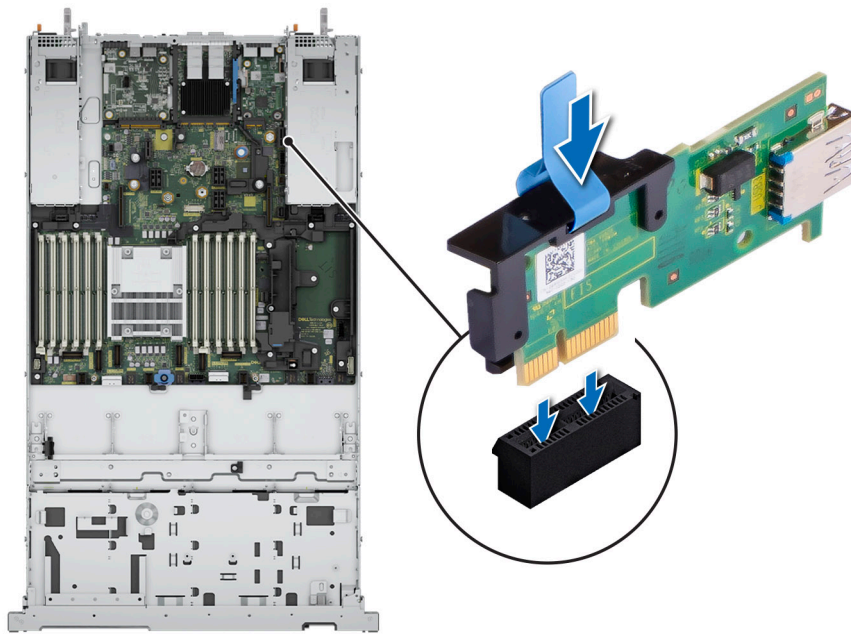

Figure 124. Installing the internal USB card

Next steps

1. [Install the expansion card risers](#).
2. Follow the procedure listed in [After working inside your system](#).
3. While booting, press F2 to enter **System Setup** and verify that the system detects the USB memory key.

Intrusion switch module

Removing the intrusion switch

Prerequisites

1. Follow the safety guidelines listed in the [Safety instructions](#).
2. Follow the procedure listed in the [Before working inside your system](#).
3. [Remove the air shroud](#).
4. Keep the plastic scribe ready.

Steps

1. Disconnect and remove the intrusion switch cable connector from connector on the system board.
NOTE: Observe the routing of the cable as you remove it from the system.
2. Using a Phillips #2 screwdriver, remove the screw that secures the intrusion switch on the intrusion switch slot.
3. Lift to remove the intrusion switch out of the intrusion switch slot.

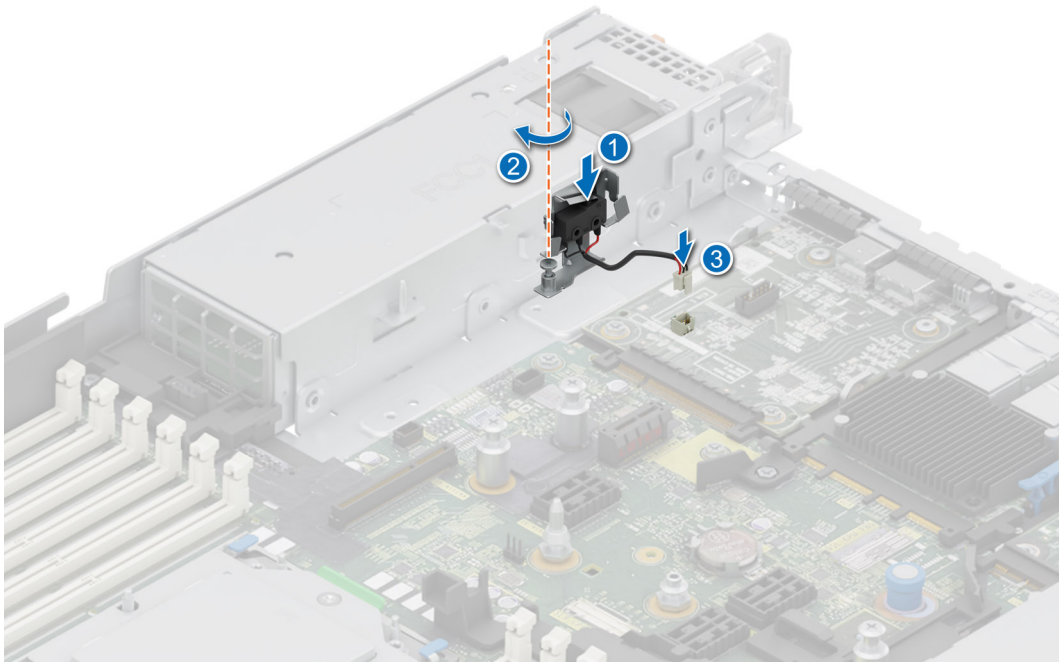

Figure 125. Removing the intrusion switch

Next steps

1. [Replace the intrusion switch.](#)

Installing the intrusion switch

Prerequisites

1. Follow the safety guidelines listed in the [Safety instructions](#).
2. Follow the procedure listed in the [Before working inside your system](#).
3. [Remove the air shroud.](#)

Steps

1. Align and insert the intrusion switch in the slot until it is firmly seated in the slot on the system.
NOTE: Route the cable properly when you replace it to prevent the cable from being pinched or crimped.
2. Using a Phillips #2 screwdriver, tighten the screw that secures the intrusion switch on the intrusion switch slot.
3. Connect the intrusion switch cable to the connector on the system board.

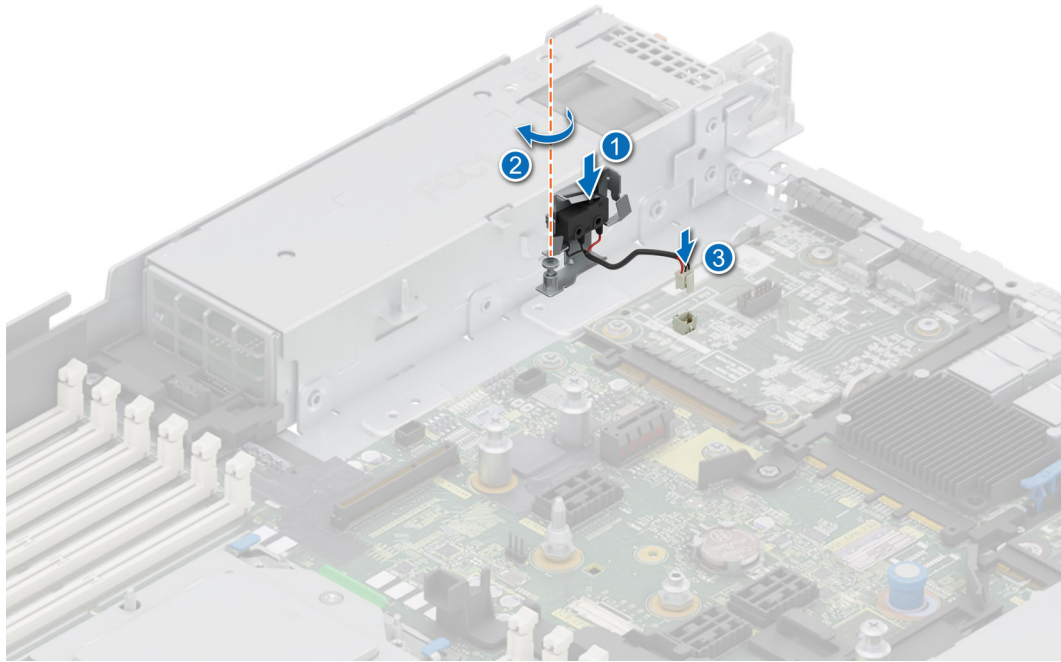

Figure 126. Installing the intrusion switch

Next steps

1. [Install the air shroud.](#)
2. Follow the procedure listed in [After working inside your system.](#)

Optional OCP card

Removing the OCP card

Prerequisites

1. Follow the safety guidelines listed in the [Safety instructions.](#)
2. Follow the procedure listed in the [Before working inside your system.](#)
3. [Remove the expansion card riser.](#)

Steps

1. Open the blue latch to disengage the OCP card.
2. Push the OCP card towards the rear end of the system to disconnect from the connector on the system board.
3. Slide the OCP card out of the slot on the system.

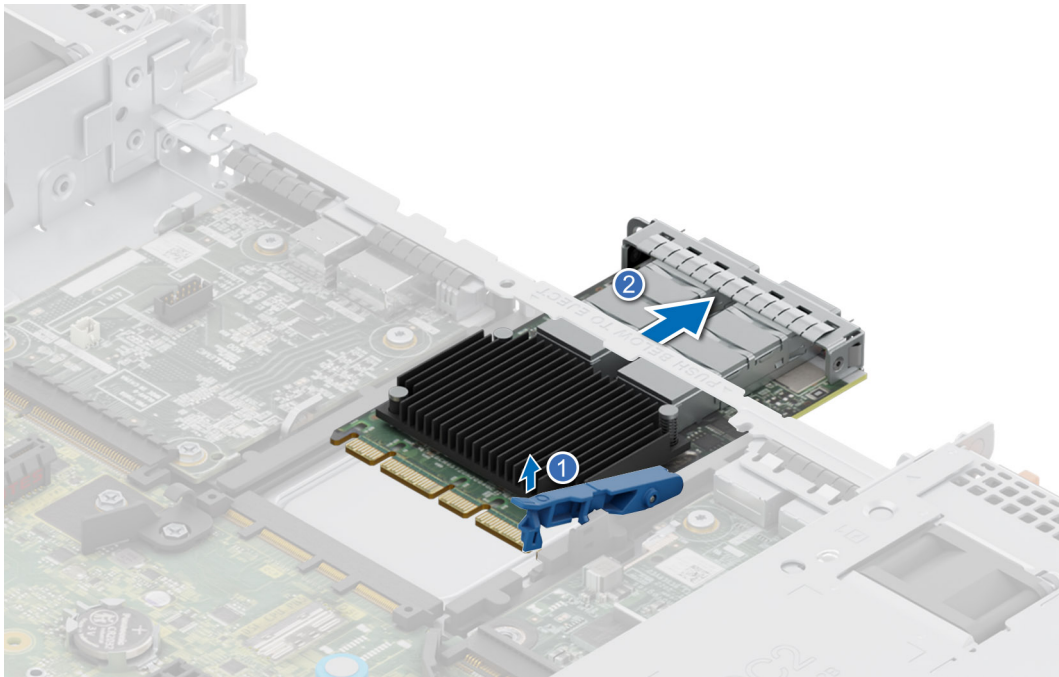

Figure 127. Removing the OCP card

Next steps

1. [Replace the OCP card.](#)

Installing the OCP card

Prerequisites

1. Follow the safety guidelines listed in the [Safety instructions](#).
2. Follow the procedure listed in the [Before working inside your system](#).
3. [Remove the expansion card riser](#).

CAUTION: Do not install GPUs, network cards, or other PCIe devices on your system that are not validated and tested by Dell. Damage caused by unauthorized and invalidated hardware installation will null and void the system warranty.

Steps

1. If installed, remove the filler bracket.
2. Open the blue latch on the system board.
3. Slide the OCP card into the slot in the system.
4. Push until the OCP card is connected to the connector on the system board.
5. Close the blue latch to lock the OCP card to the system.

NOTE: The numbers on the image do not depict the exact steps. The numbers are for representation of sequence.

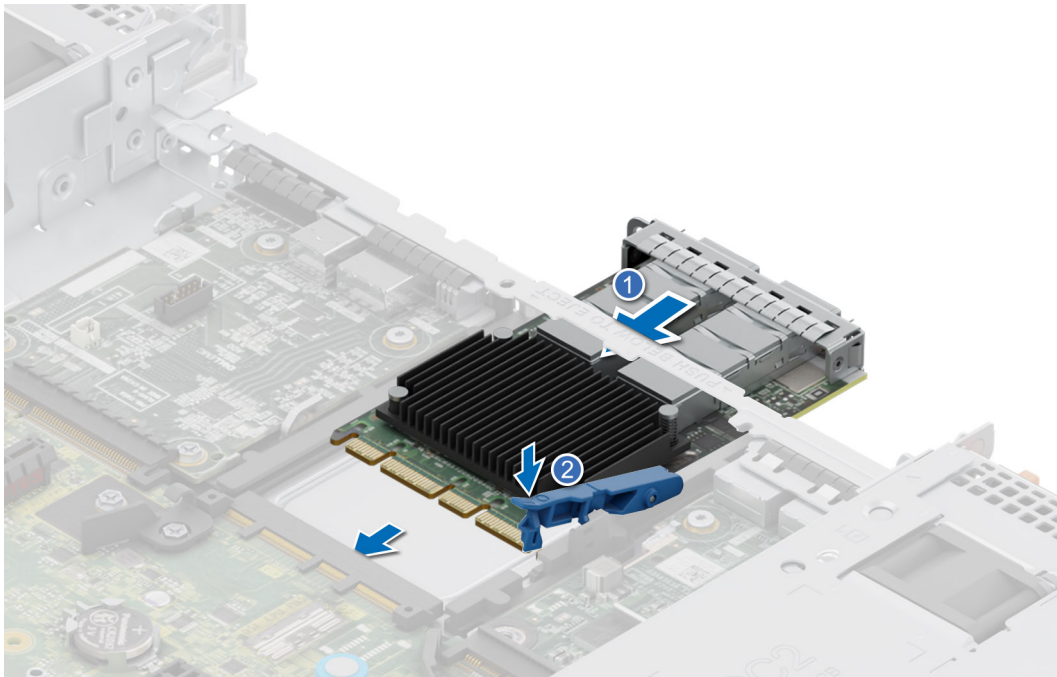

Figure 128. Installing the OCP card

Next steps

1. [Install the expansion card riser.](#)
2. Follow the procedure listed in [After working inside your system.](#)

Control panel

This is a service technician replaceable part only.

Removing the right control panel

Prerequisites

1. Follow the safety guidelines listed in the [Safety instructions.](#)
2. Follow the procedure listed in the [Before working inside your system.](#)
3. [Remove the drive backplane cover.](#)
4. If installed, [remove the air shroud.](#)
5. [Remove the cooling fan.](#)
6. [Remove the side wall bracket.](#)

Steps

1. Remove the cable cover away from the system.
2. Using the Phillips #1 screwdriver, remove the screws that secure the right control panel and cable cover to the system.
3. Disconnect the right control panel cable from the connectors on the system board.
4. Holding the right control panel assembly, slide the right control panel out of the system.

i **NOTE:** Observe the routing of the cable assembly as you remove the right control panel from the system.

i **NOTE:** The numbers on the image do not depict the exact steps. The numbers are for representation of sequence.

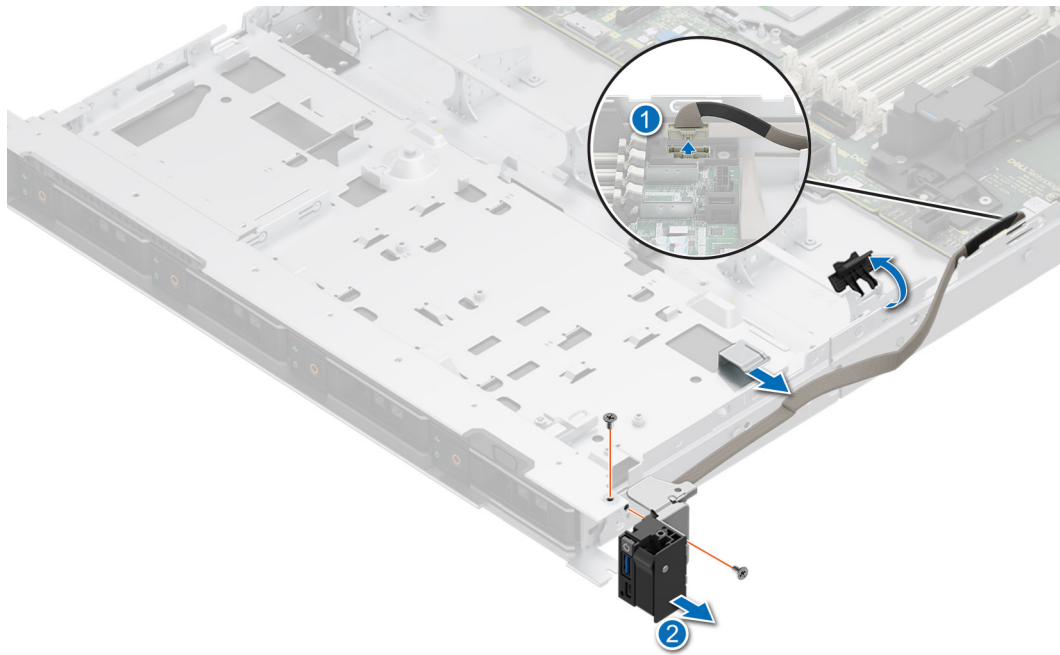

Figure 129. Removing the right control panel

Next steps

1. [Replace the right control panel.](#)

Installing the right control panel

Prerequisites

1. Follow the safety guidelines listed in the [Safety instructions](#).
2. Follow the procedure listed in the [Before working inside your system](#).
3. [Remove the drive backplane cover.](#)
4. If installed, [remove the air shroud.](#)
5. [Remove the cooling fan.](#)
6. [Remove the side wall bracket.](#)

Steps

1. Align and slide the right control panel into the slot on the system.
2. Connect the right control panel cable to the connectors on the system board.
3. Route the right control panel cable through the side wall of the system.
4. Align and slide the right control panel cable cover in the slot on the system.
 - ① **NOTE:** Route the cable properly to prevent the cable from being pinched or crimped.
5. Using the Phillips #1 screwdriver, tighten the screws that secure the right control panel and the cable cover to the system.
 - ① **NOTE:** The numbers on the image do not depict the exact steps. The numbers are for representation of sequence.

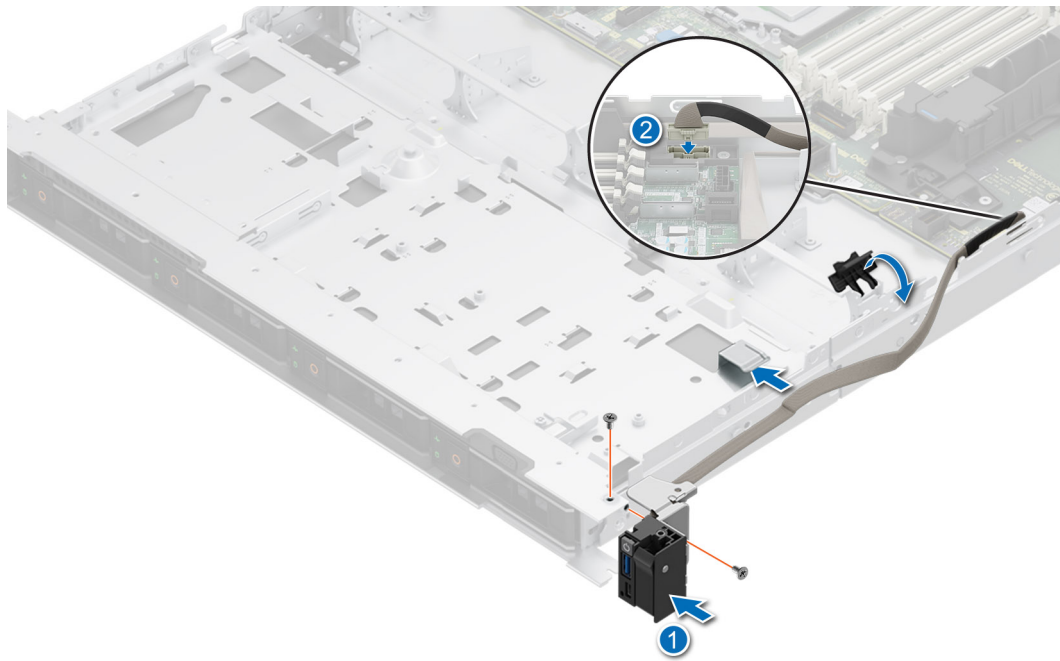

Figure 130. Installing the right control panel

Next steps

1. [Install the side wall bracket.](#)
2. [Install the cooling fan.](#)
3. [Install the drive backplane cover.](#)
4. If removed, [install the air shroud.](#)
5. Follow the procedure listed in [After working inside your system.](#)

Removing the left control panel

Prerequisites

1. Follow the safety guidelines listed in the [Safety instructions.](#)
2. Follow the procedure listed in the [Before working inside your system.](#)
3. [Remove the drive backplane cover.](#)
4. If installed, [remove the air shroud.](#)
5. [Remove the cooling fan.](#)
6. [Remove the side wall bracket.](#)

Steps

1. Disconnect the control panel cable from the connector on the system board.
2. Remove the cable from the wall bracket.
3. Using the Phillips #1 screwdriver, remove the screws that secure the left control panel and the cable cover to the system.
4. Holding the cable, slide the left control panel out of the system.

NOTE: Observe the routing of the cable as you remove the right control panel from the system.

NOTE: The numbers on the image do not depict the exact steps. The numbers are for representation of sequence.

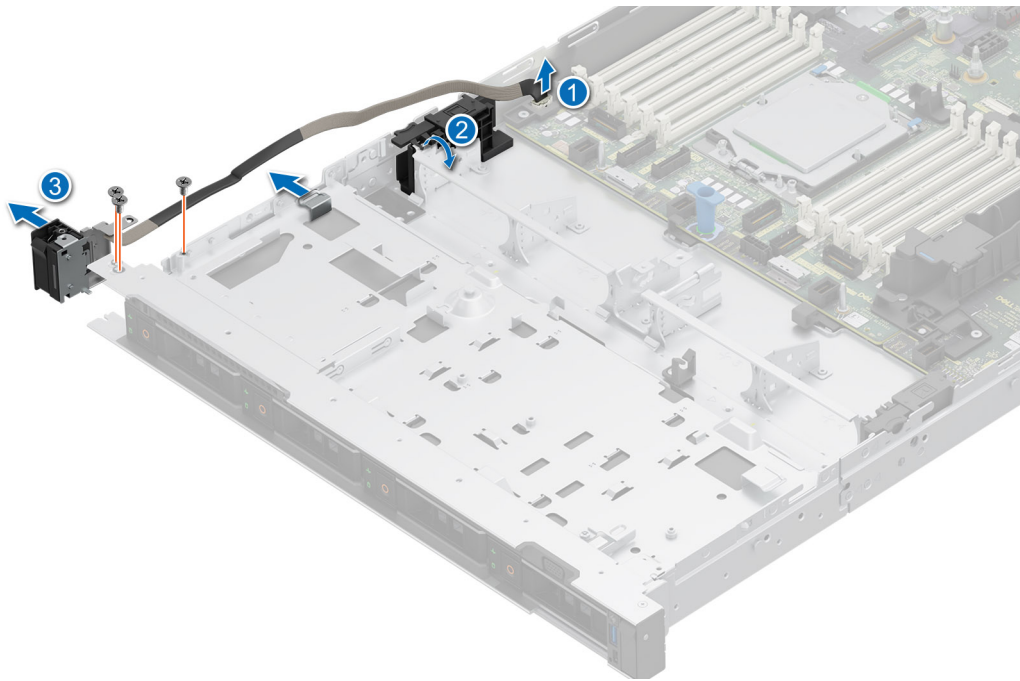

Figure 131. Removing the left control panel

Next steps

1. [Replace the left control panel.](#)

Installing the left control panel

Prerequisites

1. Follow the safety guidelines listed in the [Safety instructions](#).
2. Follow the procedure listed in the [Before working inside your system](#).
3. [Remove the drive backplane cover.](#)
4. If installed, [remove the air shroud.](#)
5. [Remove the cooling fan.](#)
6. [Remove the side wall bracket.](#)

Steps

1. Align and slide the left control panel in the slot on the system.
2. Route the left control panel cable through the side wall of the system.
3. Connect the left control panel cable to the connector on the system board .
4. Align and slide the left control panel cable cover in the slot on the system.
i **NOTE:** Route the cable properly to prevent the cable from being pinched or crimped.
5. Using the Phillips #1 screwdriver, tighten the screws to secure the left control panel and the cable cover to the system.
i **NOTE:** The numbers on the image do not depict the exact steps. The numbers are for representation of sequence.

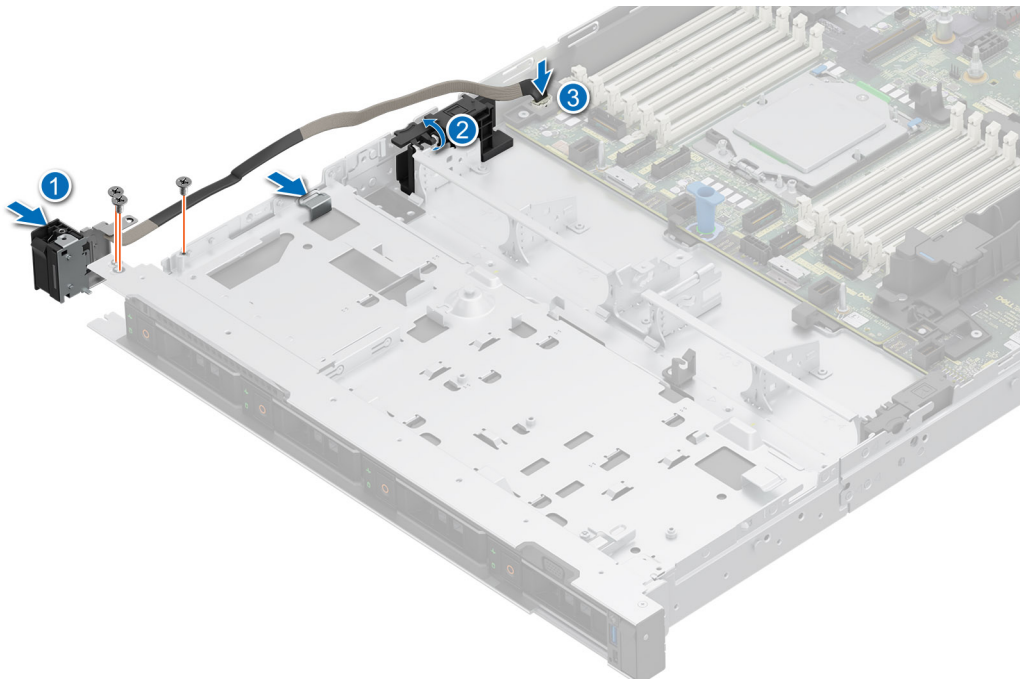

Figure 132. Installing the left control panel

Next steps

1. Install the side wall bracket.
2. Install the cooling fan.
3. Install the drive backplane cover.
4. If removed, install the air shroud.
5. Follow the procedure listed in [After working inside your system](#).

Power supply unit

NOTE: While replacing the hot swappable PSU, after next server boot; the new PSU automatically updates to the same firmware and configuration of the replaced one. For more information about the Part replacement configuration, see the *Lifecycle Controller User's Guide* at <https://www.dell.com/idracmanuals>

Hot spare feature

Your system supports the hot spare feature that significantly reduces the power overhead associated with power supply unit (PSU) redundancy.

When the hot spare feature is enabled, one of the redundant PSUs is switched to the sleep state. The active PSU supports 100 percent of the system load, thus operating at higher efficiency. The PSU in the sleep state monitors output voltage of the active PSU. If the output voltage of the active PSU drops, the PSU in the sleep state returns to an active output state.

If having both PSUs active is more efficient than having one PSU in the sleep state, the active PSU can also activate the sleeping PSU.

The default PSU settings are as follows:

- If the load on the active PSU is more than 50 percent of PSU rated power wattage, then the redundant PSU is switched to the active state.
- If the load on the active PSU falls below 20 percent of PSU rated power wattage, then the redundant PSU is switched to the sleep state.

You can configure the hot spare feature by using the iDRAC settings. For more information, see the *iDRAC User's Guide* available at www.dell.com/poweredgemanuals.

Removing a power supply unit blank

Prerequisites

Follow the safety guidelines listed in the [Safety instructions](#).

Steps

Pull the blank out of the system.

CAUTION: To ensure proper system cooling, the PSU blank must be installed in the second PSU bay in a non-redundant configuration. Remove the PSU blank only if you are installing a second PSU.



Figure 133. Removing a power supply unit blank

Next steps

1. [Replace the PSU blank](#) or [install the PSU](#).

Installing a power supply unit blank

Prerequisites

1. Follow the safety guidelines listed in the [Safety Instructions](#).
NOTE: Install the power supply unit (PSU) blank only in the second PSU bay.
2. If required, [Remove the PSU](#).

Steps

Align the PSU blank with the PSU bay and push it into the PSU bay until it clicks into place.

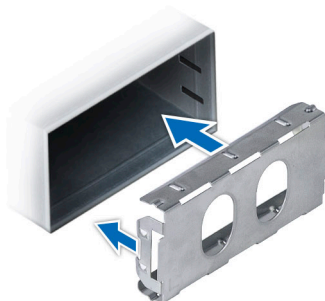

Figure 134. Installing a power supply unit blank

Removing a power supply unit

Prerequisites

CAUTION: The system requires one power supply unit (PSU) for normal operation. On power-redundant systems, remove and replace only one PSU at a time in a system that is powered on.

1. Follow the safety guidelines listed in the [Safety instructions](#).
2. Disconnect the power cable from the power outlet and from the PSU that you intend to remove.
3. Remove the cable from the strap on the PSU handle.
4. Unlatch and lift or remove the optional cable management accessory if it interferes with the PSU removal.

NOTE: For information about the cable management when the PSU is removed or installed while the system is in a rack, see the system's cable management arm documentation at <https://www.dell.com/poweredgemanuals>.

Steps

Press the release latch and holding the PSU handle, slide the PSU out of the bay.

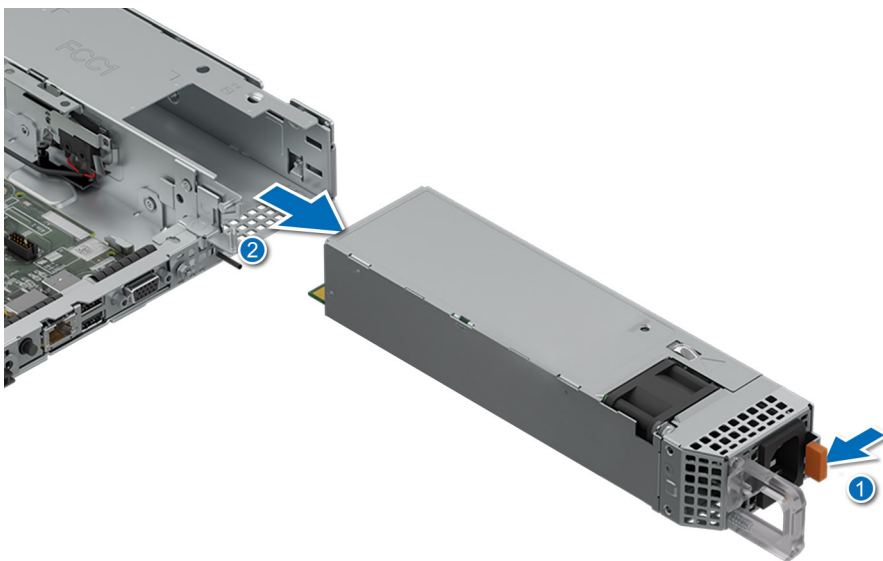

Figure 135. Removing a power supply unit

Next steps

1. [Replace the PSU](#) or [install the PSU blank](#).

Installing a power supply unit

Prerequisites

1. Follow the safety guidelines listed in the [Safety instructions](#).
2. For systems that support redundant PSU, ensure that both the PSUs are of the same type and have the same maximum output power.

NOTE: The maximum output power (shown in watts) is listed on the PSU label.

3. If required, [Remove the PSU blank](#).

Steps

Slide the PSU into the PSU bay until the release latch snaps into place.

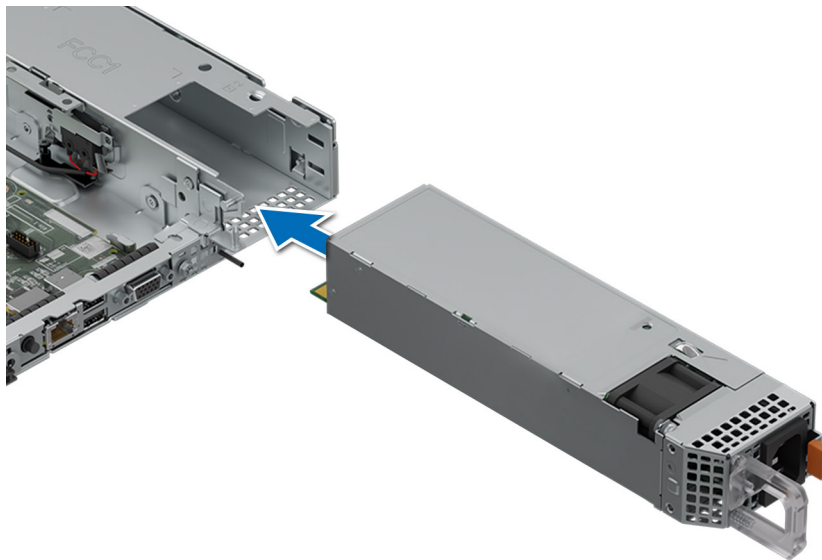

Figure 136. Installing a power supply unit

Next steps

1. If you have unlatched or removed the cable management accessory, reinstall or relatch it. For information about the cable management when the PSU is removed or installed while the system is in the rack, see the system's cable management accessory documentation at <https://www.dell.com/poweredgemanuals>.
2. Connect the power cable to the PSU, and plug the cable into a power outlet.

CAUTION: When connecting the power cable to the PSU, secure the cable to the PSU with the strap.

NOTE: When installing hot swapping, or hot adding a new PSU, wait for 15 seconds for the system to recognize the PSU and determine its status. The PSU redundancy may not occur until discovery is complete. The PSU status indicator turns green to indicate that the PSU is functioning properly.

Trusted Platform Module

Upgrading the Trusted Platform Module

Removing the TPM

Prerequisites

1. Follow the safety guidelines listed in the [Safety instructions](#).
2. Follow the procedure listed in the [Before working inside your system](#).

NOTE:

- Ensure the operating system is compatible with the TPM version you are installing.
- Ensure that you download and install the latest BIOS firmware on your system.
- Ensure that the BIOS is configured to enable UEFI boot mode.

CAUTION: The TPM plug-in module is cryptographically bound to that particular system board after it is installed. When the system is powered on, any attempt to remove an installed TPM plug-in module breaks the cryptographic binding, and the removed TPM cannot be installed on another system board. Ensure any keys you have stored on the TPM have been securely transferred.

Steps

1. Locate the TPM connector on the system board. For more information, see [system board connectors](#).
2. Press to hold the module down and remove the screw using the security Torx 8-bit shipped with the TPM module.
3. Slide the TPM module out from its connector.
4. Push the plastic rivet away from the TPM connector and rotate it 90° counterclockwise to release it from the system board.
5. Pull the plastic rivet out of its slot on the system board.

Installing the TPM

Prerequisites

1. Follow the safety guidelines listed in the [Safety instructions](#).
2. Follow the procedure listed in the [Before working inside your system](#).

Steps

1. To install the TPM, align the edge connectors on the TPM with the slot on the TPM connector.
2. Insert the TPM into the TPM connector such that the plastic rivet aligns with the slot on the system board.
3. Press the plastic rivet until the rivet snaps into place.
4. Replace the screw that secures the TPM to the system board.

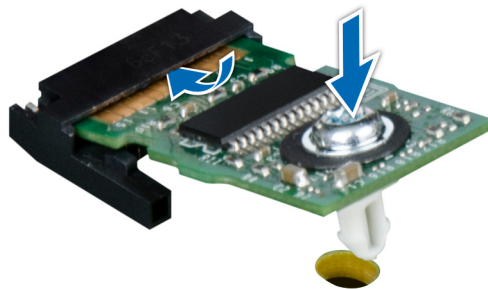

Figure 137. Installing the TPM

Initializing TPM for users

Steps

1. Initialize the TPM.
For more information, see [Initializing the TPM for users](#).
2. The **TPM Status** changes to **Enabled, Activated**.

Initializing the TPM 1.2 for users

Steps

1. While booting your system, press F2 to enter System Setup.
2. On the **System Setup Main Menu** screen, click **System BIOS > System Security Settings**.
3. From the **TPM Security** option, select **On with Preboot Measurements**.
4. From the **TPM Command** option, select **Activate**.
5. Save the settings.
6. Restart your system.

Initializing the TPM 2.0 for users

Steps

1. While booting your system, press F2 to enter System Setup.
2. On the **System Setup Main Menu** screen, click **System BIOS > System Security Settings**.
3. From the **TPM Security** option, select **On**.
4. Save the settings.
5. Restart your system.

System board

Removing the system board

Prerequisites

 **CAUTION:** If you are using the Trusted Platform Module (TPM) with an encryption key, you may be prompted to create a recovery key during program or System Setup. Be sure to create and safely store this recovery key. If you replace this system board, you must supply the recovery key when you restart your system or program before you can access the encrypted data on your drives.

1. Follow the safety guidelines listed in the [Safety instructions](#).
2. Follow the procedure listed in the [Before working inside your system](#).
3. Remove the following components:
 - a. [Air shroud](#)
 - b. [Cooling fan](#)
 - c. [Side wall bracket](#)
 - d. [Memory modules](#)
 - e. [Serial COM port \(if installed\)](#)
 - f. [VGA port \(if installed\)](#)
 - g. [Expansion card risers](#)
 - h. [Rear drive module](#)
 - i. [Processor and heat sink module](#)
 - j. [BOSS-N1 module](#)
 - k. [Internal USB card \(if installed\)](#)
 - l. [OCP card \(if installed\)](#)
 - m. [LOM card \(if installed\)](#)
 - n. [Power supply units \(PSU\)](#)
 - o. Disconnect all the cables from the system board and make note of all the cable connections.

 **CAUTION:** Take care not to damage the system identification button while removing the system board from the system.

 **CAUTION:** Do not lift the system board by holding a memory module, processor, or other components.

Steps

1. Using the system board holder and plunger, slide the system board towards the front of the system.
2. At a tilted angle, lift the system board out of the chassis.

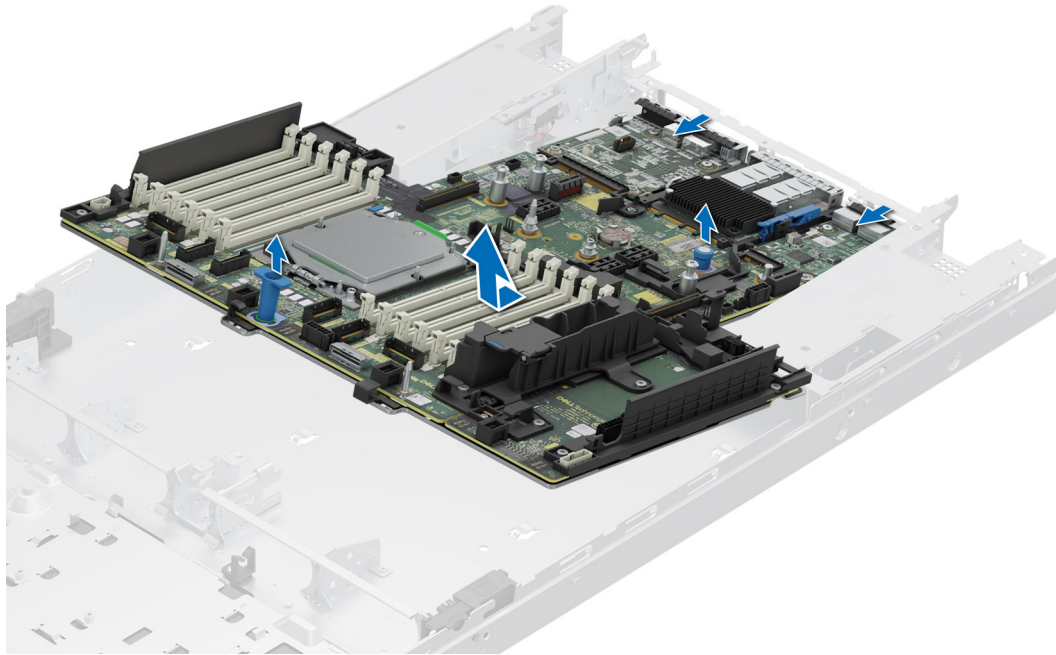

Figure 138. Removing the system board

Next steps

1. [Install the system board.](#)

Installing the system board

Prerequisites

i **NOTE:** Before replacing the system board, replace the old iDRAC MAC address label in the Information tag with the iDRAC MAC address label of the replacement system board.

1. Follow the safety guidelines listed in the [Safety instructions](#).
2. Follow the procedure listed in the [Before working inside your system](#).
3. If you are replacing the system board, remove all the components that are listed in the removing the system board section.

Steps

1. Unpack the new system board assembly.

⚠ CAUTION: Do not lift the system board by holding a memory module, processor, or other components.

⚠ CAUTION: Take care not to damage the system identification button while placing the system board into the chassis.

2. Holding the system board holder and plunger, lower the system board at a tilted angle into the system.
3. Slide the system board towards the rear of the chassis until the connectors are firmly seated in the slots.

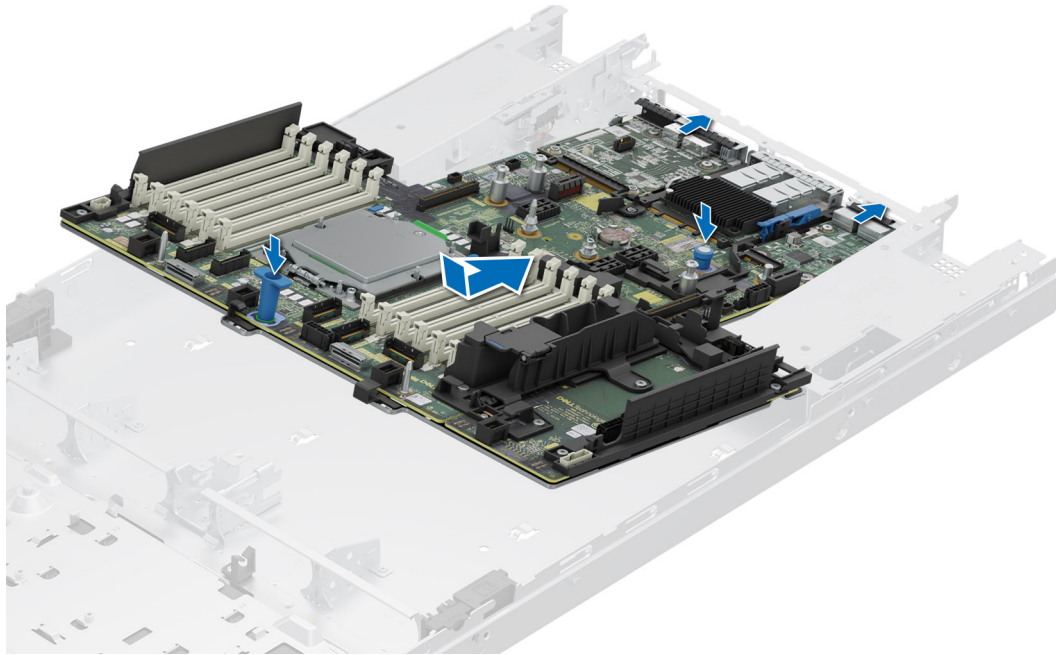

Figure 139. Installing the system board

Next steps

1. Replace the following components:
 - a. [Trusted Platform Module \(TPM\)](#)
 - i** **NOTE:** The TPM Module must be replaced only while installing new system board.
 - b. [Internal USB card \(if removed\)](#)
 - c. [OCP card \(if removed\)](#)
 - d. [LOM card \(if removed\)](#)
 - e. [Processor and heat sink module](#)
 - f. [Memory modules](#)
 - g. [Expansion card risers](#)
 - h. [Rear drive module](#)
 - i. [VGA port \(if removed\)](#)
 - j. [Serial COM port \(if removed\)](#)
 - k. [BOSS-N1 module](#)
 - l. [Side wall bracket](#)
 - m. [Cooling fan](#)
 - n. [Air shroud](#)
 - o. [Power supply units \(PSU\)](#)
2. Reconnect all cables to the system board.
 - i** **NOTE:** Ensure that the cables inside the system are routed along the chassis wall and secured using the cable securing bracket.
3. Ensure that you perform the following steps:
 - a. Use the Easy Restore feature to restore the Service Tag. See the [Restoring the system by using the Easy Restore feature](#) section.
 - b. If the service tag is not backed up in the backup flash device, enter the system service tag manually. See the [Manually update the Service Tag](#) by using System Setup section.
 - c. Update the BIOS and iDRAC versions.
 - d. Re-enable the Trusted Platform Module (TPM). See the [Upgrading the Trusted Platform Module](#) section.
4. If you are not using Easy Restore, import your new or existing iDRAC Enterprise license. For more information, see the *Integrated Dell Remote Access Controller User's Guide* available at <https://www.dell.com/idracmanuals>.
5. Follow the procedure listed in [After working inside your system](#).

Restoring Service Tag using Easy Restore

The Easy Restore feature allows you to restore your Service Tag, iDRAC license, UEFI configuration, and the system configuration data after replacing the system board. All data is backed up in a backup Flash drive device automatically. If BIOS detects a new system board, and the Service Tag in the backup Flash drive device is different, BIOS prompts the user to restore the backup information.

About this task

Below is a list of options available:

1. Restore the service tag, license, and diagnostics information, press **Y**
 2. Navigate to the Lifecycle Controller based restore options, press **N**
 3. Restore data from a previously created **Hardware Server Profile**, press **F10**
i **NOTE:** When the restore process is complete, BIOS prompts to restore the system configuration data.
 4. Restore data from a previously created **Hardware Server Profile**, press **F10**
 5. To restore the system configuration data, press **Y**
 6. To use the default configuration settings, press **N**
i **NOTE:** After the restore process is complete, system reboots.
- i** **NOTE:** If restoring the Service Tag is successful, you can check the Service Tag information in the **System Information** screen and compare it with the Service Tag on the system.

Manually update the Service Tag

After replacing a system board, if Easy Restore fails, follow this process to manually enter the Service Tag, using **System Setup**.

About this task

If you know the system service tag, use the **System Setup** menu to enter the service tag.

Steps

1. Power on the system.
2. To enter the **System Setup**, press **F2**.
3. Click **Service Tag Settings**.
4. Enter the service tag.
i **NOTE:** You can enter the service tag only when the **Service Tag** field is empty. Ensure that you enter the correct service tag. Once the service tag is entered, it cannot be updated or changed. Incorrectly entered service tag will lead to system board replacement.
5. Click **OK**.

LOM card and rear I/O board

Removing the LOM card and rear I/O board

Prerequisites

1. Follow the safety guidelines listed in the [Safety instructions](#).
2. Follow the procedure listed in the [Before working inside your system](#).
3. [Remove the system board](#).
i **NOTE:** The procedure to remove the liquid cooling rear I/O board and rear I/O boards is same.

Steps

1. Using a Phillips # 2 screwdriver, remove the screws that secure the LAN on Motherboard (LOM) card and rear I/O board to the system board.
2. Holding the edges, pull the LOM card or rear I/O board to disconnect from the connector on the system board.

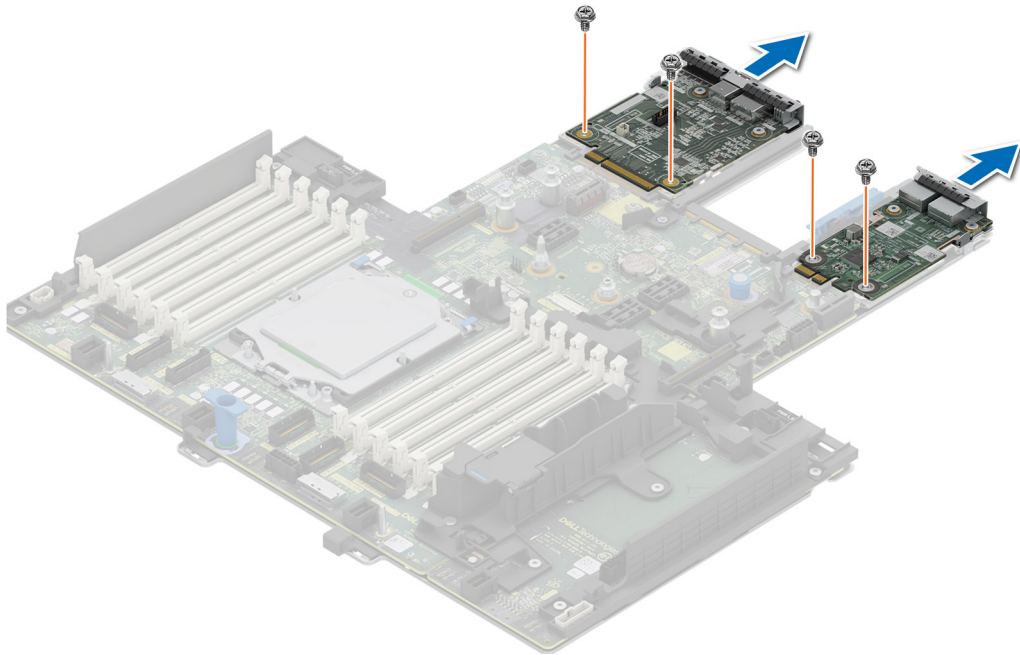

Figure 140. Removing the LOM card and rear I/O board

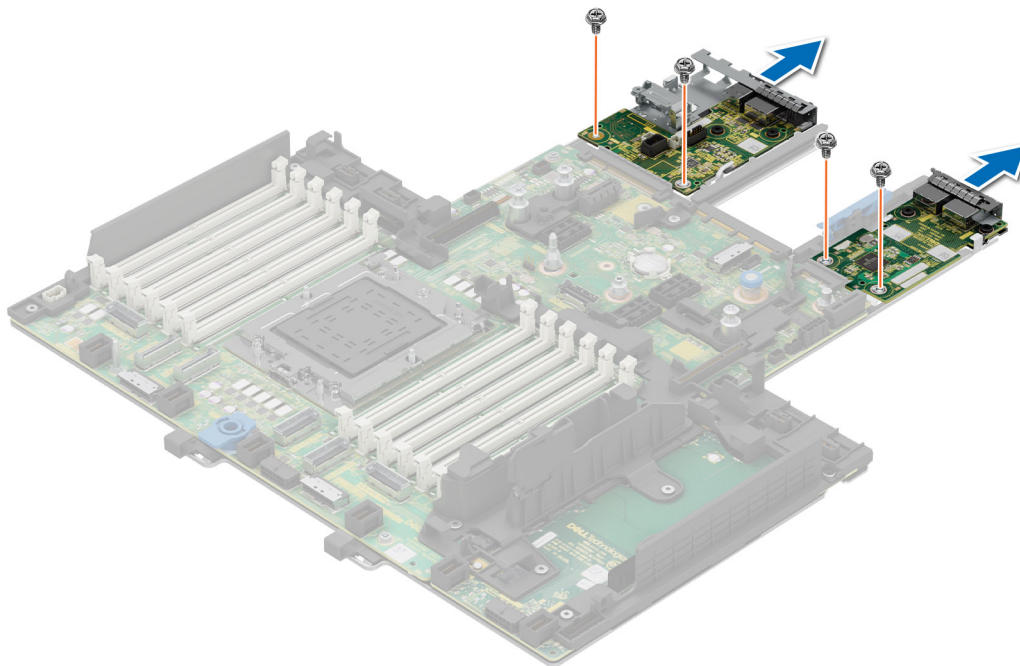

Figure 141. Removing the LOM card and liquid cooling rear I/O board

Next steps

1. Replace the LOM card and rear I/O board.

Installing the LOM card and rear I/O board

Prerequisites

1. Follow the safety guidelines listed in the [Safety instructions](#).
2. Follow the procedure listed in the [Before working inside your system](#).
3. [Remove the system board](#).

i **NOTE:** The procedure to install the liquid cooling rear I/O board and rear I/O boards is same.

Steps

1. Align the connectors and slots on the LOM card or rear I/O board with the connector and standoffs on the system board.
2. Press the LOM card or rear I/O board until firmly seated on the system board connector.
3. Using a Phillips #2 screwdriver, secure the LOM card or rear I/O board to the system board with screws.

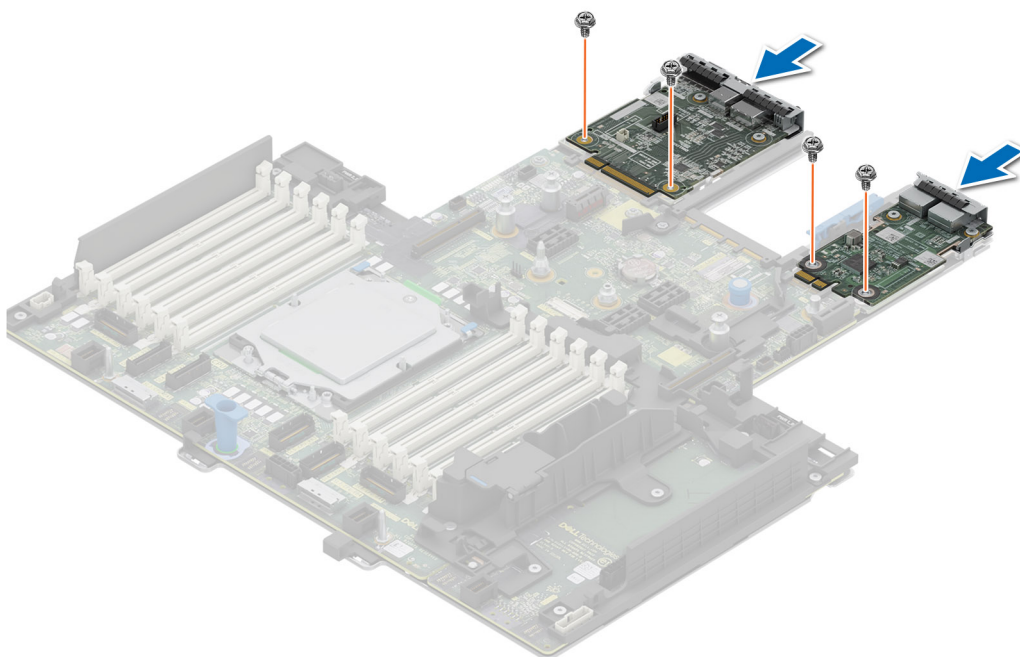

Figure 142. Installing the LOM card and rear I/O board

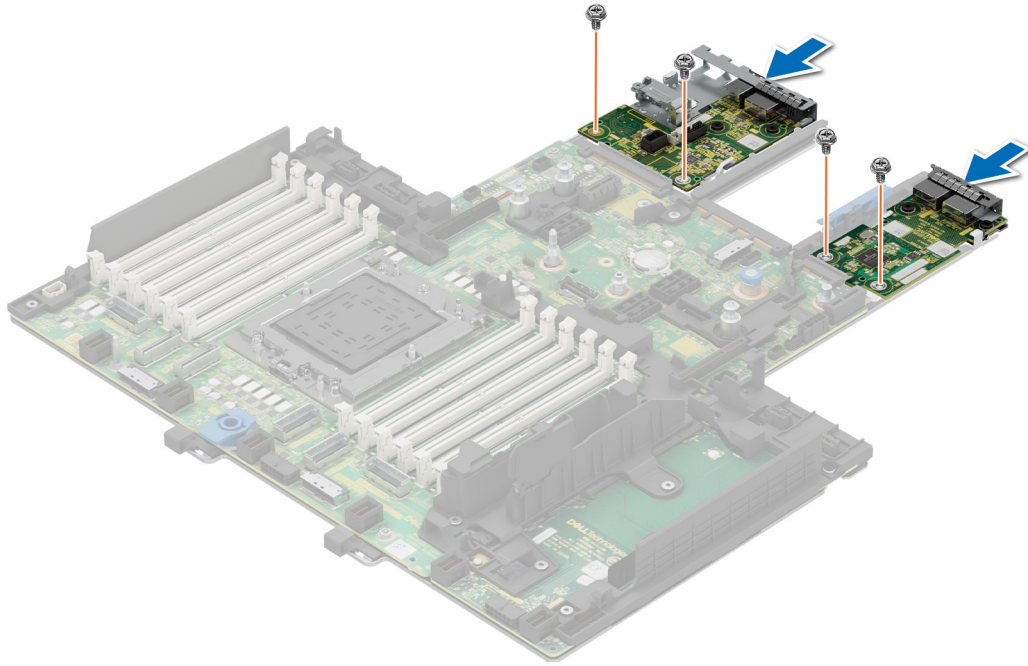

Figure 143. Installing the LOM card and Liquid cooling rear I/O board

Next steps

1. [Install the system board.](#)
2. Follow the procedure listed in [After working inside your system.](#)

Upgrade Kits

The table lists the available After Point Of Sale [APOS] kits.

Table 91. Upgrade kits

| Kits | Related links to service instructions |
|---|---|
| Bezel | See Installing the front bezel |
| M.2 SSD | See Installing the M.2 SSD module |
| BOSS-N1 | See Installing the BOSS-N1 controller card module |
| Drives | See Installing the drive |
| Memory | See Installing a memory module |
| Network cards (Standard PCIe adapter LP/FH) | See Installing the LOM card and rear I/O board |
| Network cards (OCP) | See Installing the OCP card |
| PCIe SSD card | See Installing the drive |
| Power cords | N/A |
| Power supplies | See Installing a power supply unit |
| Quick sync | N/A |
| TPM | See Upgrading the Trusted Platform Module |
| Processor enablement thermal kits | See Installing the processor |
| Internal USB 3.0 card | See Internal USB card kit |
| Serial COM port daughter card | See Installing the serial COM port |
| VGA port for Direct Liquid Cooling system | See Installing the VGA port |
| Cables | N/A |
| Fans | See Installing a fan |
| Heat sink | See Installing a processor heat sink module or Direct Liquid Cooling Module |
| Risers | See Installing the expansion riser |
| Rail | N/A |
| CMA | N/A |

Topics:

- [BOSS-N1 module kit](#)
- [Data Processing Unit \(DPU\) kit](#)

BOSS-N1 module kit

The BOSS-N1 module supports up to two M.2 SSDs.

NOTE: To enable the BOSS-N1 module in the system, ensure that the BIOS firmware version is 1.5.5 and iDRAC firmware version is 4.30.30.30 or later.

Before you begin the installation or removal process, follow the [Safety instructions](#) and [Before working inside your system instructions](#).

Table 92. BOSS-N1 module kit components

| R660 (quantity) | Components in kit |
|-----------------|------------------------------|
| NA | BOSS cover |
| 1 | M3 x 0.05 x 4.5 mm screws |
| 1 | BOSS signal cable |
| 1 | BOSS power cable |
| 1 | BOSS-N1 module |
| 1 or 2 | BOSS-N1 card carrier |
| 1 or 2 | M.2 SSD |
| 2 | M.2 480 GB information label |
| 2 | M.2 960 GB information label |
| 1 | BOSS card filler |
| 1 | Tech sheet |

To remove the BOSS blank :

1. Power off the system and [remove the system cover](#).
2. Using a Phillips #1 screwdriver, remove the screw that secures the BOSS-N1 module bay to the chassis.
3. Remove the blank from the BOSS-N1 module bay.

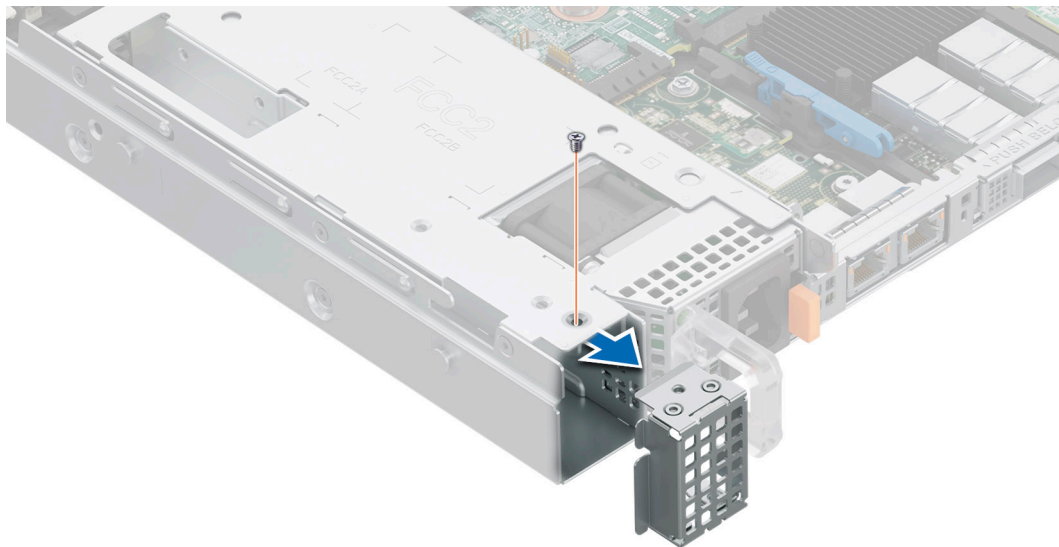

Figure 144. Removing the BOSS-N1 module blank

To install the BOSS blank:

1. Align the blank with the BOSS-N1 module bay and push it into the bay until it clicks into place.

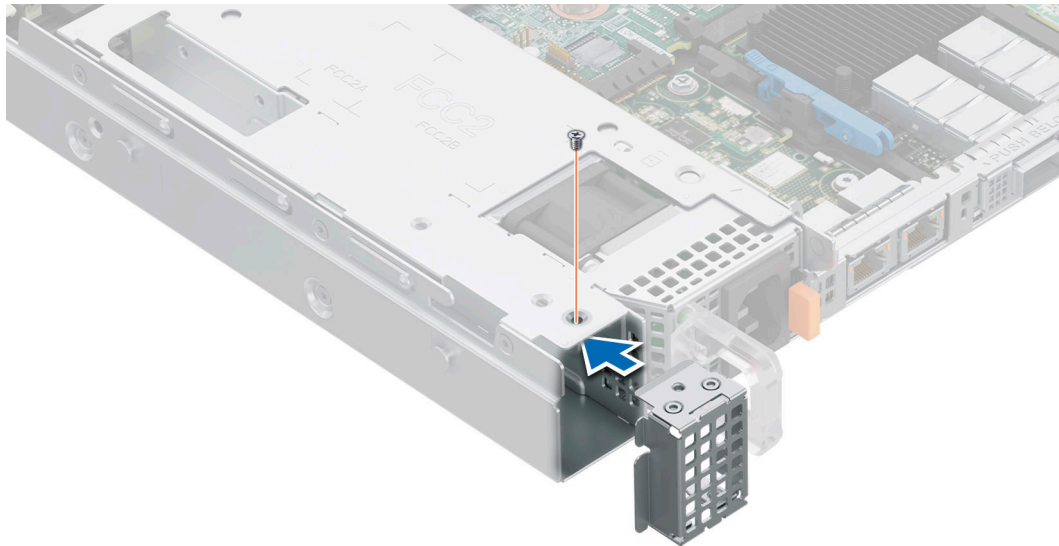

Figure 145. Installing the BOSS-N1 module blank

To install the BOSS-N1 module:

1. Install the BOSS-N1 module . To install the BOSS-N1 , see [installing the BOSS-N1 module](#).
2. Install the M.2 SSD. To install the M.2 SSD, see [installing M.2 SSD](#).

NOTE: Installing the BOSS-N1 card carrier does not require the system to be powered off. System shutdown is only required when installing the BOSS-N1 controller card module.

To remove the BOSS-N1 module:

1. Power off the system.
2. Remove the M.2 SSD. To remove the M.2 SSD, see [removing the M.2 SSD](#).
3. Remove the BOSS-N1 module. To remove the BOSS-N1 controller card module, see [removing the BOSS-N1 module](#).
4. Install the BOSS-N1 module blank.

NOTE: Removal of the BOSS-N1 card carrier does not require the system to be powered off. System shutdown is only required when removing the BOSS-N1 module.

NOTE: Disconnect the BOSS signal cable and the BOSS power cable before lifting the module from the system.

Data Processing Unit (DPU) kit

The channel or vendor DPU kit contains one 25G Network card. For installation procedure of Network card, see [Installing an expansion card into the expansion card riser](#) section.

For more information about the supported channel DPU slots, See [Expansion card installation Guidelines](#) section.

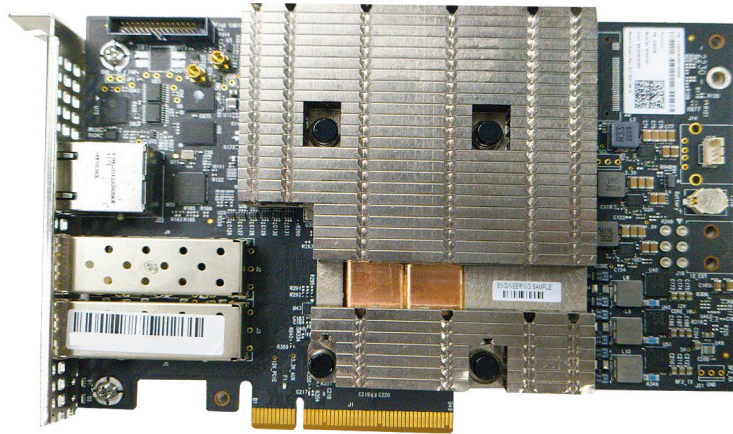

Figure 146. Front View of the DPU card

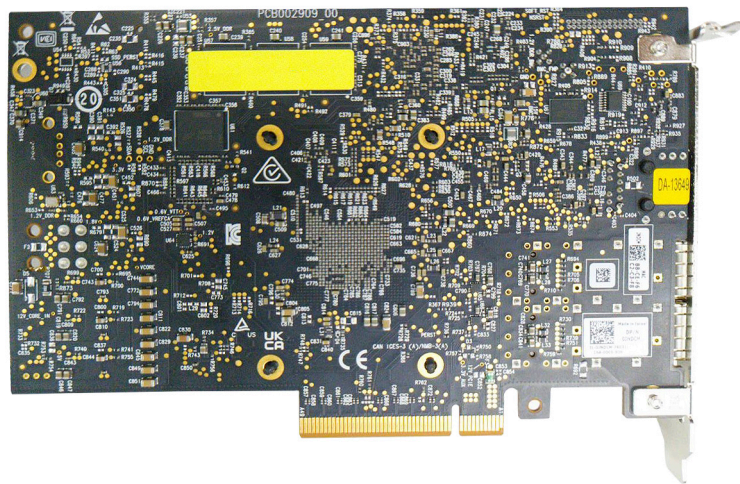

Figure 147. Rear view of the DPU card

i **NOTE:** Mellanox Bluefield2 25Gbe card supports only Nvidia Channel FW and Channel Driver, and does not support Dell FW/Driver SWB DUP updates.

Serial COM port kit

The serial COM port kit contains the components that are listed in the table.

Table 93. Serial COM port kit

| Components | Quantity |
|----------------------|----------|
| Serial COM port card | 1 |
| Cable | 1 |

For installation procedure of the serial COM port, see [serial COM port section](#).

VGA port kit

The VGA port kit contains the components listed in the table.

Table 94. VGA port kit

| Components | Quantity |
|---------------|----------|
| VGA port card | 1 |
| Cable | 1 |

For installation procedure of the VGA port, see [VGA port section](#).

Internal USB card kit

The internal USB card kit contains one internal USB card. For installation of internal USB card, see [internal USB card](#) section.

Jumpers and connectors

This section provides essential and specific information about jumpers and switches. It also describes the connectors on the various boards in the system. Jumpers on the system board help to disable the system and reset the passwords. To install components and cables correctly, you must be able to identify the connectors on the system board.

Topics:

- [System board Connectors](#)
- [System board jumper settings](#)
- [Disabling a forgotten password](#)

System board Connectors

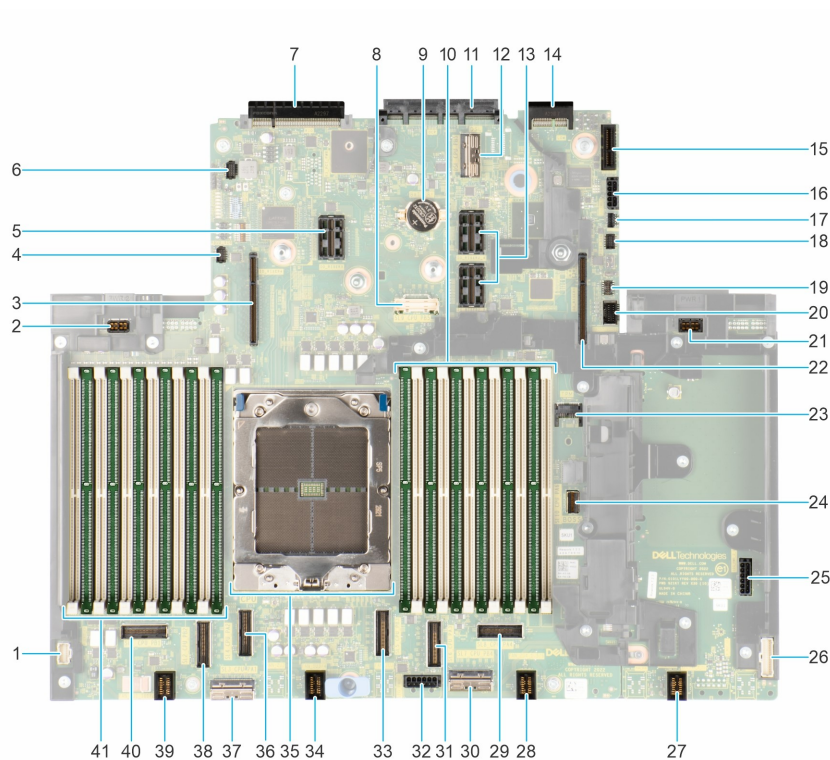

Figure 148. System board jumpers and connectors

Table 95. System board jumpers and connectors

| Item | Connector | Description |
|------|----------------------------|------------------------------|
| 1. | LFT_CP | Left control panel connector |
| 2. | PWR 2_A | Power Connector for PSU2 |
| 3. | Riser 4 | Riser 4 |
| 4. | PSU 2 PUCK sideband signal | PSU 2 PUCK sideband signal |
| 5. | Riser 3 | Riser 3 |





Table 95. System board jumpers and connectors (continued)

| Item | Connector | Description |
|-------------|------------------------------------|---|
| 6. | Battery SIG connector | Battery SIG connector |
| 7. | Rear I/O connector | Rear I/O connector |
| 8. | (SL9_CPU_PB5) | PCIe connector 9 |
| 9. | Coin Cell battery | Coin Cell battery |
| 10. | A1, A5, A3, A9, A7, and A11 | DIMMs for CPU for Channels A, B, C, D, E, and F |
| 11. | OCP NIC 3.0 connector | OCP NIC 3.0 connector |
| 12. | (SL11_CPU1_PB6) | PCIe connector 11 |
| 13. | Riser 2 | Riser 2 |
| 14. | LOM Connector | LOM Connector |
| 15. | Internal USB Connector | Internal USB Connector |
| 16. | PWR Connector 0 | Power Connector 0 |
| 17. | BOSS Card Power | BOSS Card Power |
| 18. | PSU 1 PUCK sideband signal | PSU 1 PUCK sideband signal |
| 19. | Jumper | Jumper |
| 20. | Front VGA connector | Front VGA connector |
| 21. | PWR 1_A | Power Connector for PSU1 |
| 22. | Riser 1 | Riser 1 |
| 23. | TPM connector | TPM connector |
| 24. | (SL10_CPU_PA5) | PCIe connector 10 |
| 25. | PWR connector 2 - use for BP only | Power connector 2 - use for BP only |
| 26. | RGT_CP | Right control panel connector |
| 27. | Fan 4 | Fan 4 |
| 28. | Fan 3 | Fan 3 |
| 29. | (SL8_CPU_PA4) | PCIe connector 8 |
| 30. | (SL7_CPU_PB4) | PCIe connector 7 |
| 31. | (SL6_CPU_PA3) | PCIe connector 6 |
| 32. | PCIe connector 1 - use for BP only | PCIe connector 1 - use for BP only |
| 33. | (SL5_CPU_PB3) | PCIe connector 5 |
| 34. | Fan 2 | Fan 2 |
| 35. | CPU | CPU |
| 36. | (SL4_CPU_PA1) | PCIe connector 4) |
| 37. | (SL3_CPU_PA2) | PCIe connector 3 |
| 38. | (SL2_CPU_PB2) | PCIe connector 2 |
| 39. | Riser 4 | Riser 4 |
| 40. | (SL1_CPU_PB1) | PCIe connector 1 |
| 41. | A2, A6, A4, A10, A8, and A12 | DIMMs for CPU for Channels G, H, I, J, K, and L |

System board jumper settings

For information about resetting the password jumper to disable a password, see the [Disabling a forgotten password](#) section.

Table 96. System board jumper settings

| Jumper | Setting | Description |
|-----------|---|---|
| PWRD_EN |  2 4 6 (default) | The BIOS password feature is enabled. |
| |  2 4 6 | The BIOS password feature is disabled. The BIOS password is now disabled and you are not allowed to set a new password. |
| NVRAM_CLR |  1 3 5 (default) | The BIOS configuration settings are retained at system boot. |
| |  1 3 5 | The BIOS configuration settings are cleared at system boot. |

CAUTION: Be careful when changing the BIOS settings. The BIOS interface is designed for advanced users. Any change in the setting could prevent your system from starting correctly and you might have potential loss of data.

Disabling a forgotten password

The software security features of the system include a system password and a setup password. The password jumper enables or disables password features and clears any password(s) currently in use.

Prerequisites

CAUTION: Many repairs may only be done by a certified service technician. You should only perform troubleshooting and simple repairs as authorized in your product documentation, or as directed by the online or telephone service and support team. Damage due to servicing that is not authorized by Dell is not covered by your warranty. Read and follow the safety instructions that are shipped with your product.

Steps

1. Power off the system, and all the attached peripherals, and disconnect the system from the electrical outlet.
2. Remove the system cover.
3. Move the jumper on the system board from pins 2 and 4 to pins 4 and 6.
4. Replace the system cover.
 - NOTE:** The existing passwords are not disabled (erased) until the system boots with the jumper on pins 4 and 6. However, before you assign a new system and/or setup password, you must move the jumper back to pins 2 and 4.
 - NOTE:** If you assign a new system and/or setup password with the jumper on pins 4 and 6, the system disables the new password(s) the next time it boots.
5. Reconnect the system and all the attached peripherals.
6. Power off the system.
7. Remove the system cover.
8. Move the jumper on the system board from pins 4 and 6 to pins 2 and 4.
9. Replace the system cover.
10. Reconnect the system to the electrical outlet and power on the system, and all the attached peripherals.
11. Assign a new system and/or setup password.

System diagnostics and indicator codes

The diagnostic indicators on the system front panel display system status during system startup.

Topics:

- Power button LED
- Status LED indicators
- System health and system ID indicator codes
- iDRAC Quick Sync 2 indicator codes
- iDRAC Direct LED indicator codes
- LCD panel
- NIC indicator codes
- Power supply unit indicator codes
- Drive indicator codes
- Using system diagnostics

Power button LED

The power button LED is located on the front panel of your system.



Figure 149. Power button LED

Table 97. Power button LED

| Power button LED indicator code | Condition |
|---------------------------------|--|
| Off | System is not operating, regardless of power supply available. |
| On | System is operating, one or more of the non-standby power supply units are active. |
| Slowly blinking | System is performing powering on sequence and iDRAC is still booting. |

Status LED indicators

NOTE: The indicators display solid amber if any error occurs.

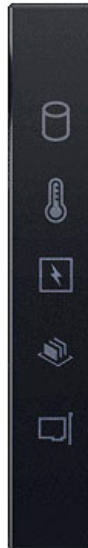

Figure 150. Status LED indicators

Table 98. Status LED indicators and descriptions





| Icon | Description | Condition | Corrective action |
|---|-----------------------|--|--|
|  | Drive indicator | The indicator turns solid amber if there is a drive error. | <ul style="list-style-type: none"> • Check the System Event Log to determine if the drive has an error. • Run the appropriate Online Diagnostics test. Restart the system and run embedded diagnostics (ePSA). • If the drives are configured in a RAID array, restart the system, and enter the host adapter configuration utility program. |
|  | Temperature indicator | The indicator turns solid amber if the system experiences a thermal error (for example, the ambient temperature is out of range or there is a fan failure). | <p>Ensure that none of the following conditions exist:</p> <ul style="list-style-type: none"> • A cooling fan has been removed or has failed. • System cover, air shrouds, or back filler bracket has been removed. • Ambient temperature is too high. • External airflow is obstructed. <p>If the problem persists, see the Getting help section.</p> |
|  | Electrical indicator | The indicator turns solid amber if the system experiences an electrical error (for example, voltage out of range, or a failed power supply unit (PSU) or voltage regulator). | <p>Check the System Event Log or system messages for the specific issue. If it is due to a problem with the PSU, check the LED on the PSU. Reseat the PSU.</p> <p>If the problem persists, see the Getting help section.</p> |
|  | Memory indicator | The indicator turns solid amber if a memory error occurs. | <p>Check the System Event Log or system messages for the location of the failed memory. Reseat the memory module.</p> <p>If the problem persists, see the Getting help section.</p> |
|  | PCIe indicator | The indicator turns solid amber if a PCIe card experiences an error. | Restart the system. Update any required drivers for the PCIe card. Reinstall the card. |

Table 98. Status LED indicators and descriptions (continued)

| Icon | Description | Condition | Corrective action |
|------|-------------|-----------|---|
| | | | <p>If the problem persists, see the Getting help section.</p> <p>NOTE: For more information about the supported PCIe cards, see the Expansion cards and expansion card risers > Expansion card installation guidelines section.</p> |

System health and system ID indicator codes

The system health and system ID indicator is located on the left control panel of the system.



Figure 151. System health and system ID indicator

Table 99. System health and system ID indicator codes

| System health and system ID indicator code | Condition |
|--|--|
| Solid blue | Indicates that the system is powered on, is healthy, and system ID mode is not active. Press the system health and system ID button to switch to system ID mode. |
| Blinking blue | Indicates that the system ID mode is active. Press the system health and system ID button to switch to system health mode. |
| Solid amber | Indicates that the system is in fail-safe mode. If the problem persists, see the Getting help section. |
| Blinking amber | Indicates that the system is experiencing a fault. Check the System Event Log for specific error messages. For |

Table 99. System health and system ID indicator codes (continued)

| System health and system ID indicator code | Condition |
|--|--|
| | information about the event and error messages generated by the system firmware and agents that monitor system components, go to qrl.dell.com > Look Up > Error Code , type the error code, and then click Look it up . |

iDRAC Quick Sync 2 indicator codes

iDRAC Quick Sync 2 module (optional) is located on the left control panel front IO panel of the system.



Table 100. iDRAC Quick Sync 2 indicators and descriptions

| iDRAC Quick Sync 2 indicator code | Condition | Corrective action |
|---|---|---|
| Off (default state) | Indicates that the iDRAC Quick Sync 2 feature is powered off. Press the iDRAC Quick Sync 2 button to power on the iDRAC Quick Sync 2 feature. | If the LED fails to power on, reset the left control panel flex cable and check. If the problem persists, see the Getting help section. |
| Solid white | Indicates that iDRAC Quick Sync 2 is ready to communicate. Press the iDRAC Quick Sync 2 button to power off. | If the LED fails to power off, restart the system. If the problem persists, see the Getting help section. |
| Blinks white rapidly | Indicates data transfer activity. | If the indicator continues to blink indefinitely, see the Getting help section. |
| Blinks white slowly | Indicates that firmware update is in progress. | If the indicator continues to blink indefinitely, see the Getting help section. |
| Blinks white five times rapidly and then powers off | Indicates that the iDRAC Quick Sync 2 feature is disabled. | Check if iDRAC Quick Sync 2 feature is configured to be disabled by iDRAC. If the problem persists, see the Getting help section. www.dell.com/poweredgemanuals or <i>Dell OpenManage Server Administrator User's Guide</i> at https://www.dell.com/openmanagemanuals . |
| Solid amber | Indicates that the system is in fail-safe mode. | Restart the system. If the problem persists, see the Getting help section. |
| Blinking amber | Indicates that the iDRAC Quick Sync 2 hardware is not responding properly. | Restart the system. If the problem persists, see the Getting help section. |

iDRAC Direct LED indicator codes

The iDRAC Direct LED indicator lights up to indicate that the port is connected and is being used as a part of the iDRAC subsystem.

You can configure iDRAC Direct by using a USB to micro USB (type AB) cable, which you can connect to your laptop or tablet. Cable length should not exceed 3 feet (0.91 meters). Performance could be affected by cable quality. The following table describes iDRAC Direct activity when the iDRAC Direct port is active:

Table 101. iDRAC Direct LED indicator codes

| iDRAC Direct LED indicator code | Condition |
|---|--|
| Solid green for two seconds | Indicates that the laptop or tablet is connected. |
| Blinking green (on for two seconds and off for two seconds) | Indicates that the laptop or tablet connected is recognized. |
| LED Indicator off | Indicates that the laptop or tablet is unplugged. |

LCD panel

The LCD panel provides system information, status, and error messages to indicate if the system is functioning correctly or requires attention. The LCD panel is used to configure or view the iDRAC IP address of the system. For information about the event and error messages generated by the system firmware and agents that monitor system components, go to qrl.dell.com > **Look Up > Error Code**, type the error code, and then click **Look it up**.

The LCD panel is available only on the optional front bezel. The optional front bezel is hot pluggable.

The status and conditions of the LCD panel are outlined here:

- The LCD backlight is white during normal operating conditions.
 - If there is an issue, the LCD backlight turns amber and displays an error code followed by descriptive text.
 - ⓘ **NOTE:** If the system is connected to a power source and an error is detected, the LCD turns amber regardless of whether the system is powered on or off.
 - When the system powers off and there are no errors, the LCD enters the standby mode after five minutes of inactivity. Press any button on the LCD to power it on.
 - If the LCD panel stops responding, remove the bezel and reinstall it.
- If the problem persists, see [Getting help](#).
- The LCD backlight remains off if LCD messaging is powered off using the iDRAC utility, the LCD panel, or other tools.

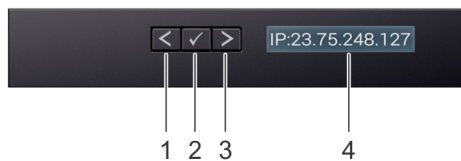

Figure 152. LCD panel features



Table 102. LCD panel features

| Item | Button or display | Description |
|------|-------------------|---|
| 1 | Left | Moves the cursor back in one-step increments. |
| 2 | Select | Selects the menu item highlighted by the cursor. |
| 3 | Right | Moves the cursor forward in one-step increments. During message scrolling: <ul style="list-style-type: none"> • Press and hold the right button to increase scrolling speed. • Release the button to stop. ⓘ NOTE: The display stops scrolling when the button is released. After 45 seconds of inactivity, the display starts scrolling. |
| 4 | LCD display | Displays the system information, status, and error messages or iDRAC IP address. |

Viewing Home screen

The **Home** screen displays user-configurable information about the system. This screen is displayed during normal system operation when there are no status messages or errors. When the system turns off and there are no errors, LCD enters the standby mode after five minutes of inactivity. Press any button on the LCD to turn it on.

Steps

1. To view the **Home** screen, press one of the three navigation buttons (Select, Left, or Right).
2. To navigate to the **Home** screen from another menu, complete the following steps:
 - a. Press and hold the navigation button till the up arrow  is displayed.
 - b. Navigate to the **Home** icon  using the up arrow .
 - c. Select the **Home** icon.
 - d. On the **Home** screen, press the **Select** button to enter the main menu.

Setup menu

 **NOTE:** When you select an option in the Setup menu, you must confirm the option before proceeding to the next action.

Table 103. Setup menu

| Option | Description |
|-----------|---|
| iDRAC | Select DHCP or Static IP to configure the network mode. If Static IP is selected, the available fields are IP , Subnet (Sub) , and Gateway (Gtw) . Select Setup DNS to enable DNS and to view domain addresses. Two separate DNS entries are available. |
| Set error | Select SEL to view LCD error messages in a format that matches the IPMI description in the SEL. This enables you to match an LCD message with an SEL entry. Select Simple to view LCD error messages in a simplified user-friendly description. For information about the event and error messages generated by the system firmware and agents that monitor system components, go to qrl.dell.com > Look Up > Error Code , type the error code, and then click Look it up .. |
| Set home | Select the default information to be displayed on the Home screen. See View Home menu section for the options and option items that can be set as the default on the Home screen. |

View menu

 **NOTE:** When you select an option in the View menu, you must confirm the option before proceeding to the next action.

Table 104. View menu

| Option | Description |
|-------------|--|
| iDRAC IP | Displays the IPv4 or IPv6 addresses for iDRAC9. Addresses include DNS (Primary and Secondary) , Gateway, IP , and Subnet (IPv6 does not have Subnet). |
| MAC | Displays the MAC addresses for iDRAC , iSCSI , or Network devices. |
| Name | Displays the name of the Host , Model , or User String for the system. |
| Number | Displays the Asset tag or the Service tag for the system. |
| Power | Displays the power output of the system in BTU/hr or Watts. The display format can be configured in the Set home submenu of the Setup menu. |
| Temperature | Displays the temperature of the system in Celsius or Fahrenheit. The display format can be configured in the Set home submenu of the Setup menu. |

NIC indicator codes

Each NIC on the back of the system has indicators that provide information about the activity and link status. The activity LED indicator indicates if data is flowing through the NIC, and the link LED indicator indicates the speed of the connected network.

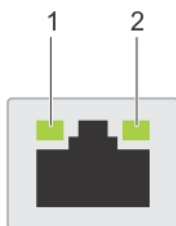

Figure 153. NIC indicator codes

1. Link LED indicator
2. Activity LED indicator

Table 105. NIC indicator codes

| NIC indicator codes | Condition |
|--|---|
| Link and activity indicators are off. | Indicates that the NIC is not connected to the network. |
| Link indicator is green, and activity indicator is blinking green. | Indicates that the NIC is connected to a valid network at its maximum port speed, and data is being sent or received. |
| Link indicator is amber, and activity indicator is blinking green. | Indicates that the NIC is connected to a valid network at less than its maximum port speed, and data is being sent or received. |
| Link indicator is green, and activity indicator is off. | Indicates that the NIC is connected to a valid network at its maximum port speed, and data is not being sent or received. |
| Link indicator is amber, and activity indicator is off. | Indicates that the NIC is connected to a valid network at less than its maximum port speed, and data is not being sent or received. |
| Link indicator is blinking green, and activity is off. | Indicates that the NIC identity is enabled through the NIC configuration utility. |

Power supply unit indicator codes

AC and DC power supply units (PSUs) have an illuminated translucent handle that serves as an indicator. The indicator shows if power is present or if a power fault has occurred.

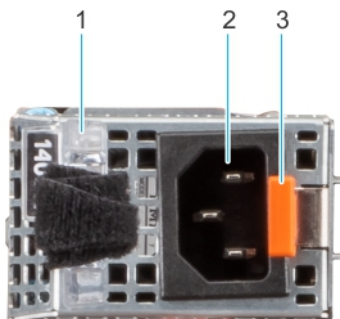

Figure 154. AC PSU status indicator

1. AC PSU handle
2. Socket
3. Release latch

Table 106. AC and DC PSU status indicator codes

| Power indicator codes | Condition |
|-------------------------------|--|
| Green | Indicates that a valid power source is connected to the PSU and the PSU is operational. |
| Blinking amber | Indicates an issue with the PSU. |
| Not powered on | Indicates that the power is not connected to the PSU. |
| Blinking green | <p>Indicates that the firmware of the PSU is being updated.</p> <p>⚠ CAUTION: Do not disconnect the power cord or unplug the PSU when updating firmware. If firmware update is interrupted, the PSUs will not function.</p> |
| Blinking green and powers off | <p>When hot-plugging a PSU, it blinks green five times at a rate of 4 Hz and powers off. This indicates a PSU mismatch due to efficiency, feature set, health status, or supported voltage.</p> <p>⚠ CAUTION: If two PSUs are installed, both the PSUs must have the same type of label; for example, Extended Power Performance (EPP) label. Mixing PSUs from previous generations of PowerEdge servers is not supported, even if the PSUs have the same power rating. This results in a PSU mismatch condition or failure to power on the system.</p> <p>⚠ CAUTION: If two PSUs are used, they must be of the same type and have the same maximum output power.</p> <p>⚠ CAUTION: When correcting a PSU mismatch, replace the PSU with the blinking indicator. Swapping the PSU to make a matched pair can result in an error condition and an unexpected system shutdown. To change from a high output configuration to a low output configuration or vice versa, you must power off the system.</p> <p>⚠ CAUTION: AC PSUs support both 240 V and 120 V input voltages with the exception of Titanium PSUs, which support only 240 V. When two identical PSUs receive different input voltages, they can output different wattages, and trigger a mismatch.</p> |

Drive indicator codes

The LEDs on the drive carrier indicate the state of each drive. Each drive carrier has two LEDs: an activity LED (green) and a status LED (bicolor, green/amber). The activity LED blinks whenever the drive is accessed.

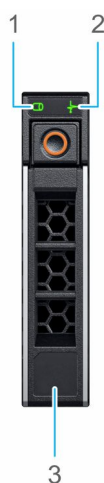

Figure 155. Drive indicators

1. Drive activity LED indicator
2. Drive status LED indicator
3. Drive capacity label

NOTE: If the drive is in the Advanced Host Controller Interface (AHCI) mode, the status LED indicator does not power on.

NOTE: Drive status indicator behavior is managed by Storage Spaces Direct. Not all drive status indicators may be used.

Table 107. Drive indicator codes

| Drive status indicator code | Condition |
|--|---|
| Blinks green twice per second | Indicates that the drive is being identified or preparing for removal. |
| Not powered on | Indicates that the drive is ready for removal. NOTE: The drive status indicator remains off until all drives are initialized after the system is powered on. Drives are not ready for removal during this time. |
| Blinks green, amber, and then powers off | Indicates that there is an unexpected drive failure. |
| Blinks amber four times per second | Indicates that the drive has failed. |
| Blinks green slowly | Indicates that the drive is rebuilding. |
| Solid green | Indicates that the drive is online. |
| Blinks green for three seconds, amber for three seconds, and then powers off after six seconds | Indicates that the rebuild has stopped. |

Using system diagnostics

If you experience an issue with the system, run the system diagnostics before contacting Dell for technical assistance. The purpose of running system diagnostics is to test the system hardware without using additional equipment or risking data loss. If you are unable to fix the issue yourself, service and support personnel can use the diagnostics results to help you solve the issue.

Dell Embedded System Diagnostics

NOTE: The Dell Embedded System Diagnostics is also known as Enhanced Pre-boot System Assessment (ePSA) diagnostics.

The Embedded System Diagnostics provide a set of options for particular device groups or devices allowing you to:

- Run tests automatically or in an interactive mode
- Repeat tests
- Display or save test results
- Run thorough tests to introduce additional test options to provide extra information about the failed device(s)
- View status messages that inform you if tests are completed successfully
- View error messages that inform you of issues encountered during testing

Running the Embedded System Diagnostics from Boot Manager

Run the Embedded System Diagnostics (ePSA) if your system does not boot.

Steps

1. When the system is booting, press F11.
2. Use the up arrow and down arrow keys to select **System Utilities > Launch Diagnostics**.
3. Alternatively, when the system is booting, press F10, select **Hardware Diagnostics > Run Hardware Diagnostics**.
The **ePSA Pre-boot System Assessment** window is displayed, listing all devices detected in the system. The diagnostics starts executing the tests on all the detected devices.

Running the Embedded System Diagnostics from the Dell Lifecycle Controller

Steps

1. When the system is booting, press F10.
2. Select **Hardware Diagnostics → Run Hardware Diagnostics**.
The **ePSA Pre-boot System Assessment** window is displayed, listing all devices detected in the system. The diagnostics start executing the tests on all the detected devices.

System diagnostic controls

Table 108. System diagnostic controls

| Menu | Description |
|----------------------|---|
| Configuration | Displays the configuration and status information of all detected devices. |
| Results | Displays the results of all tests that are run. |
| System health | Provides the current overview of the system performance. |
| Event log | Displays a time-stamped log of the results of all tests run on the system. This is displayed if at least one event description is recorded. |

Getting help

You can download drivers, firmware and documents from the FTP site: <https://mft.dell.com/R6615>. For more information about username and password, contact your TAM (Tech Account Manager).

The QRL, SupportAssist/ Secure Connect Gateway, and eSupport sites will be launched in Quarter 4 of the calendar year 2022.

Topics:

- [Recycling or End-of-Life service information](#)
- [Contacting Dell Technologies](#)
- [Accessing system information by using QRL](#)

Recycling or End-of-Life service information

Take back and recycling services are offered for this product in certain countries. If you want to dispose of system components, visit www.dell.com/recyclingworldwide and select the relevant country.

Contacting Dell Technologies

Dell provides online and telephone based support and service options. If you do not have an active internet connection, you can find Dell contact information on your purchase invoice, packing slip, bill or Dell product catalog. The availability of services varies depending on the country and product, and some services may not be available in your area. To contact Dell for sales, technical assistance, or customer service issues follow these steps:

Steps

1. Go to www.dell.com/support/home.
2. Select your country from the drop-down menu on the lower right corner of the page.
3. For customized support:
 - a. Enter the system Service Tag in the **Enter a Service Tag, Serial Number, Service Request, Model, or Keyword** field.
 - b. Click **Search**.
The support page that lists the various support categories is displayed.
4. For general support:
 - a. Select your product category.
 - b. Select your product segment.
 - c. Select your product.
The support page that lists the various support categories is displayed.
5. For contact details of Dell Global Technical Support:
 - a. Click [Contact Technical Support](#).
 - b. The **Contact Technical Support** page is displayed with details to call, chat, or e-mail the Dell Global Technical Support team.

Accessing system information by using QRL

You can use the Quick Resource Locator (QRL) located on the information tag in the front of the system, to access information about PowerEdge R6615. There is also another QRL for accessing product information located on the back of the system cover.

Prerequisites

Ensure that your smartphone or tablet has a QR code scanner installed.

The QRL includes the following information about your system:

- How-to videos
- Reference materials, including the Installation and Service Manual, and mechanical overview
- The system service tag to quickly access the specific hardware configuration and warranty information
- A direct link to Dell to contact technical assistance and sales teams

Steps

1. Go to www.dell.com/qrl, and navigate to your specific product or
2. Use your smart phone or tablet to scan the model-specific Quick Resource (QR) code on your system or in the Quick Resource Locator section.



Figure 156. Quick Resource Locator for PowerEdge R6615 system

Receiving automated support with SupportAssist

Dell SupportAssist is an optional Dell Services offering that automates technical support for your Dell server, storage, and networking devices. By installing and setting up a SupportAssist application in your IT environment, you can receive the following benefits:

- Automated issue detection — SupportAssist monitors your Dell devices and automatically detects hardware issues, both proactively and predictively.
- Automated case creation — When an issue is detected, SupportAssist automatically opens a support case with Dell Technical Support.
- Automated diagnostic collection — SupportAssist automatically collects system state information from your devices and uploads it securely to Dell. This information is used by Dell Technical Support to troubleshoot the issue.
- Proactive contact — A Dell Technical Support agent contacts you about the support case and helps you resolve the issue.

The available benefits vary depending on the Dell Service entitlement purchased for your device. For more information about SupportAssist, go to www.dell.com/supportassist.

Documentation resources

This section provides information about the documentation resources for your system.

To view the document that is listed in the documentation resources table:

- From the Dell support site:
 1. Click the documentation link that is provided in the Location column in the table.
 2. Click the required product or product version.
-  **NOTE:** To locate the model number, see the front of your system.
- 3. On the Product Support page, click **Documentation**.
- Using search engines:
 - Type the name and version of the document in the search box.

Table 109. Additional documentation resources for your system

| Task | Document | Location |
|-------------------------|--|--|
| Setting up your system | <p>For more information about installing and securing the system into a rack, see the Rail Installation Guide included with your rail solution.</p> <p>For information about setting up your system, see the <i>Getting Started Guide</i> document that is shipped with your system.</p> | www.dell.com/poweredgemanuals |
| Configuring your system | <p>For information about the iDRAC features, configuring and logging in to iDRAC, and managing your system remotely, see the Integrated Dell Remote Access Controller User's Guide.</p> <p>For information about understanding Remote Access Controller Admin (RACADM) subcommands and supported RACADM interfaces, see the RACADM CLI Guide for iDRAC.</p> <p>For information about Redfish and its protocol, supported schema, and Redfish Eventing implemented in iDRAC, see the Redfish API Guide.</p> <p>For information about iDRAC property database group and object descriptions, see the Attribute Registry Guide.</p> <p>For information about Intel QuickAssist Technology, see the Integrated Dell Remote Access Controller User's Guide.</p> | www.dell.com/poweredgemanuals |
| | <p>For information about earlier versions of the iDRAC documents.</p> <p>To identify the version of iDRAC available on your system, on the iDRAC web interface, click ? > About.</p> | www.dell.com/idracmanuals |

Table 109. Additional documentation resources for your system (continued)

| Task | Document | Location |
|--|--|--|
| | For information about installing the operating system, see the operating system documentation. | www.dell.com/operatingsystemmanuals |
| | For information about updating drivers and firmware, see the Methods to download firmware and drivers section in this document. | www.dell.com/support/drivers |
| Managing your system | For information about systems management software offered by Dell, see the Dell OpenManage Systems Management Overview Guide. | www.dell.com/poweredgemanuals |
| | For information about setting up, using, and troubleshooting OpenManage, see the Dell OpenManage Server Administrator User's Guide. | www.dell.com/openmanagemanuals > OpenManage Server Administrator |
| | For information about installing and using Dell SupportAssist, see the Dell SupportAssist Enterprise User's Guide. | https://www.dell.com/serviceabilitytools |
| | For information about partner programs enterprise systems management, see the OpenManage Connections Enterprise Systems Management documents. | www.dell.com/openmanagemanuals |
| Working with the Dell PowerEdge RAID controllers | For information about understanding the features of the Dell PowerEdge RAID controllers (PERC), Software RAID controllers, or BOSS card and deploying the cards, see the Storage controller documentation. | www.dell.com/storagecontrollermanuals |
| Understanding event and error messages | For information about the event and error messages generated by the system firmware and agents that monitor system components, go to qrl.dell.com > Look Up > Error Code , type the error code, and then click Look it up . | www.dell.com/qrl |
| Troubleshooting your system | For information about identifying and troubleshooting the PowerEdge server issues, see the Server Troubleshooting Guide. | www.dell.com/poweredgemanuals |