



Savi 7310/7320 Office

Wireless DECT headset system for
computer and desk phone

User Guide

Contents

DECT Information	3
DECT Enhanced Security	3
Overview	4
Headset overview	4
Base overview	5
Accessories	5
Hook up system	7
Desk phone setup details	7
Subscribe headset to base	10
Automatic secure subscription	10
Manual over-the-air subscription	10
Ending subscription	10
Fit and charge	11
Wear on the right or left	11
Charge your headset	11
Talk Time	11
Battery	11
Load software	12
Update firmware	12
System basics	13
Headset overview	13
Power on your headset	13
Adjust volume	13
Make, answer, end calls	13
Interact with Microsoft Teams	15
View Microsoft Teams notifications	15
Stream media	15
More Features	16
Change your default line	16
Optimize audio quality	16
Limit office noise	16
Online indicator	16
Out of Range Warning Tones	16
Troubleshooting	17
Headset	17
Desk phone	18
Softphone	18
What's in the box	20
Support	21

DECT Information

DECT products should never be used outside the region in which they were originally purchased and intended to be used.

The enclosed DECT 6.0 wireless product uses restricted wireless radio frequencies which vary by country. DECT 6.0 devices are generally authorized for use in the US/Canada/Mexico. Use of this DECT 6.0 product in unauthorized countries is a violation of law, may disrupt telecommunications networks and devices, and can subject you to fines and penalties by regulatory agencies.

DECT Enhanced Security

Poly is a member of the DECT Forum and has fully adopted their recommendations for enhancements to security within all DECT products.

Poly DECT-based products now fully incorporate the latest recommendations on Enhanced Security from the DECT Forum and ETSI. These improvements cover registration, authentication, authorization and encryption procedures. Poly DECT products are now secure against known vulnerabilities that were highlighted by the public announcements of the Chaos Communication Congress in 2009.

Poly DECT products have been tested against and passed the DECT Forum security certification requirements and consequently have been granted 'DECT Forum security' logo certification.

Poly DECT products using the new enhanced version of DECT that includes these security improvements are marked on the base with the DECT Forum security logo.



Overview

Headset overview

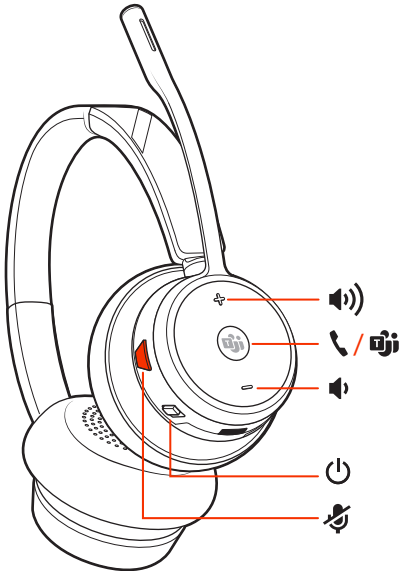

NOTE Headset design may vary but function is the same.

	Volume up
	Call / Press to interact with Microsoft Teams (Teams model only, app required)
	Volume down
	Power
	Mute/unmute

Be safe

Please read the safety guide for important safety, charging, battery and regulatory information before using your new device.

Base overview

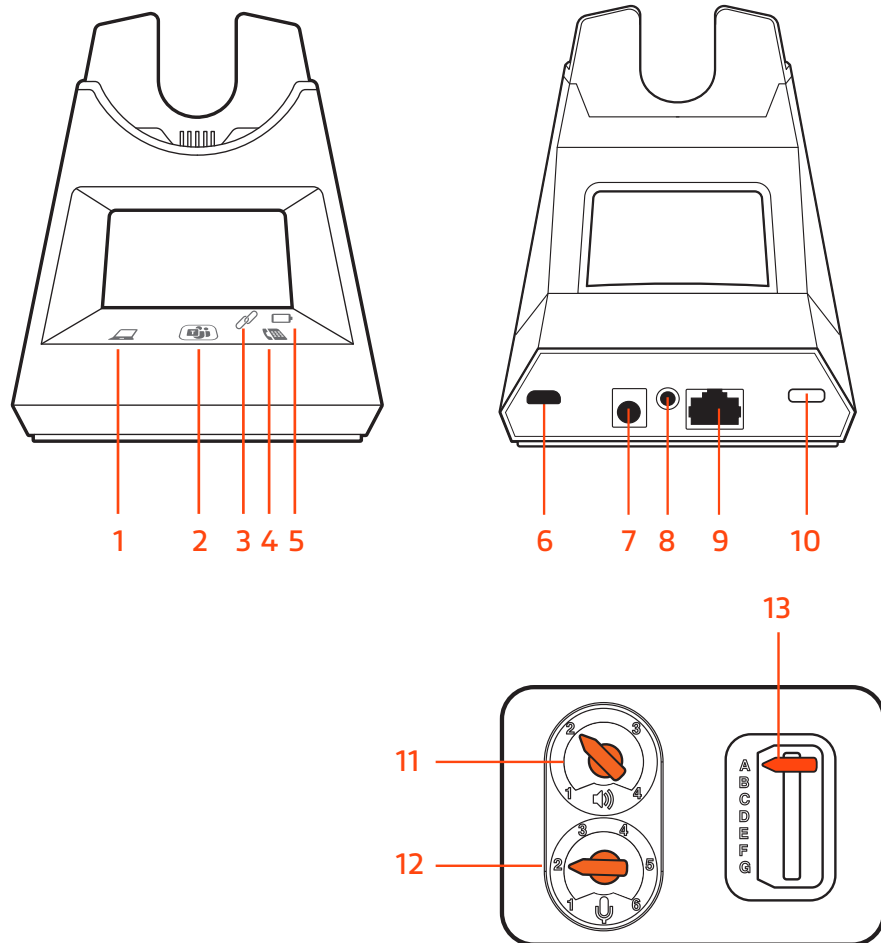

- 1 Computer button
- 2 Microsoft Teams button (Teams model only, app required)
- 3 Subscribe LED
- 4 Desk phone button
- 5 Charging LED
- 6 USB port
- 7 Power jack
- 8 Handset lifter jack
- 9 Telephone interface cable jack
- 10 Headset subscription button
- 11 Desk phone listening volume
- 12 Desk phone speaking volume
- 13 Desk phone configuration switch

Accessories

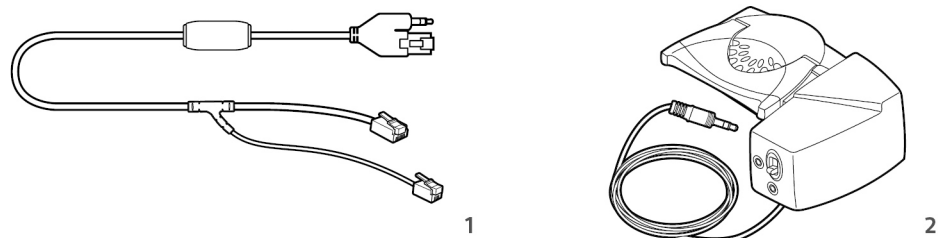

- 1 Electronic hookswitch cable (EHS cable)** Electronically and automatically answers/ends a desk phone call. Enables remote call control with your headset.
- 2 HL10 lifter** Automatically lifts handset and returns it to the cradle. Enables remote call control with your headset.

Hook up system

Using the diagram, connect your headset system.

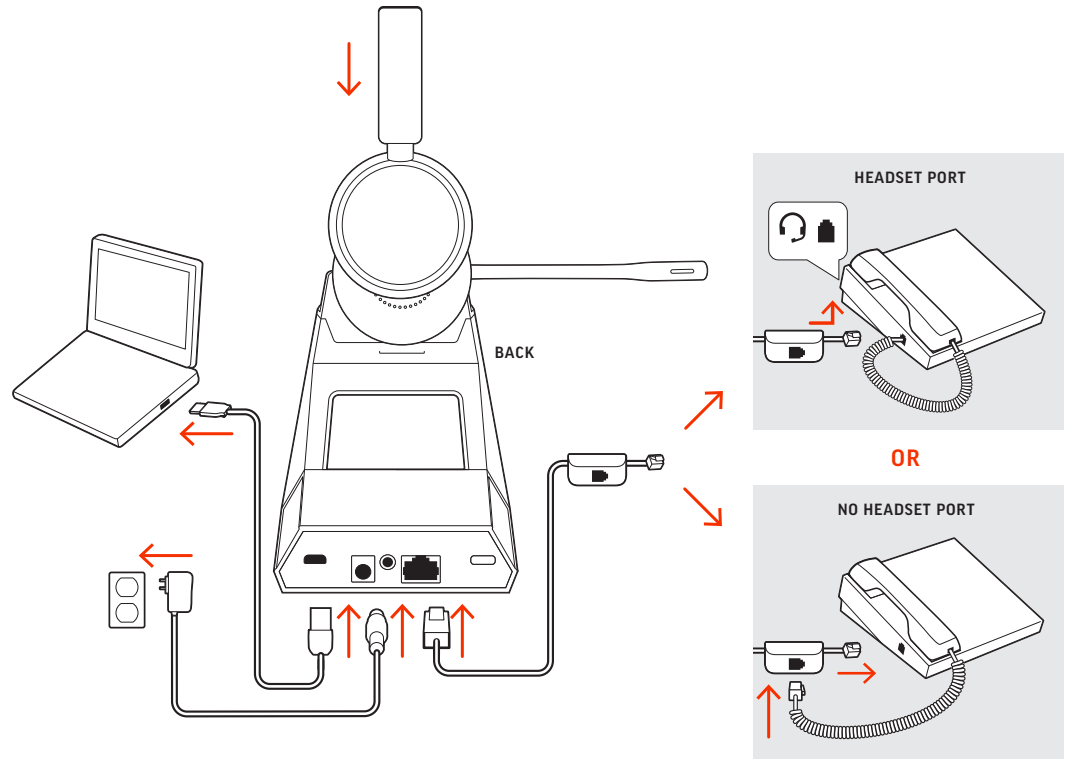

NOTE Base configuration settings

Desk phone	Setting (on bottom of base)
Most phones	A
Cisco phones	D
Cisco phones with EHS cable	A

Desk phone setup details

Choose a desk phone setup **A, B, C or D** and connect cables.

A Desk phone with dedicated headset port

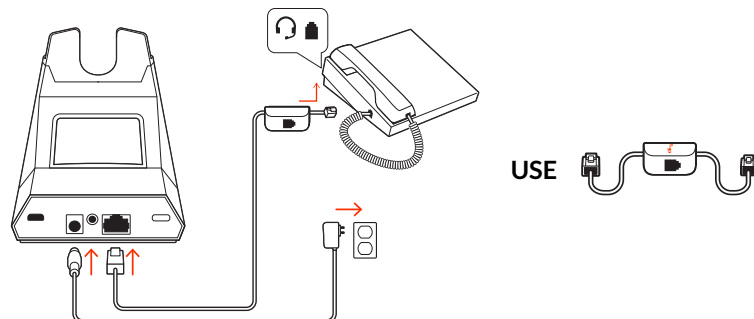

- Connect one end of the telephone interface cable to the back of the base

- Connect the other end of the telephone interface cable into the dedicated headset port on the desk phone

IMPORTANT Cisco phones use configuration D on the bottom of the base. Most other phones use default configuration A.

NOTE Use this setup if you are not using the HL10 lifter or EHS cable. In this configuration, press both the headset button on your desk phone and the call control button on the headset to answer or end calls.

B Desk phone (standard)

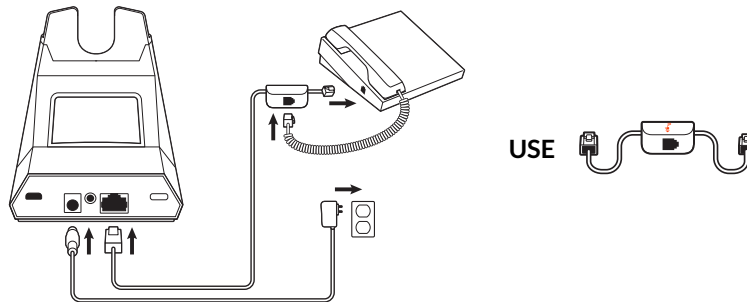

- Connect one end of the telephone interface cable to the back of the base
- Disconnect the handset coil cord from the base of the desk phone and re-connect it to the telephone interface cable junction box
- Finally connect the remaining end of the telephone interface cable into the open handset port on the desk phone

IMPORTANT Cisco phones use configuration D on the bottom of the base. Most other phones use default configuration A.

NOTE Use this setup if you are not using the HL10 lifter or EHS cable and your desk phone does not have a dedicated headset port. In this configuration, manually remove the handset on your desk phone and press the call control button on the headset to answer or end calls.

C Desk phone + EHS cable (sold separately)

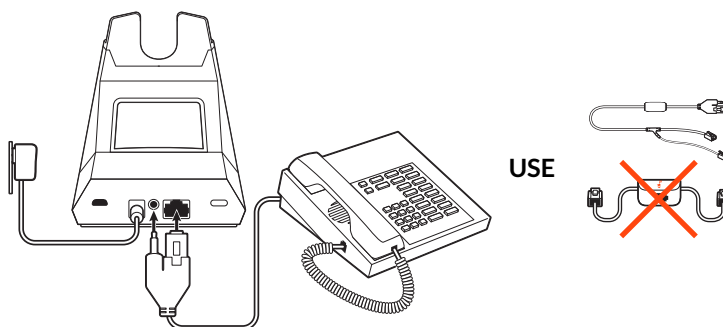

IMPORTANT Use configuration A on the bottom of the base, which works for most phones including Cisco phones.

D Desk phone + HL10 lifter (sold separately)

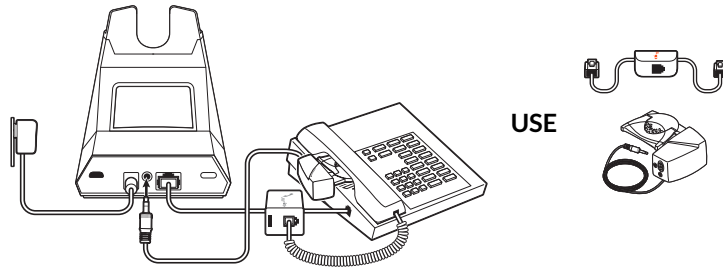

IMPORTANT Cisco phones use configuration **D** on the bottom of the base. Most other phones use default configuration **A**.

Subscribe headset to base

The headset and base that came in the box are subscribed (connected) to each other. However, if you wish to use a new headset or need to restore subscription to your current headset, the units can be subscribed to each other by the following two methods.

Automatic secure subscription

With your system idle, docking a headset will automatically subscribe it to the base, making it the primary headset. The base subscription LED will flash during subscription process and becomes solid green when the new subscription is established.

Manual over-the-air subscription

- 1 With your system idle and your headset undocked, double-click the Subscription button on the back of the base. The subscription LED on the display panel flashes red and green.
- 2 Press and hold the Volume up button on the headset for 4 seconds until the headset LED flashes red and green.
- 3 When the base subscription LED turns solid green and headset LED turns off, the headset and base are subscribed to one another.

NOTE *If the subscription process times out after 2 minutes or if the subscription process fails, try to re-subscribe the headset again.*

Ending subscription

If the base is in subscription mode and you want to stop the base from searching for a headset, press the subscription button again or place the headset in the charge cradle. The subscription LED on the base stops flashing and is solid green.

Fit and charge

Wear on the right or left

To position the microphone on the right or left side, rotate the microphone boom up and over. Gently bend the boom so it is approximately 2 finger widths from the corner of your mouth.

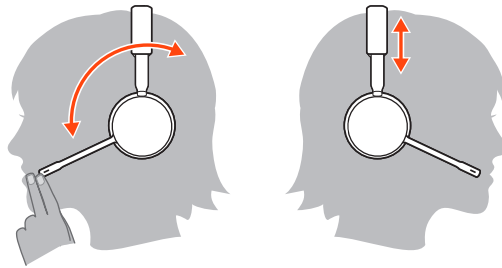

Charge your headset

Place the headset in the charge cradle. The charging LED flashes when charging the headset and remains steady when the headset is fully charged. Charge for at least 20 minutes prior to the first use.

Talk Time

With a full charge, the headset provides up to 13 hours of talk time.

Battery

This product has a replaceable battery. To ensure replacement batteries meet high quality standards and for optimal performance, only use replacement batteries provided by Poly.

Load software

Customize your device behavior through advanced settings and options with Poly Lens App. Some softphones require the installation of Poly software to enable device call control (answer/end and mute) functionality. Download: poly.com/lens.

NOTE *Device settings and updates are also available in Plantronics Hub App.*

Update firmware

Keep your firmware up-to-date to improve performance and add new features to your Poly device.

Update your firmware using your computer with Poly Lens App. Download at poly.com/lens.

While updating firmware:

- Do not use your Poly device until the update is complete.
- Disconnect your Poly device from paired devices such as phones, tablets and computers.
- Do not start a second update from a second device.
- Do not stream media.
- Do not answer or place a call.

System basics

Headset overview

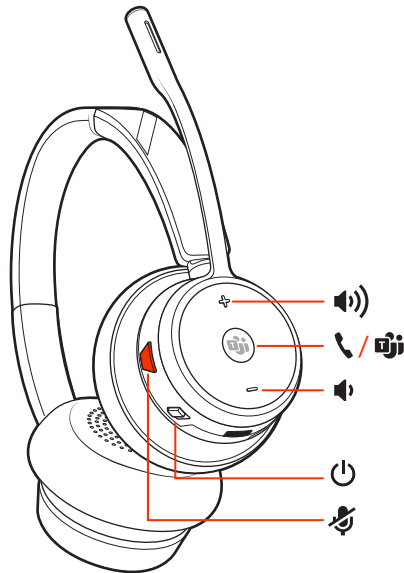

NOTE Headset design may vary but function is the same.

	Volume up
	Call / Press to interact with Microsoft Teams (Teams model only, app required)
	Volume down
	Power
	Mute/unmute

Power on your headset

To turn on the headset, slide the Power button.

Adjust volume

- **Headset volume** Fine-tune your headset volume by adjusting the headset's volume up (+) and down (-) controls.
- **Desk phone volume** When you are on a desk phone call and your voice is too quiet/loud, adjust the speaking volume on the bottom of the base. If your caller's voice is too loud/quiet on a desk phone call, adjust the listening volume.
- **Base ringtone volume** Adjust the base ringtone volume setting in Plantronics Hub. This ringtone alerts you if you are not wearing your headset and a call comes in.



Adjust headset microphone volume (softphone)

Place a test softphone call and adjust softphone volume and PC sound volume accordingly.



Make, answer, end calls

On the base there are 2 Audio buttons: computer and desk phone . These buttons allow you to switch to a different audio source.

Make a call

- 1 Tap an Audio button / on the display panel. You hear a dial tone.
Desk phone only: Press phone's Headset  button or manually remove handset if you don't have HL10 lifter or EHS cable.
- 2 Dial from your softphone or desk phone.

End/take a call

To answer or end a call, tap the corresponding Audio button / or tap the headset call button.

Desk phone only: If you don't have an HL10 lifter or EHS cable, press your phone's Headset  button or remove the handset when answering a call and hang up when ending a call.

TIP Headset call control for the computer requires Plantronics software and softphone compatibility. See "Download software."

Mute

During an active call, tap the Mute  button to mute or unmute your headset.

Hold a call



To hold an active call, press the headset Call button for 2 seconds. Press the Call button to resume a held call.

Switch between calls (flash)

To switch between calls, press the headset Call button for 2 seconds.

Mini conference call

Combine audio from your desk phone and computer into a mini conference call.

With one active call and one held call, simultaneously press the base computer  and desk phone  audio buttons for 4 seconds until the LEDs are solid green.

NOTE The audio LEDs are red when your conference call is muted.

Set up a conference call

You can conference up to 3 additional headsets to a call in progress.

Join Savi headsets automatically (same headset type only)

- 1 While on a call, place the guest headset into the primary user's charge cradle. The base subscription LED flashes.
- 2 The primary user hears a triple tone in their headset indicating a conference request. To accept the request, press the primary user's headset Call button within 10 seconds.
- 3 If the process fails or times out because the guest's Call button is not pressed within 10 seconds, the guest subscription is terminated and the guest hears an error tone.

Join Savi headsets manually

- 1 While on a call, press the primary user's base subscription button. The base subscription LED flashes.
- 2 Hold the guest headset's Volume up until the headset LED turns on.
- 3 The primary user hears a triple tone indicating a conference request. To accept the request, press the primary user's headset Call button within 10 seconds.
- 4 If the process fails or times out because the guest's Call button is not pressed within 10 seconds, the guest subscription is terminated and the guest hears an error tone.



NOTE Headsets in a conference have independent mute controls. The base only indicates the primary user's mute state.

Exit a conference call

- 1 Guest headsets can remain as guests through multiple calls. To remove a guest headset, press the guest headset's Call button or dock the primary user's headset in the charge cradle. The primary user hears a single tone in their headset as each guest leaves the call.
NOTE *The primary user may hear additional tones in their headset and see the base subscription LED flash as guest headsets join the call. These indicate that a guest headset has a different firmware version than the primary headset, but can still be used for conferencing.*

Interact with Microsoft Teams

Press the Teams  button to interact with Microsoft Teams when not on a call (model and application required).

NOTE *Your headset's Call  button is also the Microsoft Teams  button.*

View Microsoft Teams notifications

Your base's Microsoft Teams button LED pulses when you have a Teams notification. Tap the button to view notifications on your computer.

Stream media

To stream media from your computer, first press the base's Computer Audio  button and then play the media.

More Features

Change your default line

Change the default outbound phone line/audio channel.

With the system idle, do one of the following:

- On your base, press the desired audio button for 4 seconds until it flashes 4 times.
- Download and open Poly Lens Desktop App on your computer, go to Device Name > Settings > General > Default Phone Line and choose the desired audio line.

Optimize audio quality

There are 3 audio modes: wideband stereo (hybrid), wideband (conversation) and multimedia (music).

To optimize your audio quality for your activity, with the system idle, press the headset Mute button for 4 seconds. The headset cycles through the modes with each 4 second press. Also configurable in Plantronics Hub.

Limit office noise

You can limit the amount of nearby conversation that is transmitted during your calls.

Open Plantronics Hub. Go to Settings > General > Close Conversation Limiting. Changes take effect with the next call. The default is Standard mode which is optimized for most environments.

Online indicator

Your headset LED flashes green to inform others that you are on a call. Your headset LED is solid red when you are muted. Manage settings in Poly Lens Desktop App.

Out of Range Warning Tones

If you are on a call and go out of the operating range, you will hear three low tones. You will hear a single mid tone when you are back in range.

If you stay out of range, active calls will be suspended. Calls will be re-established when you walk back into range. If you remain out of range for more than 5 minutes, the system will drop the call.

If you are not on a call and go out of the operating range and press the call button, you will hear a single tone for the button press and three low tones for the failure to make a link.

Troubleshooting

Headset

I can't hear a dial tone in the headset.

- Make sure your headset is charged.
- Make sure your headset is subscribed to base. See [Subscribe headset to base](#).
- Adjust the configuration switch (A--G) on the bottom of the base until a dial tone is heard. The default **A** works for most phones.
ATTENTION Use configuration **D** for Cisco phones. Cisco phones connected with EHS cable use configuration **A**.
- Make sure your desk phone is connected correctly to your base. See [Desk phone setup details](#).
- If your base is connected to your desk phone's dedicated headset port, press the desk phone's headset button to hear a dial tone.
- If your base is connected to your desk phone's dedicated headset port, press the desk phone's headset button and base's desk phone button to hear a dial tone.
- If your base is connected to your handset port, manually remove the handset to hear a dial tone (if you do not have an EHS cable or HL10 lifter).
- Make sure your HL10 lifter is lifting the handset high enough to operate the hookswitch; set to a higher setting if necessary.
- Adjust the headset's listening volume. See [Adjust volume](#).
- If the volume is still too low, adjust the desk phone listening volume on the base. See [Adjust volume](#).

I hear static.

- Make sure there is at least 12 inches between your base and your computer, and 6 inches between your base and your telephone. If adjusting the distance doesn't help, your headset is going out of range, move closer to the base. See [Position Your Base](#).

The sound is distorted.

- Lower the desk phone speaking volume and/or desk phone listening volume on the base. For most telephones the correct setting is position 2. See [Adjust volume](#).
- If your desk phone has a volume control, lower until the distortion disappears.
- If the distortion is still present, adjust the headset volume control to lower the headset speaker volume. See [Adjust volume](#).
- Make sure there is 12 inches between your base and your computer, and 6 inches between your base and your telephone. See [Position Your Base](#).

I hear echo in the headset.

- Lower the desk phone speaking volume and/or desk phone listening volume on the base. For most telephones the correct setting is position 2. See [Adjust volume](#).

- If the audio level is too low in this position, increase the headset volume. See *Adjust volume*.
- If your speaking volume is too low for your listener in this position, adjust the position of the headset to make sure the microphone is as close as possible to your mouth.

People I talk to can hear a buzz in the background.

- Move the base further away from your phone. See *Position Your Base*.
- If the base power supply is plugged into a power strip, plug it into the wall directly.

The headset feels too tight over my ears.

- Gently flex the headband wider

Desk phone

The handset lifter is installed but does not lift the handset.

- Be sure the handset lifter power cord is firmly pushed into the handset lifter jack on the base.

I can't hear my desk phone dial tone in the headset.

- Adjust the configuration switch (A--F) on the bottom of the base until a dial tone is heard. The default **A** works for most phones.
ATTENTION Use configuration **D** for Cisco phones. Cisco phones connected with EHS cable use configuration **A**.
- Make sure your desk phone is connected correctly to your base. See *Desk phone setup details*.
- If your base is connected to your desk phone's dedicated headset port, press the desk phone's headset button to hear a dial tone.
- If your base is connected to your desk phone's dedicated headset port, press the desk phone's headset button and base's desk phone button to hear a dial tone.
- If your base is connected to your handset port, manually remove the handset to hear a dial tone (if you do not have an EHS cable or HL10 lifter).

Softphone

When I dial from my softphone application, nothing happens.

- Ensure your headset is powered on.
- Press the headset Call button.
- Make sure your headset is charged.
- Fine tune the listening volume.
- Ensure that your headset is the default sound device by going to your Sound Control Panel (Windows) or your Sound System Preferences (Mac).
- Make sure your headset is subscribed to the USB adapter. See *Subscribe USB adapter again*.
- Ensure that Poly Lens App software is installed. To download, visit poly.com/software.
- Ensure that you are using a compatible softphone application. For a list of compatible softphones, visit poly.com/software.

If the Plantronics software is not installed and you do not have a compatible softphone, you must first press the headset Call button and then use the softphone interface to place/answer/end calls.

Restart your computer.

How do I interact with Microsoft Teams on my Teams-certified headset system?

- Tap your headset's Call button to interact.
- Tap your base's Teams button to interact with Microsoft Teams or to view notifications.

NOTE Teams model and app required.

Does my Microsoft Teams-certified headset system work with other softphones?

Yes, while your headset is optimized for Microsoft Teams, it can be configured to use with other supported softphones. Set your target phone by going to Poly Lens Desktop App > Softphones > Software Settings > Target Softphone

When you configure another softphone, the Call button:

- doesn't interact with Teams
- doesn't go to Teams notifications
- will not launch Cortana

Speaking and/or listening volume is too low or too high.

Adjust headset listening volume.

Adjust listening/speaking volumes in the computer's sound control panel/system preferences.

Adjust listening/speaking volumes in the softphone application.

The sound is distorted or I hear an echo in the headset.

Reduce speaking and/or listening volume on the computer using your softphone application.

Point microphone towards your chin.

If the distortion is still present, lower the volume on the headset.

I can no longer hear any audio through my PC Speakers.

Change the default sound device by going to your Sound Control Panel (Windows) or your Sound System Preferences (Mac) and selecting your PC speakers or internal speakers.

No audio connection to PC.

Unplug USB adapter and then reconnect it.

Quit and then re-start your PC or softphone application.

What's in the box

Contents may vary by product.

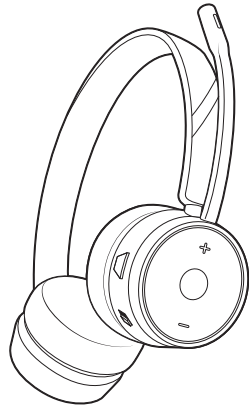

Headset

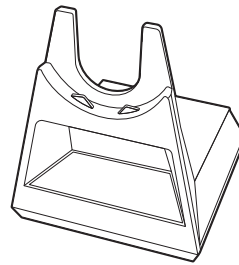

Base

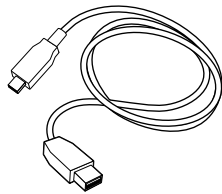

USB cables (3 included):
Micro USB to USB-A, Micro
USB to USB-C, USB-C to
USB-A



Telephone interface cable

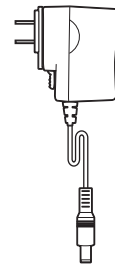

Power supply and plug
adapters

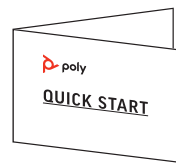

Quick start guide

Support

NEED MORE HELP?

poly.com/support

HP Inc.

1501 Page Mill Road
Palo Alto 94304, U.S.A.
650-857-1501

HP Deutschland GmbH

HP HQ-TRE
71025 Boeblingen, Germany

HP Inc UK Ltd

Regulatory Enquiries, Earley West
300 Thames Valley Park Drive
Reading, RG6 1PT
United Kingdom

© 2023 Poly. DECT is a trademark of ETSI. All trademarks are the property of their respective owners. HP Inc.

Model ID: S7310 CD/S7310-M CD USB-A/USB-C (may be followed by /A, /J or /S), S7320 CD/S7320-M CD USB-A/USB-C (may be followed by /A, /J or /S). System sentence: Savi 7310/7320 Office has a CB7321 CD/-M CD base, (may be followed by /A, /J or /S) and a S7310T/S7320T headset (may be followed by /A, /J or /S).

218230-06 06.23