



FUJITSU Server PRIMERGY TX1320 M5

Upgrade and Maintenance Manual

Comments... Suggestions... Corrections...

The User Documentation Department would like to know your opinion of this manual. Your feedback helps us optimize our documentation to suit your individual needs.

Feel free to send us your comments by e-mail to manuals@ts.fujitsu.com.

Documentation creation according to ISO 9001 and ISO 27001

To ensure high quality and information security standards while creating documentation, the quality management system and information security management system of cognitas are certified in compliance with ISO 9001 and ISO 27001.

cognitas. Gesellschaft für Technik-Dokumentation mbH www.cognitas.de/en/

Copyright and Trademarks

Copyright 2022 FUJITSU LIMITED

All rights reserved.

Delivery subject to availability; right of technical modifications reserved.

All hardware and software names used are trademarks of their respective manufacturers.

- The contents of this manual may be revised without prior notice.
- Fujitsu assumes no liability for damages to third party copyrights or other rights arising from the use of any information in this manual.
- No part of this manual may be reproduced in any form without the prior written permission of Fujitsu.

Microsoft, Windows, Windows Server, and Hyper-V are trademarks or registered trademarks of Microsoft Corporation in the USA and other countries.

Intel and Xeon are trademarks or registered trademarks of Intel Corporation or its subsidiaries in the USA and other countries.

Before reading this manual

For your safety

This manual contains important information for safely and correctly using this product.

Carefully read the manual before using this product. Pay particular attention to the accompanying manual "Safety Notes and Regulations" and ensure that these safety notes are understood before using the product. Keep this manual and the "Safety Notes and Regulations" manual in a safe place for easy reference while using this product.

Radio interference

This product is a "Class A" ITE (Information Technology Equipment). In a domestic environment this product may cause radio interference, in which case the user may be required to take appropriate measures.

VCCI-A

Aluminum electrolytic capacitors

The aluminum electrolytic capacitors used in the printed circuit board assemblies of the product and in the mouse and keyboard are limited-life components. Use of these components beyond their operating life may result in electrolyte leakage or depletion, potentially causing emission of foul odor or smoke.

As a guideline, in a normal office environment (25 °C) operating life is not expected to be reached within the maintenance support period (5 years). However, operating life may be reached more quickly if, for example, the product is used in a hot environment. The customer shall bear the cost of replacing replaceable components which have exceeded their operating life. Note that these are only guidelines, and do not constitute a guarantee of trouble-free operation during the maintenance support period.

High safety use

This product has been designed and manufactured to be used in commercial and/or industrial areas as a server.

The product is not suitable for use at visual display workplaces according to §2 of the Workplace Regulations (applies to all server systems except TX server systems).

When used as visual display workplace, it must not be placed in the direct field of view to avoid incommoding reflections (applies only to TX server systems).

The device has not been designed or manufactured for uses which demand an extremely high level of safety and carry a direct and serious risk of life or body if such safety cannot be assured.

These uses include control of nuclear reactions in nuclear power plants, automatic airplane flight control, air traffic control, traffic control in mass transport systems, medical devices for life support, and missile guidance control in weapons systems (hereafter, "high safety use"). Customers should not use this product for high safety use unless measures are in place for ensuring the level of safety demanded of such use. Please consult the sales staff of Fujitsu if intending to use this product for high safety use.

Measures against momentary voltage drop

This product may be affected by a momentary voltage drop in the power supply caused by lightning. To prevent a momentary voltage drop, the use of an uninterruptible power supply is recommended.

(This notice follows the guidelines of Voltage Dip Immunity of Personal Computer issued by JEITA, the Japan Electronics and Information Technology Industries Association.)

Technology controlled by the Foreign Exchange and Foreign Trade Control Law of Japan

Documents produced by Fujitsu may contain technology controlled by the Foreign Exchange and Foreign Trade Control Law of Japan. Documents which contain such technology should not be exported from Japan or transferred to non-residents of Japan without first obtaining authorization in accordance with the above law.

Harmonic Current Standards

This product conforms to harmonic current standard JIS C 61000-3-2.

Only for Japan: About SATA HDDs

The SATA version of this server supports HDDs with SATA/BC-SATA storage interfaces. Please note that the usage and operation conditions differ depending on the type of HDD used.

For more information on the usage and operation conditions of each available type of HDD, see the following internet address:

<https://jp.fujitsu.com/platform/server/primergy/harddisk/>

Only for Japan:

Shielded LAN cables should be used in this product.

UK Importer information

Fujitsu Services Limited

22 Baker Street, London, W1U 3BW, United Kingdom

Version history

Issue number	Issue date	Description
V 1.0	02/2022	Initial release
V 2.0	08/2022	Appendix B updated Example SAS CP600i added "Resetting the error status after replacing CPUs" removed ServerView RAID manager removed "Resetting the error status after replacing memory modules" removed Supplement (04/2022) integrated in: <ul style="list-style-type: none">• Replacing the system board• Replacing iRMC microSD card• Locating the defective component• "Cleaning the dust cover" included• Looking for SAS addresses of SAS controllers for external devices• Configuration with up to two 3.5-inch HDDs• Removing 3.5-inch non hot-plug HDDs• Configuration with up to four HDD/SSD modules• Configuration with up to eight HDD/SSD modules• Configuration with up to four PCIe SSD modules
V 3.0	09/2022	Example PDUAL CP100 added

Issue number	Issue date	Description
V 4.0	12/2022	<p>The following sections were added:</p> <ul style="list-style-type: none">● Checking boot priority● Setting boot priority● Fujitsu battery unit (FJBU) <p>The following sections were updated:</p> <ul style="list-style-type: none">● Installing an expansion card● Installing an FBU● Cable plan● List of released adapters



Content

1	Introduction	19
1.1	Concept and target groups of this manual	19
1.2	Notational conventions	19
2	Before you start	21
2.1	Basic information	21
2.1.1	Proceeding.....	21
2.1.2	Advanced Thermal Design (ATD).....	21
2.1.3	Installing optional components	22
2.1.4	Replacing a defective component.....	22
2.2	Classification of procedures	23
2.2.1	Assignment of unit categories.....	23
2.2.2	Customer Replaceable Units (CRU).....	23
2.2.3	Upgrade and Repair Units (URU).....	24
2.2.4	Field Replaceable Units (FRU).....	25
2.3	Average task duration	26
2.4	Tools you need at hand	27
2.5	Documentation overview	28
2.5.1	Downloading manuals.....	28
2.5.2	List of documents.....	28
3	Important information	31
3.1	Introduction	31
3.2	Safety instructions	31
3.2.1	Basic safety instructions	31
3.2.2	Before starting up.....	32

Content

3.2.3	Installation and operation.....	32
3.2.4	Batteries.....	35
3.2.5	Working with optical disk drives (ODDs) and media.....	35
3.2.6	Laser information.....	37
3.2.7	Modules with Electrostatic-Sensitive Devices (ESD modules).....	37
3.2.8	Transporting the server.....	39
3.2.9	Installing the server in the rack.....	40
3.2.10	Other important information.....	40
3.3	ENERGY STAR	41
3.4	CE conformity	41
3.5	FCC Class A Compliance Statement	42
3.6	Environmental protection	43
4	Basic hardware procedures	45
<hr/>		
4.1	Using diagnostic information	45
4.1.1	Proceeding.....	45
4.2	Locating the defective server	45
4.3	Determining the error class	46
4.4	Locating the defective component	46
4.5	Shutting down the server	47
4.6	Disconnecting the power cord	48
4.7	Getting access to the component	50
4.7.1	Safety notes.....	50
4.7.2	Unlocking the server.....	51
4.7.3	Removing the server cover.....	52
4.7.4	Removing the accessible drive bay cover.....	54
4.7.5	Removing the HDD bay cover.....	55

4.8	Reassembling	56
4.8.1	Safety notes	56
4.8.2	Installing the server cover.....	56
4.8.3	Installing the HDD bay cover.....	57
4.8.4	Installing the accessible drive bay cover.....	57
4.9	Connecting the power cord	59
4.9.1	Connecting the power cord (standard PSU, with cable tie).....	59
4.9.2	Connecting the power cord (hot-plug PSU).....	61
4.10	Switching on the server	63
4.11	Handling the 2.5-inch HDD cage	63
4.11.1	Removing the 2.5-inch HDD cage.....	63
4.11.2	Installing the 2.5-inch HDD cage.....	65
4.12	Handling the HDD fan modules	67
4.12.1	Removing the HDD fan module (3.5-inch HDD variant).....	67
4.12.2	Installing the HDD fan module (3.5-inch HDD variant).....	68
4.12.3	Removing the HDD fan module (2.5-inch HDD variant).....	70
4.12.4	Installing the HDD fan module (2.5-inch HDD variant).....	71
5	Basic software procedures	73
5.1	Validation	73
5.2	Starting the maintenance task	73
5.2.1	Suspending BitLocker functionality.....	73
5.2.2	Disabling the boot watchdog.....	74
5.2.3	Removing backup and optical disk media	76
5.2.4	Verifying and configuring the backup software solution	76
5.2.5	Switching on the ID indicator	76
5.2.6	Checking boot priority	77
5.3	Completing the maintenance task	78
5.3.1	Updating or recovering the BIOS and iRMC S6.....	78
5.3.2	Verifying system information backup or restore	80
5.3.3	Updating expansion card firmware.....	81
5.3.4	Reconfiguring the backup software solution.....	82
5.3.5	Resetting the boot retry counter	83

Content

5.3.6	Enabling the boot watchdog	85
5.3.7	Enabling replaced components in the BIOS.....	86
5.3.8	Verifying the system time settings	86
5.3.9	Viewing and clearing the System Event Log (SEL).....	87
5.3.10	Updating the NIC configuration file in a Linux and VMware environment	89
5.3.11	Resuming BitLocker functionality.....	90
5.3.12	Performing a RAID array rebuild.....	91
5.3.13	Looking for MAC/WWN/GUID and SAS addresses	92
5.3.13.1	Basic information.....	92
5.3.13.2	Looking for the MAC address of a LAN controller.....	92
5.3.13.3	Looking for the WWN address of a fibre channel controller.....	93
5.3.13.4	Looking for the GUID address of an infiniband or Omni-Path controller.....	94
5.3.13.5	Looking for SAS addresses of SAS controllers for external devices.....	94
5.3.14	Using the Chassis ID Prom Tool.....	95
5.3.15	Configuring LAN teaming.....	97
5.3.16	Switching off the ID indicator	98
5.3.17	Performing a fan test.....	99
5.3.18	Setting boot priority.....	100
6	Power supply unit (PSU)	101
6.1	Safety notes	101
6.2	Basic information.....	101
6.3	Standard power supply	102
6.3.1	Replacing the standard PSU	102
6.3.2	Converting a standard power supply to a redundant power supply.....	108
6.4	Redundant power supply.....	115
6.4.1	Installing a hot-plug PSU	115
6.4.2	Removing a hot-plug PSU	119
6.4.3	Replacing a hot-plug PSU	121
6.4.4	Replacing the power distribution board	123

6.5	Fujitsu battery unit (FJBU)	131
6.5.1	Installing an FJBU.....	131
6.5.2	Removing an FJBU.....	132
6.5.3	Replacing an FJBU.....	134
7	Hard disk drive (HDD) / solid state drive (SSD)	135
<hr/>		
7.1	Safety notes	135
7.2	Basic information	136
7.3	Handling HDDs or SSDs without installation frame	137
7.3.1	2.5-inch HDD/SSD and 2.5-inch installation frame	137
7.4	3.5-inch HDD configurations	139
7.4.1	Configuration with up to two 3.5-inch HDDs.....	139
7.4.2	Installing 3.5-inch non hot-plug HDDs.....	140
7.4.3	Removing 3.5-inch non hot-plug HDDs.....	145
7.4.4	Replacing a 3.5-inch non hot-plug HDD.....	150
7.5	2.5-inch HDD/SSD configurations	152
7.5.1	Configuration with up to four HDD/SSD modules.....	152
7.5.2	Configuration with up to eight HDD/SSD modules.....	152
7.5.3	Configuration with up to four PCIe SSD modules	153
7.5.4	Installing 2.5-inch HDD/SSD modules.....	154
7.5.5	Removing 2.5-inch HDD/SSD modules.....	156
7.5.6	Replacing a 2.5-inch HDD/SSD module.....	159
7.5.7	Replacing a 2.5-inch backplane.....	161
7.5.8	Upgrading configuration from up to four to up to eight 2.5-inch HDDs/SSDs	169
7.5.9	Upgrading to 4x PCIe 2.5-inch SSD configuration.....	171
8	Fans	175
<hr/>		
8.1	Safety notes	175
8.2	Basic information	175

Content

8.3	Replacing the HDD fan (3.5-inch HDD variant)	177
8.4	Replacing the HDD fan (2.5-inch HDD variant)	180
9	Expansion cards and backup units	185
9.1	Safety notes	185
9.2	Basic information	186
9.3	Handling slot brackets	187
9.3.1	Installing slot brackets.....	187
9.3.2	Removing slot brackets.....	190
9.4	Handling SFP+ transceiver modules	190
9.4.1	Installing SFP+ transceiver modules.....	190
9.4.2	Removing SFP+ transceiver modules.....	196
9.5	Expansion cards	199
9.5.1	Installing expansion cards	199
9.5.2	Removing expansion cards	210
9.5.3	Replacing expansion cards.....	213
9.6	Flash backup unit (FBU)	216
9.6.1	Position of the FBU.....	216
9.6.2	Installing an FBU.....	217
9.6.3	Removing an FBU.....	225
9.6.4	Replacing an FBU.....	229
10	Main memory	231
10.1	Safety notes	231
10.2	Basic information	232
10.2.1	Slots and features.....	232
10.2.2	General memory population rules.....	232
10.2.3	Modes of operation	233
10.3	Installing memory modules	233

10.4	Removing memory modules.....	236
10.5	Replacing memory modules.....	237
11	Processor (CPU).....	239
<hr/>		
11.1	Safety notes.....	239
11.2	Basic information.....	239
11.3	Upgrading or replacing the CPU.....	240
11.4	Replacing the heat sink.....	253
12	Accessible drives.....	255
<hr/>		
12.1	Safety notes.....	255
12.2	Basic information.....	255
12.3	Optical disk drive (ODD).....	256
12.3.1	Installing the ODD.....	256
12.3.2	Removing the ODD.....	262
12.3.3	Replacing the ODD.....	265
12.4	RDX drive.....	267
12.4.1	Installing the RDX drive.....	267
12.4.2	Removing the RDX drive.....	271
12.4.3	Replacing the RDX drive.....	274
13	Front panel.....	277
<hr/>		
13.1	Safety notes.....	277
13.2	Replacing the front panel module.....	277

Content

14	Front USB connector.....	283
14.1	Installing a front USB connector.....	283
14.2	Removing a front USB connector.....	286
14.3	Replacing a front USB connector	289
15	Serial interface	291
15.1	Safety notes	291
15.2	Installing the serial interface.....	291
15.3	Removing the serial interface.....	294
15.4	Replacing the serial interface.....	295
16	Dust cover.....	297
16.1	Safety notes.....	297
16.2	Basic information.....	298
16.3	Installing the dust covers	298
16.4	Removing the dust covers.....	302
16.5	Replacing the dust covers.....	305
16.6	Cleaning the dust covers.....	306
17	System board and components.....	309
17.1	Safety notes	309
17.2	Basic information	309

17.3	CMOS battery	310
17.3.1	Replacing the CMOS battery.....	310
17.4	Trusted Platform Module (TPM)	312
17.4.1	Position of the TPM.....	312
17.4.2	TPM kit.....	313
17.4.3	Installing the TPM	313
17.4.4	Removing the TPM	316
17.4.5	Replacing the TPM	321
17.5	iRMC microSD card	323
17.5.1	Note for embedded Lifecycle Management (eLCM)	323
17.5.2	Installing the iRMC microSD card.....	323
17.5.3	Removing the iRMC microSD card.....	325
17.5.4	Replacing the iRMC microSD card.....	326
17.6	M.2 SSD	328
17.6.1	Slots and bolts for M.2 SSDs.....	328
17.6.2	Installing an M.2 SSD	330
17.6.3	Removing an M.2 SSD	335
17.6.4	Replacing an M.2 SSD.....	338
17.7	Dual microSD 64GB Enterprise	340
17.7.1	Position of the Dual microSD 64GB Enterprise.....	340
17.7.2	Installing the Dual microSD 64GB Enterprise	340
17.7.3	Removing the Dual microSD 64GB Enterprise	343
17.7.4	Replacing the Dual microSD 64GB Enterprise.....	344
17.7.5	Replacing the microSD card.....	347
17.8	System board	348
17.8.1	Replacing the system board	348
18	Appendix A	361

18.1	Mechanical overview	361
18.1.1	Server front	361
18.1.2	Server rear	363
18.1.3	Server interior.....	365

Content

18.2	Connectors and indicators	368
18.2.1	Connectors and indicators on the system board.....	368
18.2.1.1	Connectors and indicators on the system board.....	368
18.2.2	Server front	373
18.2.2.1	Connectors on the server front.....	373
18.2.2.2	Indicators on the front panel.....	374
18.2.2.3	States of power-on indicator and time duration during firmware automatic version adjustment.....	377
18.2.2.4	Indicator on the ODD.....	377
18.2.2.5	Indicators on the RDX drive.....	378
18.2.2.6	Indicators on hot-plug HDD / SSD / PCIe SSD modules	379
18.2.3	Server rear	381
18.2.3.1	Connectors on the server rear.....	381
18.2.3.2	ID, CSS and Global Error indicators.....	382
18.2.3.3	LAN indicators.....	384
18.2.3.4	Indicator on hot-plug PSU.....	385
18.3	Acoustic indicators	386
18.4	Onboard settings	387
18.5	Minimum startup configuration	388
19	Appendix B	391
19.1	Supplied documents	391

1 Introduction

1.1 Concept and target groups of this manual

This upgrade and maintenance manual provides instructions for the following procedures:

- Upgrading the server configuration by adding optional hardware components.
- Upgrading the server configuration by replacing existing hardware components with superior ones.
- Replacing defective hardware components.

This manual focuses on on-site maintenance tasks. It is recommended to prepare each service assignment following remote diagnostics procedures, as described in the "ServerView Suite Local Service Concept (LSC)" manual, see ["Documentation overview" on page 28](#).



CAUTION

The document at hand comprises procedures of a wide range of complexity.







- ▶ Check the profile of qualification for technicians before assigning tasks.
- ▶ Before you start, carefully read ["Classification of procedures" on page 23](#).

1.2 Notational conventions

The following notational conventions are used in this manual:

Text in bold	Indicates references to names of interface elements.
Text in monospace	Indicates commands and text to be entered by the user.

Introduction

"Quotation marks"	Indicate names of chapters and terms that are being emphasized.
▶	Describes activities that must be performed in the order shown.
[Abc]	Indicates keys on the keyboard.
 CAUTION	Pay particular attention to texts marked with this symbol. Failure to observe this warning may endanger your life, destroy the system or lead to the loss of data.
	Indicates additional information, notes and tips.
  	Indicates the procedure category in terms of complexity and qualification requirements, see "Classification of procedures" on page 23 .
	Indicates the average task duration, see "Average task duration" on page 26 .

2 Before you start

2.1 Basic information

2.1.1 Proceeding

Before you start any upgrade or maintenance task, proceed as follows:

- ▶ Carefully read the safety instructions, see "[Important information](#)" on [page 31](#).
- ▶ Make sure that all necessary manuals are available, see "[Documentation overview](#)" on [page 28](#). Print the PDF files if required.
- ▶ Make yourself familiar with the procedure categories, see "[Classification of procedures](#)" on [page 23](#).
- ▶ Ensure that all required tools are available, see "[Tools you need at hand](#)" on [page 27](#).

2.1.2 Advanced Thermal Design (ATD)

The ATD option allows you to operate the system with a wider temperature range either of 5 °C to 40 °C or 5 °C to 45 °C, depending on your system and configuration.

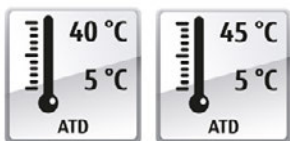

This option can only be ordered from the manufacturer and is indicated by the respective logo on the identification rating plate.



CAUTION

- ▶ In a system that is configured with ATD, only certain components which support the respectively increased higher operating temperature range may be installed and used. For applicable restrictions, see the official configurator tool.

2.1.3 Installing optional components

The operating manual of your server gives an introduction to server features and provides an overview of available hardware options.

Use the Fujitsu ServerView Suite management software and the iRMC S6 web interface to prepare hardware expansions. For more information about ServerView Suite documentation, see "[Documentation overview](#)" on page 28.

Please see the following ServerView Suite topics:

- Operation
- Virtualization
- Maintenance
- Out-Of-Band Management



For the latest information on hardware options, see the hardware configurator of your server, available online at the following address:
<https://www.fujitsu.com/fts/products/computing/servers/primergy/index.html>

For Japan:

<https://jp.fujitsu.com/platform/server/primergy/system/> (models on sale)
<https://jp.fujitsu.com/platform/server/primergy/product-navi/> (past models)

Please contact your sales outlet for details on how to order expansion kits or spare parts.

2.1.4 Replacing a defective component

The Global Error indicator on the front of the server reports defective hardware components that need to be replaced. For more information on the controls and indicators of your server, see the operating manual of your server and "[Connectors and indicators](#)" on page 368.

If the system has been powered off in order to replace a non-hot plug unit, a system of PRIMERGY diagnostic indicators guides you to the defective component. The "Indicate CSS" button enables the indicator next to the defective component even if the server has been switched off and

disconnected from the mains. For more information, see "[Using diagnostic information](#)" on page 45 and "[Indicators on the front panel](#)" on page 374.

If the defective component is a customer replaceable unit included in the CSS concept (Customer Self Service), the CSS indicator on the server front will light up.

It is recommended to prepare local maintenance tasks using remote diagnostics procedures, see the "ServerView Suite Local Service Concept (LSC)" manual.

2.2 Classification of procedures

2.2.1 Assignment of unit categories

The complexity of maintenance procedures varies significantly. Procedures have been assigned to one of three unit categories, indicating the level of difficulty and required qualification.

At the beginning of each procedure, the involved unit category is indicated by one of the symbols introduced in this section.



Please ask your local Fujitsu service center for more information.

2.2.2 Customer Replaceable Units (CRU)



Customer Replaceable Units (CRU)

Customer Replaceable Units are intended for customer self service and may be installed or replaced as hot-plug components during operation.



Components that the customer is entitled to replace may differ according to the service form in his country.

For Japan:

<https://www.fujitsu.com/jp/products/computing/servers/primergy/support/repair.html>

Before you start

Hot-plug components increase system availability and guarantee a high degree of data integrity and fail-safe performance. Procedures can be carried out without shutting down the server or going offline.

Components that are handled as Customer Replaceable Units

- Hot-plug HDD/SSD modules
- Hot-plug PCIe SSD modules
- Hot-plug PSUs
- Hot-plug fan modules
- Memory modules (not allowed for Japan)
- Expansion cards (not allowed for Japan)

Peripherals that are handled as Customer Replaceable Units

- Keyboard
- Mouse

2.2.3 Upgrade and Repair Units (URU)



Upgrade and Repair Units (URU)

Upgrade and Repair Units are non hot-plug components that can be ordered separately to be installed as options (Upgrade Units) or are available to the customer through customer self service (Repair Units).

i For Japan, customer allows only upgrade. For upgrade units as customer replaceable, see:
<https://www.fujitsu.com/jp/products/computing/servers/primergy/>

i Server management error messages and diagnostic indicators on the front panel and system board will report defective Upgrade and Repair Units as customer replaceable CSS components.

Upgrade and repair procedures involve shutting down and opening the server.



CAUTION

The device may be seriously damaged or cause damage if it is opened without authorization or if repairs are attempted by unauthorized and untrained personnel.

Components that are handled as Upgrade Units

- CPU (upgrade kits)
- Expansion cards
- Flash backup units (FBU)
- iRMC microSD card
- M.2 SSDs
- Memory modules
- Dual microSD 64GB Enterprise
- Dust cover
- Serial interface
- ODD

Components that are handled solely as Repair Units

- CMOS battery
- Non hot-plug HDD/SSD

2.2.4 Field Replaceable Units (FRU)



Field Replaceable Units (FRU)

Removing and installing Field Replaceable Units involves complex maintenance procedures on integral server components. Procedures will require shutting down, opening and disassembling the server.



CAUTION

Maintenance procedures involving Field Replaceable Units must be performed exclusively by Fujitsu service personnel or technicians trained by Fujitsu. Please note that unauthorized interference with the system will void the warranty and exempt the manufacturer from all liability.

Components that are handled as Field Replaceable Units

- CPU (replacement)
- SAS/SATA HDD backplane
- PCIe SSD backplane
- Front panel module
- Front panel cable
- System board
- RDX drive
- Trusted Platform Module (TPM)
- Power distribution board (PDB)
- Non hot-plug PSUs
- Non hot-plug fan modules



Please ask your local Fujitsu service center for more information.

2.3 Average task duration



Hardware: 10 minutes

The average task duration including preliminary and concluding steps is indicated at the beginning of each procedure next to the procedure class.

The following table gives an overview of steps taken into account for calculating the average task duration.

Step	included	Explanation
Server shutdown	no	Shutdown time depends on hardware and software configuration and may vary significantly. Software tasks necessary before maintenance, see "Starting the maintenance task" on page 73.
Rack removal, disassembly	yes	Making the server available, removing the server from the rack (if applicable).
Transport	no	Transporting the server to the service table (where required) depends on local customer conditions.
Maintenance procedures	yes	Maintenance procedures including preliminary and concluding software tasks.
Transport	no	Returning the server to its installation site (where required) depends on local customer conditions.
Assembly, rack installation	yes	Reassembling the server, installing the server in the rack (if applicable).
Starting up	no	Booting time depends on hardware and software configuration and may vary significantly.

Table 1: Calculation of the average task duration

2.4 Tools you need at hand

When preparing the maintenance task, ensure that all required tools are available. You will find a list of required tools at the beginning of each procedure.

2.5 Documentation overview

2.5.1 Downloading manuals

Maintenance procedures may include references to additional documentation.

- ▶ Ensure to store all printed manuals enclosed with your server in a save place for future reference.
- ▶ When preparing the maintenance task, ensure that all required manuals are available, see 2.5.2. If applicable, download the manual from the following address:

<https://support.ts.fujitsu.com/>

For Japan:

<https://www.fujitsu.com/jp/products/computing/servers/primergy/manual/>

2.5.2 List of documents

Document	Description
"Safety Notes and Regulations" manual "安全上のご注意" for Japan	Important safety information, available online, or as a printed copy
"FUJITSU Server PRIMERGY TX1320 M5 Operating Manual"	Information how to install, set up and operate your server, available online
"FUJITSU Server PRIMERGY TX1320 M5 Upgrade and Maintenance Manual"	Instructions for upgrading the server configuration or replacing defective hardware, available online
"D3931 BIOS Setup Utility for FUJITSU Server PRIMERGY TX1320 M5 Reference Manual"	Information on configurable BIOS options and parameters, available online

Document	Description
"FUJITSU Server PRIMERGY TX1320 M5 Disassembly and Recycling Instructions"	Instructions for disassembling and recycling the server, available online
System foil	Label inside the top cover outlining connectors, indicators and jumper
ID card	<p>Various system information, such as the product name, serial number, order number, MAC addresses and DNS name (for Japan, only the product name and the serial number)</p> <p>The location of the ID card can be found in the overview of the server.</p>
iRMC S6 documentation	<ul style="list-style-type: none"> – "iRMC S6 - Concepts and Interfaces" user guide – "iRMC S6 - Configuration and Maintenance" user guide – "iRMC S6 - Web Interface" user guide
Infrastructure Manager documentation	"FUJITSU Software Infrastructure Manager V2.8.0 Infrastructure Manager for PRIMEFLEX V2.8.0 User's Guide"
ServerView documentation	<ul style="list-style-type: none"> – "ServerView Suite Local Service Concept (LSC)" user guide – "ServerView embedded Lifecycle Management (eLCM)" user guide
Illustrated Spares catalog	Spare parts identification and information system (not valid for Japan), available for online use or download (Windows OS) at https://manuals.ts.fujitsu.com/isc_illustrated_spares/ .
Glossary	Contains abbreviations and explanations, available online

Before you start

Document	Description
"Warranty" manual "保証書" for Japan	Important information on warranty regulations, recycling and service, available online, or as a printed copy
"Returning used devices" manual	Recycling and contact information, available online at https://ts.fujitsu.com/recycling , or as a printed copy
"Service Desk" leaflet "サポート & サービス" for Japan	Not applicable in Japan and other countries that have different regulations for recycling
Additional documentation	RAID documentation and "NVMe User Guide", available online at https://support.ts.fujitsu.com/ For Japan: https://www.fujitsu.com/jp/products/computing/servers/primergy/manual/
Third party documentation	<ul style="list-style-type: none">– Operating system documentation, online help– Peripherals documentation

Table 2: List of documents

3 Important information

3.1 Introduction

In this chapter you will find essential information regarding safety when working on your server.



Depending on your server or the installed options some information is not valid for your server.



CAUTION

▶ Before installing and starting up a server, please observe the safety instructions listed in the following section. This will help you to avoid making serious errors that could impair your health, damage the server and endanger the data base.

3.2 Safety instructions

3.2.1 Basic safety instructions



The following safety instructions are also provided in the manual "Safety Notes and Regulations" or "安全上のご注意".

This server meets the relevant safety regulations for IT equipment. If you have any questions about whether you can install the server in the intended environment, please contact your sales outlet or our customer service team.

- ▶ The actions described in this manual shall be performed by technical specialists. A technical specialist is a person who is trained to install the server including hardware and software.
- ▶ Repairs to the server that do not relate to CSS failures shall be performed by service personnel. Please note that unauthorized interference with the server will void the warranty and exempt the manufacturer from all liability.
- ▶ Any failure to observe the guidelines in this manual, and any improper repairs could expose the user to risks (electric shock, energy hazards, fire hazards) or damage the equipment.

Important information

- ▶ Only valid for non hot-plug components

Before installing/removing internal components to/from the server, turn off the server, all peripheral devices, and any other connected devices. Also unplug all power cords from the power outlet. Failure to do so can cause electric shock or damage.

3.2.2 Before starting up

- ▶ During installation and before operating the server, observe the instructions on environmental conditions for your server.

- ▶ If the server is brought in from a cold environment, condensation may form both inside and on the outside of the server.

Wait until the server has acclimatized to room temperature and is absolutely dry before starting it up. Material damage may be caused to the server if this requirement is not observed.

- ▶ Only transport the server in its original packaging or in packaging that protects it from impacts and jolts.

In Japan and APAC, transporting the server in its original packaging does not apply.

3.2.3 Installation and operation

- ▶ This server should not be operated in ambient temperatures above 35 °C. For servers with Advanced Thermal Design the ambient temperature can increase to 40 °C or 45 °C.

- ▶ If the server is integrated into an installation that draws power from an industrial power supply network with an IEC309 connector, the power supply's fuse protection must comply with the requirements for non-industrial power supply networks for type A connectors.

- ▶ The server automatically adjusts itself to a mains voltage, see the type label of your server. Ensure that the local mains voltage lies within these limits.

- ▶ This server must only be connected to properly grounded power outlets or connected to the grounded rack internal power distribution server with tested and approved power cords.

- ▶ If a DC power cord is used, the server must be connected to a proper DC source and earth ground stud/end.
- ▶ Ensure that the server is connected to a properly grounded power outlet close to the server.
- ▶ Ensure that the power sockets on the server and the properly grounded power outlets are easily accessible.
- ▶ The On/Off button or the main power switch (if present) does not isolate the server from the mains power supply. In case of repair or servicing disconnect the server completely from the mains power supply, unplug all power plugs from the properly grounded power outlets.
- ▶ Always connect the server and the attached peripheral devices to the same power circuit. Otherwise you run the risk of losing data if, for example, the server is still running but a peripheral device (e.g. memory subsystem) fails during a power outage.
- ▶ The adequately shielded data cables must be used.

All data and signal cables must have sufficient shielding. The use of cable type S/FTP Cat5 or higher is recommended. Use of unshielded or badly shielded cables may lead to increased emission of interference and/or reduced fault-tolerance of the device.
- ▶ Ethernet cabling has to comply with EN 50173 and EN 50174-1/2 standards or ISO/IEC 11801 standard respectively. The minimum requirement is a Category 5 shielded cable for 10/100 Ethernet, or a Category 5e cable for Gigabit Ethernet.
- ▶ Route the cables in such a way that they do not create a potential hazard (ensure that no-one can trip over them) and that they cannot be damaged. When connecting the server, see the relevant instructions in this manual.
- ▶ Never connect or disconnect data transmission lines during a storm (risk of lightning hazard).
- ▶ Ensure that no objects (e.g. jewelry, paperclips etc.) or liquids can get inside the server (risk of electric shock, short circuit).
- ▶ In emergencies (e.g. damaged casing, controls or cables, penetration of liquids or foreign bodies), contact the server administrator or your customer service team. Only disconnect the server from the mains power supply if there is no risk of harming yourself.

Important information

- ▶ Proper operation of the server (in accordance with IEC 60950-1/62368-1 resp. EN 60950-1/62368-1) is only ensured if the server is completely assembled and the rear covers for the installation slots have been fitted (electric shock, cooling, fire protection, interference suppression).
- ▶ Only install server expansions that satisfy the requirements and rules governing safety and electromagnetic compatibility and those relating to telecommunication terminals. If you install other expansions, they may damage the server or violate the safety regulations. Information on which server expansions are approved for installation can be obtained from our customer service center or your sales outlet.
- ▶ The components marked with a warning notice (e.g. lightning symbol) may only be opened, removed or exchanged by authorized, qualified personnel. Exception: CSS components can be replaced.
- ▶ The warranty is void if the server is damaged during installation or replacement of server expansions.
- ▶ Only set screen resolutions and refresh rates that are specified in the operating manual for the monitor. Otherwise, you may damage your monitor. If you are in any doubt, contact your sales outlet or customer service center.
- ▶ Only valid for non hot-plug components
Before installing/removing internal components to/from the server, turn off the server, all peripheral devices, and any other connected devices. Also unplug all power cords from the power outlet. Failure to do so can cause electric shock or damage.
Internal devices remain hot after shutdown. Wait for a while after shutdown before installing or removing internal options.
- ▶ Do not damage or modify internal cables or internal devices. Doing so may cause a server failure, fire, or electric shock and will void the warranty and exempt the manufacturer from all liability.
- ▶ The circuit boards and soldered parts of internal options are exposed and can be damaged by static electricity. To ensure reliable protection, you must wear an earthing band on your wrist when working with this type of module and connect it to an unpainted, conducting metal part of the server.
- ▶ Do not touch the circuitry on boards or soldered parts. Hold the metallic areas or the edges of the circuit boards.

- ▶ Install the screw removed during installation/detaching internal options in former position. To use a screw of the different kind can cause a breakdown of equipment.
- ▶ The procedure of installation on this notes might change depending on a configuration of option.

3.2.4 Batteries

- ▶ Incorrect replacement of batteries may lead to a risk of explosion. The batteries may only be replaced with identical batteries or with a type recommended by the manufacturer.
- ▶ Do not throw batteries into the trash can.
Batteries must be disposed of in accordance with local regulations concerning special waste.
- ▶ Ensure that you insert the battery the right way round.
- ▶ The battery used in this server may present a fire or chemical burn hazard if mistreated. Do not disassemble, heat about 100 °C (212F), or incinerate the battery.
- ▶ Replace the lithium battery on the system board in accordance with the instructions in the corresponding Upgrade and Maintenance Manual, chapter "System board and components" > "CMOS battery".
- ▶ All batteries containing pollutants are marked with a symbol (a crossed-out garbage can). In addition, the marking is provided with the chemical symbol of the heavy metal decisive for the classification as a pollutant:
Cd Cadmium
Hg Mercury
Pb Lead

3.2.5 Working with optical disk drives (ODDs) and media

When working with ODDs, these instructions must be followed.



CAUTION

- ▶ Only use CDs/DVDs/BDs that are in perfect condition, in order to prevent data loss, equipment damage and injury.
- ▶ Check each CD/DVD/BD for damage, cracks, breakages etc. before inserting it in the drive.

Note that any additional labels applied may change the mechanical properties of a CD/DVD/BD and cause imbalance and vibrations.

Damaged and imbalanced CDs/DVDs/BDs can break at high drive speeds (data loss).

Under certain circumstances, sharp CD/DVD/BD fragments can pierce the cover of the ODD (equipment damage) and can fly out of the drive (danger of injury, particularly to uncovered body parts such as the face or neck).

- ▶ High humidity and airborne dust levels are to be avoided. Electric shocks and/or server failures may be caused by liquids such as water, or metallic items, such as paper clips, entering a drive.
- ▶ Shocks and vibrations are also to be avoided.
- ▶ Do not insert any objects other than the specified CDs/DVDs/BDs.
- ▶ Do not pull on, press hard, or otherwise handle the CD/DVD/BD tray roughly.
- ▶ Do not disassemble the ODD.
- ▶ Before use, clean the ODD tray using a soft, dry cloth.
- ▶ As a precaution, remove disks from the ODD when the drive is not to be used for a long time. Keep the ODD tray closed to prevent foreign matter, such as dust, from entering the ODD.
- ▶ Hold CDs/DVDs/BDs by their edges to avoid contact with the disk surface.
- ▶ Do not contaminate the CD/DVD/BD surface with fingerprints, oil, dust, etc. If dirty, clean with a soft, dry cloth, wiping from the center to the edge. Do not use benzene, thinners, water, record sprays, antistatic agents, or silicone-impregnated cloth.
- ▶ Be careful not to damage the CD/DVD/BD surface.
- ▶ Keep the CDs/DVDs/BDs away from heat sources.

- ▶ Do not bend or place heavy objects on CDs/DVDs/BDs.
- ▶ Do not write with ballpoint pen or pencil on the label (printed) side.
- ▶ Do not attach stickers or similar to the label side. Doing so may cause rotational eccentricity and abnormal vibrations.
- ▶ When a CD/DVD/BD is moved from a cold place to a warm place, moisture condensation on the CD/DVD/BD surface can cause data read errors. In this case, wipe the CD/DVD/BD with a soft, dry cloth then let it air dry. Do not dry the CD/DVD/BD using devices such as a hair dryer.
- ▶ To avoid dust, damage, and deformation, keep the CD/DVD/BD in its case whenever it is not in use.
- ▶ Do not store CDs/DVDs/BDs at high temperatures. Areas exposed to prolonged direct sunlight or near heating appliances are to be avoided.



You can prevent damage from the ODD and the CDs/DVDs/BDs, as well as premature wear of the disks, by observing the following suggestions:

- Only insert disks in the drive when needed and remove them after use.
- Store the disks in suitable sleeves.
- Protect the disks from exposure to heat and direct sunlight.

3.2.6 Laser information

The ODD complies with IEC 60825-1 laser class 1.



CAUTION

The ODD contains a light-emitting diode (LED), which under certain circumstances produces a laser beam stronger than laser class 1. Looking directly at this beam is dangerous.

- ▶ Never remove parts of the ODD casing!

3.2.7 Modules with Electrostatic-Sensitive Devices (ESD modules)

ESD modules are identified by the following sticker:

Important information



Figure 1: ESD label



The ESD label can be different.

When you handle ESD modules, you must always observe the following points:

- ▶ Switch off the server and remove the power plugs from the power outlets before installing or removing ESD modules.
- ▶ The circuit boards and soldered parts of internal options are exposed and can be damaged by static electricity. To ensure reliable protection, you must wear an earthing band on your wrist when working with ESD modules and connect it to an unpainted, conducting metal part of the server.
- ▶ Any devices or tools that are used must be free of electrostatic charge.
- ▶ Wear a suitable grounding cable that connects you to the external chassis of the server.
- ▶ Always hold ESD modules at the edges or at the colored touch points.
- ▶ Do not touch any connectors or conduction paths on an ESD module.
- ▶ Place all the components on a pad which is free of electrostatic charge.



For a detailed description of how to handle ESD modules, see the relevant European or international standards (EN 61340-5-1, ANSI/ESD S20.20).

3.2.8 Transporting the server



CAUTION

- ▶ Only transport the server in its original packaging or in packaging that protects it from impacts and jolts.

In Japan and APAC, transporting the server in its original packaging does not apply.

- ▶ Do not unpack the server until it is at its installation location.
- ▶ If you need to lift or transport the server, ask other people to help you.
- ▶ Never lift or carry the server by the handles or the Quick Release Levers (QRLs) on the front panel.

3.2.9 Installing the server in the rack



CAUTION

- ▶ For safety reasons, at least 2 people are required to install the server in the rack because of its weight and size.
(For Japan, see "安全上のご注意".)
- ▶ Never lift the server into the rack using the Quick Release Levers (QRLs) on the front panel.
- ▶ When connecting and disconnecting cables, observe the relevant instructions in the "Important Information" chapter of the technical manual for the corresponding rack. The technical manual is supplied with the corresponding rack.
- ▶ When installing the rack, ensure that the anti-tilt mechanism is correctly fitted.
- ▶ Do not extend more than one server out of the rack simultaneously even if the tilt protection is in place. If several servers are simultaneously extended from the rack, there is a risk that the rack could tip over. See the safety information of the rack and the warning label.
- ▶ If the server/rack is intended for permanent connection to the mains only an authorized specialist (electrician) is allowed to work. Please follow the regulation of each country.
- ▶ If the server is integrated into an installation that draws power from an industrial power supply network with an IEC309 type connector, the power supply's fuse protection must comply with the requirements for non-industrial power supply networks for the type A connector.

3.2.10 Other important information

- ▶ During cleaning, observe the instructions in the corresponding operating manual chapter "Operation" > "Cleaning the server".
- ▶ Keep all manuals close to the server. All documentation must be included if the equipment is passed on to a third party.

3.3 ENERGY STAR



Products that have been certified compliant with ENERGY STAR and labelled are in full compliance with the specification at shipping. Note that energy consumption can be affected by software that is installed or any changes that are made to the hardware configuration or BIOS or energy options subsequently. In such cases, the properties guaranteed by ENERGY STAR can no longer be assured.

The "FUJITSU Software Infrastructure Manager V2.8.0 User's Guide" contains instructions for reading out measurement values, including those relating to current energy consumption and air temperatures. Either the Performance Monitor or the Task Manager can be used to read out CPU utilization levels.

3.4 CE conformity



The system complies with the requirements of European Regulations. Find the CE declaration on certificate portal: <https://sp.ts.fujitsu.com/sites/certificates/default.aspx>



CAUTION

This is a Class A product. In a domestic environment this product may cause RF interference.

- ▶ In this case the user may be required to take adequate measures.

To open the CE declaration applicable for your system, proceed as follows:

- ▶ Select the product class, e.g. "Industry Standard Servers".
- ▶ Select the subclass, e.g. "Tower servers".
- ▶ Select your server, e.g. "PRIMERGY TX1320 M5".
- ▶ Select the document, e.g. "CE Cert PRIMERGY TX1320 M5".

3.5 FCC Class A Compliance Statement

If there is an FCC statement on the device, it applies to the products covered in this manual, unless otherwise specified herein. The statement for other products will appear in the accompanying documentation.

NOTE:

This equipment has been tested and found to comply with the limits for a "Class A" digital device, pursuant to Part 15 of the FCC rules and meets all requirements of the Canadian Interference-Causing Equipment Standard ICES-003 for digital apparatus. These limits are designed to provide reasonable protection against harmful interference in a residential installation. This equipment generates, uses and can radiate radio frequency energy and, if not installed and used in strict accordance with the instructions, may cause harmful interference to radio communications. However, there is no warranty that interference will not occur in a particular installation. If this equipment does cause harmful interference to radio or television reception, which can be determined by turning the equipment off and on, the user is encouraged to try to correct the interference by one or more of the following measures:

- ▶ Reorient or relocate the receiving antenna.
- ▶ Increase the separation between equipment and the receiver.
- ▶ Connect the equipment into an outlet on a circuit different from that to which the receiver is connected.
- ▶ Consult the dealer or an experienced radio/TV technician for help.

Fujitsu is not responsible for any radio or television interference caused by unauthorized modifications of this equipment or the substitution or attachment of connecting cables and equipment other than those specified by Fujitsu. The correction of interferences caused by such unauthorized modification, substitution or attachment will be the responsibility of the user.

The use of shielded I/O cables is required when connecting this equipment to any and all optional peripheral or host devices. Failure to do so may violate FCC and ICES rules.

3.6 Environmental protection

Environmentally-friendly product design and development

This product has been designed in accordance with the Fujitsu standard for "environmentally friendly product design and development". This means that key factors such as durability, selection and labeling of materials, emissions, packaging, ease of dismantling and recycling have been taken into account. This saves resources and thus reduces the harm done to the environment. More information can be found at:

https://ts.fujitsu.com/products/standard_servers/index.html

For Japan:

<https://jp.fujitsu.com/platform/server/primergy/concept/>

Energy-saving information

Devices that do not need to be constantly switched on should be switched off until they are needed as well as during long breaks and after completion of work.

Packaging information

This packaging information does not apply in Japan and APAC. Do not throw away the packaging. You may need it later for transporting the server. If possible, the equipment should only be transported in its original packaging.

Information on handling consumables

Please dispose of printer consumables and batteries in accordance with the applicable national regulations.

In accordance with EU directives, batteries must not be disposed of with unsorted domestic waste. They can be returned free of charge to the manufacturer, dealer or an authorized agent for recycling or disposal.

All batteries containing pollutants are marked with a symbol (a crossed-out garbage can). They are also marked with the chemical symbol for the heavy metal that causes them to be categorized as containing pollutants:

Cd Cadmium

Hg Mercury

Pb Lead

Important information

Labels on plastic casing parts

Please avoid sticking your own labels on plastic parts wherever possible, since this makes it difficult to recycle them.

Returns, recycling and disposal

Please handle returns, recycling and disposal in accordance with local regulations.



The device must not be disposed of with domestic waste. This device is labeled in compliance with European directive 2012/19/EU on waste electrical and electronic equipment (WEEE).

This directive sets the framework for returning and recycling used equipment and is valid across the EU. When returning your used device, please use the return and collection systems available to you.

More information can be found at:

<https://ts.fujitsu.com/recycling>

Details regarding the return and recycling of devices and consumables within Europe can also be found in the "Returning used devices" manual, via your local Fujitsu branch, or at:

<https://ts.fujitsu.com/recycling>

4 Basic hardware procedures

4.1 Using diagnostic information

4.1.1 Proceeding

Use the Fujitsu ServerView Suite management software to plan the upgrade or replacement of hardware components.

It is recommended to prepare local maintenance tasks using remote diagnostics procedures, see the "ServerView Suite Local Service Concept (LSC)" manual.



In Japan remote diagnostics procedures are not used.

Please contact your sales outlet for details on the service concept and on how to order expansion kits or spare parts.

4.2 Locating the defective server

Use the ID indicator for easy identification of the server, especially when working in a datacenter environment or a server room:

- ▶ Press the ID button on the front panel, use the iRMC S6 web interface or Infrastructure Manager to switch on the system identification LEDs.



For more information, see the "ServerView Suite Local Service Concept (LSC)" manual, the iRMC user guides or the Infrastructure Manager documentation.

- ▶ Remember to switch off the ID indicator after the maintenance task has been concluded successfully.

Using the Infrastructure Manager

- ▶ To toggle the ID indicator from the Infrastructure Manager, select a node from the **Node List** screen and operate the ID indicator from the **Action** button.

4.3 Determining the error class

The Local Service Concept (LSC) allows you to identify defective server components. Failure events are assigned to one of two error classes:

- Global Error (for non CSS components) events that need to be resolved by maintenance personnel
- Customer Self Service (for CSS components) error events that may be resolved by operating personnel

The Global Error indicator and the CSS indicator can be found on the front side and the rear side of the server.

 In some cases the indicator on the rear is designed as a combined indicator (Global Error, ID and CSS indicator).

 The indicators also light up in standby mode and after a server restart due to a power failure.

- ▶ Check the Global Error indicator and the CSS indicator.

4.4 Locating the defective component

After determining the error class by the CSS indicator or the Global Error indicator, indicators on the components and onboard indicators on the system board allow you to identify the defective component, see ["Determining the error class" on page 46](#).

Possibilities to get more information about the defective component

- Checking the System Event Log (SEL), see ["Viewing the SEL using the IRMC S6 web interface" on page 88.](#)
- Checking the indicators on the components, see ["Connectors and indicators" on page 368.](#)
- Checking the onboard indicators on the system board using the Indicate CSS button, see ["Using the CSS button on the system board" on page 47.](#)

Using the CSS button on the system board

If the system has been powered off, the onboard indicators guides you to the defective component.



CAUTION

It is mandatory to disconnect all power cords from the system in order to use the Indicate CSS functionality.

- ▶ Shut down and switch off the server.
- ▶ Disconnect all power cords from the system.
- ▶ Press the Indicate CSS button to highlight defective components. The indicator next to the defective component lights up.

4.5 Shutting down the server



CAUTION

- ▶ For more information, see ["Important information" on page 31.](#)



This step is only required when upgrading or replacing non-hot-plug components.

- ▶ Inform the system administrator that the server will be shut down and put offline.
- ▶ Terminate all applications.
- ▶ Perform the required procedures described in the preliminary steps of each upgrade or maintenance task.

- ▶ Shut down the server.



If the system is running an ACPI-compliant operating system (OS), pressing the On/Off button will perform a graceful shutdown.

- ▶ Switch on the ID indicator on the front panel and I/O panel of the server, see ["Locating the defective server" on page 45](#).

4.6 Disconnecting the power cord

Standard power supply

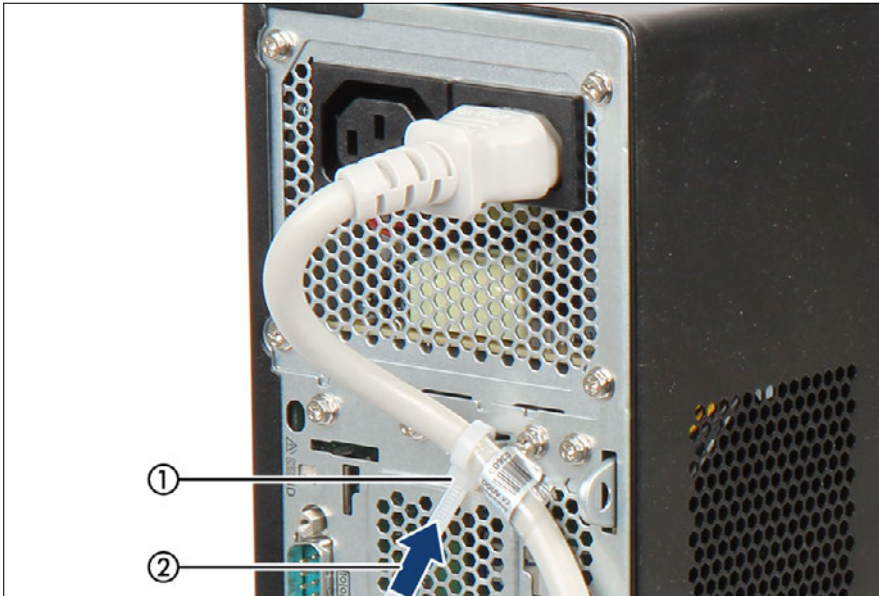

Figure 2: Removing the power cord from the PSU cable tie

- ▶ Pull out the locking lever on the PSU cable tie(s) (1) and loosen the loop (2).
- ▶ Disconnect the power cord from the PSU and remove it from the cable tie.

Redundant power supply



Figure 3: Unlocking the cable clamp of a PSU

- ▶ Press the cable clamp down until it disengages (1).
- ▶ Open the cable clamp (2).
- ▶ Disconnect the power cord from the PSU and remove it from the cable clamp.

4.7 Getting access to the component

4.7.1 Safety notes



CAUTION

- ▶ Only for non-hot plug components:
 - Before removing or attaching covers, turn off the server, all peripheral devices, and any other connected devices.
 - Because there is a risk of electric shock or damage, please disconnect all power cords from the outlet.
- ▶ The top cover must be replaced as soon as possible for purposes of cooling, to comply with EMC regulations (regulations regarding electromagnetic compatibility) and to prevent fires.
- ▶ For more information, see "[Important information](#)" on page 31.
- ▶ **Only valid for the floorstand model:** Do not lift the server by the front cover in order not to damage the locking clips.

4.7.2 Unlocking the server

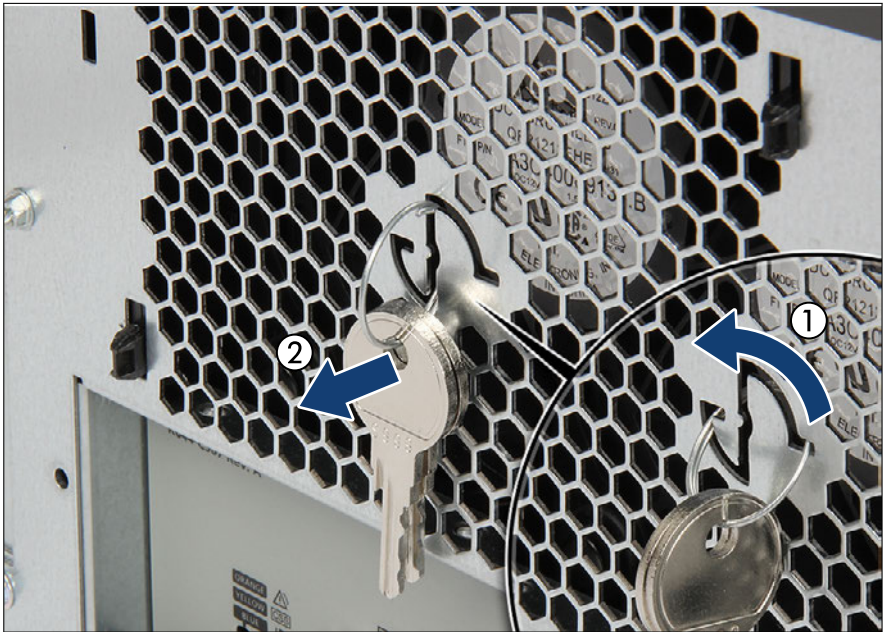

Figure 4: Removing the key

- ▶ If applicable, remove the adhesive tape from the keychain on the server rear.
- ▶ Turn the keychain counterclockwise by 90 degrees (1).
- ▶ Remove the keychain from the server rear (2).

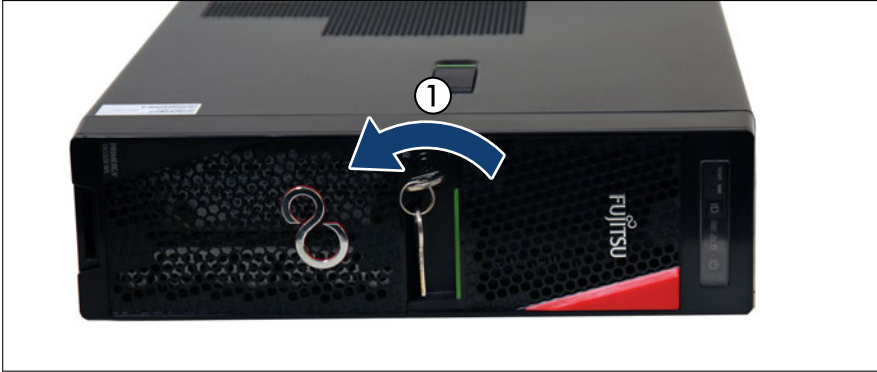

Figure 5: Unlocking the server

- ▶ Insert the key into the lock on the HDD bay cover.
- ▶ Turn the key counterclockwise to unlock the drive covers (1).
- ▶ Remove the key from the HDD bay cover and set aside for later use.

4.7.3 Removing the server cover

- ▶ Remove all external cables from the I/O panel and expansion cards. For more information, see ["Connectors and indicators" on page 368](#).



Figure 6: Removing the ID card

- ▶ Remove the ID card (1) from the server.



It may be necessary to pull out the ID card rather firmly. However, do not apply excessive force.

- ▶ Remove the accessible drive bay cover, see ["Removing the accessible drive bay cover" on page 54](#).
- ▶ Remove the HDD bay cover, see ["Removing the HDD bay cover" on page 55](#).

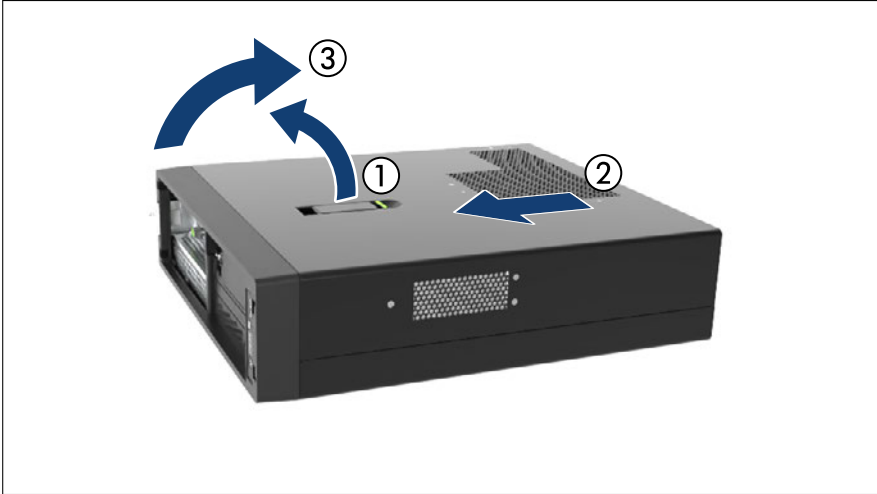

Figure 7: Removing the server cover

- ▶ Open the locking lever up (1).
- ▶ Slide the server cover towards the front as far as it will go (2).
- ▶ Remove the server cover in a vertical motion (3).

4.7.4 Removing the accessible drive bay cover

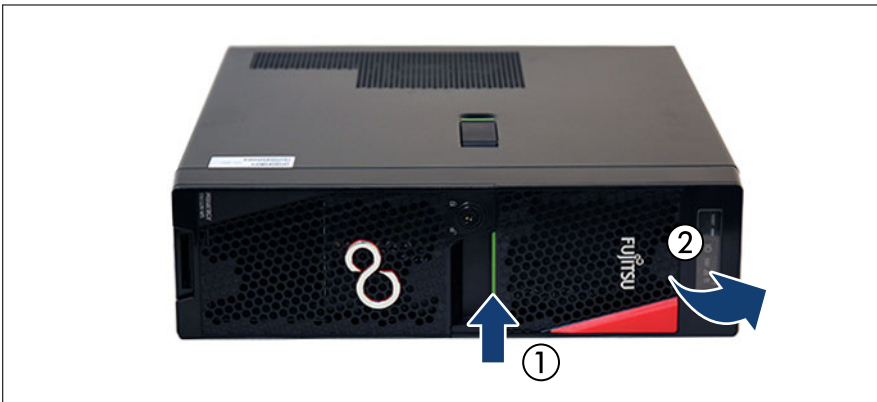

Figure 8: Removing the accessible drive bay cover

- ▶ If applicable, unlock the server, see ["Unlocking the server" on page 51](#).
- ▶ Pull the green locking bar (1) and fold out the accessible drive bay cover.
- ▶ Remove the accessible drive bay cover (2).



CAUTION

- ▶ Do not pull too hard to avoid damage to the locking mechanism.



When operating with tape drives:

If the system is programmed to eject the media automatically, the accessible drives must not be obstructed.

The accessible drive bay cover is replaced and the server locked in the reverse order.

4.7.5 Removing the HDD bay cover



Figure 9: Removing the HDD bay cover

- ▶ If applicable, unlock the server, see ["Unlocking the server" on page 51](#).
- ▶ Fold out the HDD bay cover.
- ▶ Remove the HDD bay cover (1).

The HDD bay cover is replaced and the server locked in the reverse order.

4.8 Reassembling

4.8.1 Safety notes



CAUTION

- ▶ Before attaching the covers, make sure no unnecessary parts or tools are left inside the server.
- ▶ The top cover must be replaced as soon as possible for purposes of cooling, to comply with EMC regulations (regulations regarding electromagnetic compatibility) and to prevent fires.
- ▶ For more information, see ["Important information" on page 31](#).

4.8.2 Installing the server cover

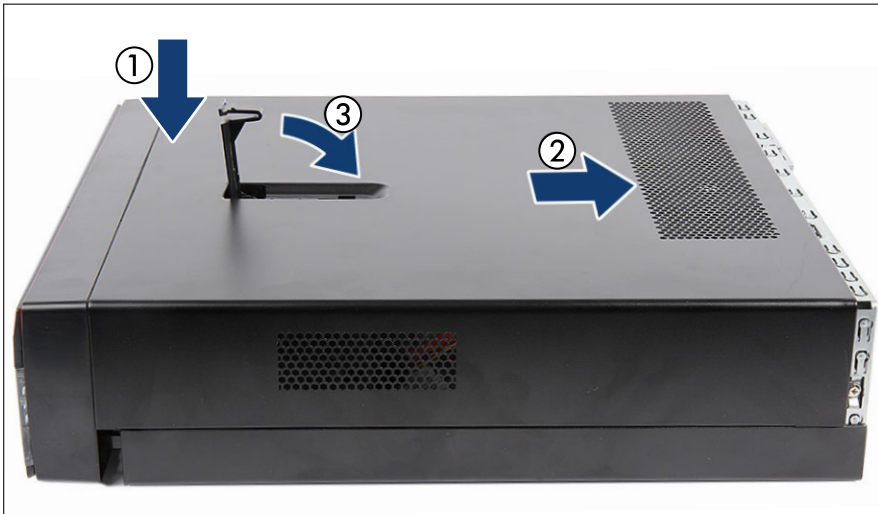

Figure 10: Closing the server cover

- ▶ Fit the server cover on the chassis (1).
- ▶ Slide the server cover towards the rear until the locking lever grips (2).
- ▶ Fold down the locking lever (3).

4.8.3 Installing the HDD bay cover

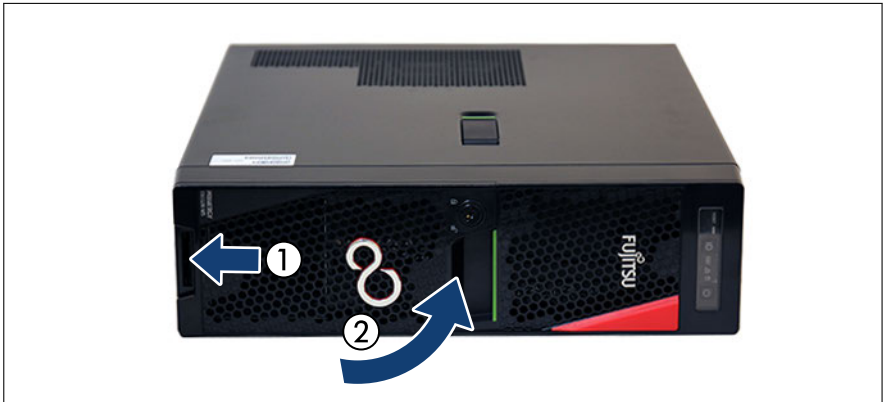

Figure 11: Installing the HDD bay cover

- ▶ Insert the HDD bay cover with the lower side into the server cover (1).
- ▶ Close the HDD bay cover (2).

4.8.4 Installing the accessible drive bay cover

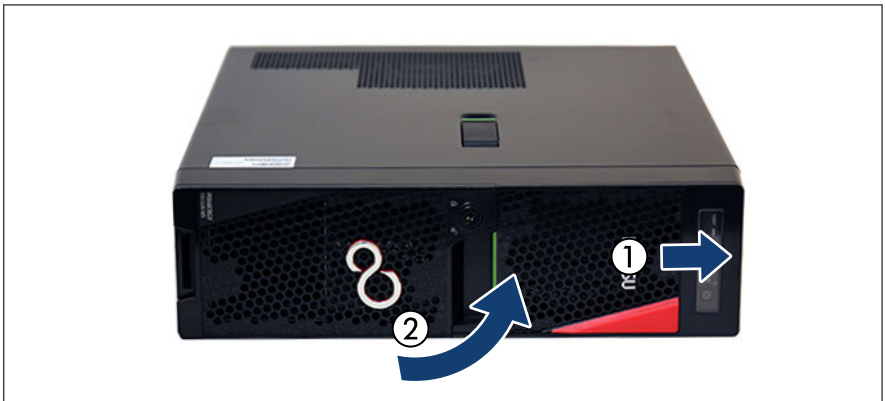

Figure 12: Installing the accessible drive bay cover

Basic hardware procedures

- ▶ Insert the accessible drive bay cover to the upper side of the server cover (1).
- ▶ Close the accessible drive bay cover (2).
- ▶ Turn the key clockwise.



Depending on the setting of the green hook in the accessible drive bay cover, you can open the accessible drive bay cover without turning the key or only with turning the key.



Figure 13: Installing the ID card

- ▶ Insert and slide the ID card (1) into its slot until it locks in place.

4.9 Connecting the power cord

4.9.1 Connecting the power cord (standard PSU, with cable tie)



CAUTION

The server automatically adjusts to a mains voltage in the range from 100 V - 240 V.

- ▶ You may only operate the server if its rated voltage range corresponds to the local mains voltage.
- ▶ Connect the power cord to the PSU.
- ▶ Connect the mains connector to a grounded mains outlet in the in-house power supply network.



You can secure the power cord using a cable tie to ensure that the insulated connector cannot be disconnected from the server accidentally. The cable tie is included in the accessories pack that is delivered together with the server.

Using a cable tie

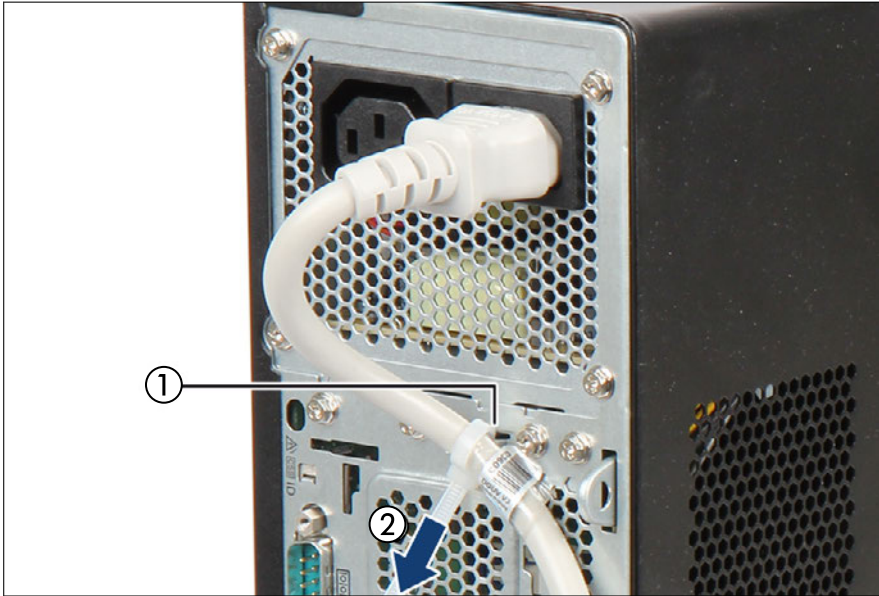

Figure 14: Securing power cord

- ▶ Thread the cable tie through the eye (1).
- ▶ Pull the cable tie tight to secure the power cable (2).

The insulated connector cannot now be disconnected from the server accidentally.

You can loosen the cable tie by opening the small locking lever (2).



It will take about 60 seconds until the server can be powered on.

4.9.2 Connecting the power cord (hot-plug PSU)



CAUTION

The server automatically adjusts to a mains voltage in the range from 100 V - 240 V.

- ▶ You may only operate the server if its rated voltage range corresponds to the local mains voltage.
- ▶ Connect the power cord to the PSU.
- ▶ Connect the mains connector to a grounded mains outlet in the in-house power supply network.
- ▶ Ensure that the status indicator on the PSU is lit green, see ["Indicator on hot-plug PSU" on page 385](#).



You can secure the power cord with a cable clamp to ensure that the power cord cannot be disconnected from the server by mistake. The cable clamp is included in the accessories pack that is delivered together with the server.

Using a cable clamp

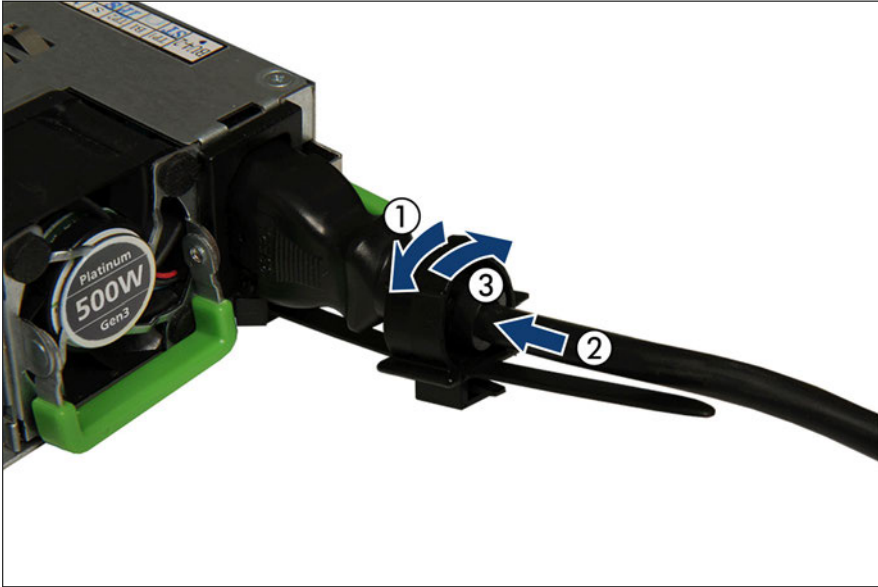

Figure 15: Locking the cable clamp of a PSU

- ▶ Pull the cable clamp up (1).
- ▶ Thread the power cord through the cable clamp (2).
- ▶ Press the cable clamp down until it engages to secure the cable (3).



It will take about 60 seconds until the server can be powered on.

4.10 Switching on the server



CAUTION

- ▶ Before switching on the server, make sure the side cover is closed. In order to comply with applicable EMC regulations (regulations on electromagnetic compatibility) and satisfy cooling requirements, the server must not run while the side cover is removed.
- ▶ For more information, see "[Important information](#)" on page 31.
- ▶ Press the On/Off button to start up the server.
- ▶ Ensure that the power-on indicator is lit green.

4.11 Handling the 2.5-inch HDD cage

4.11.1 Removing the 2.5-inch HDD cage

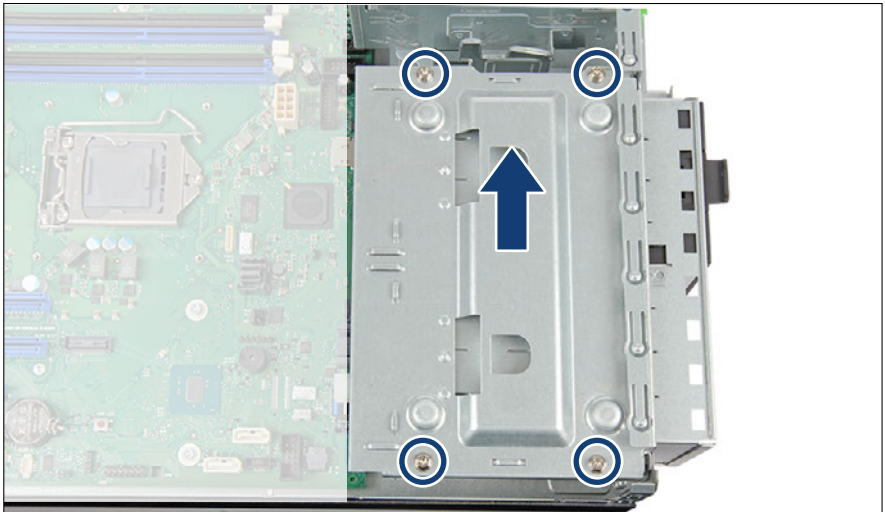

Figure 16: Removing the HDD cage (A)

- ▶ Remove the four screws (see circles).
- ▶ Remove the cover from the HDD cage.

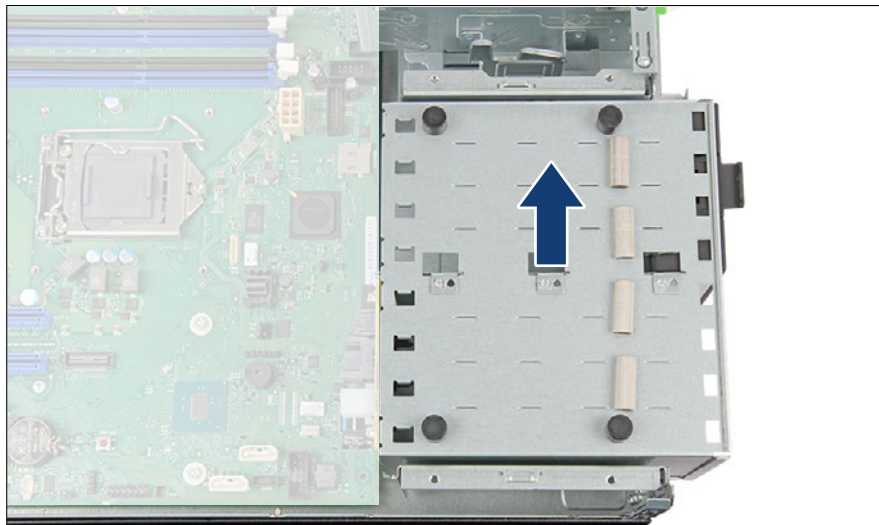

Figure 17: Removing the HDD cage (B)

- Lift the HDD cage out of the chassis.

4.11.2 Installing the 2.5-inch HDD cage

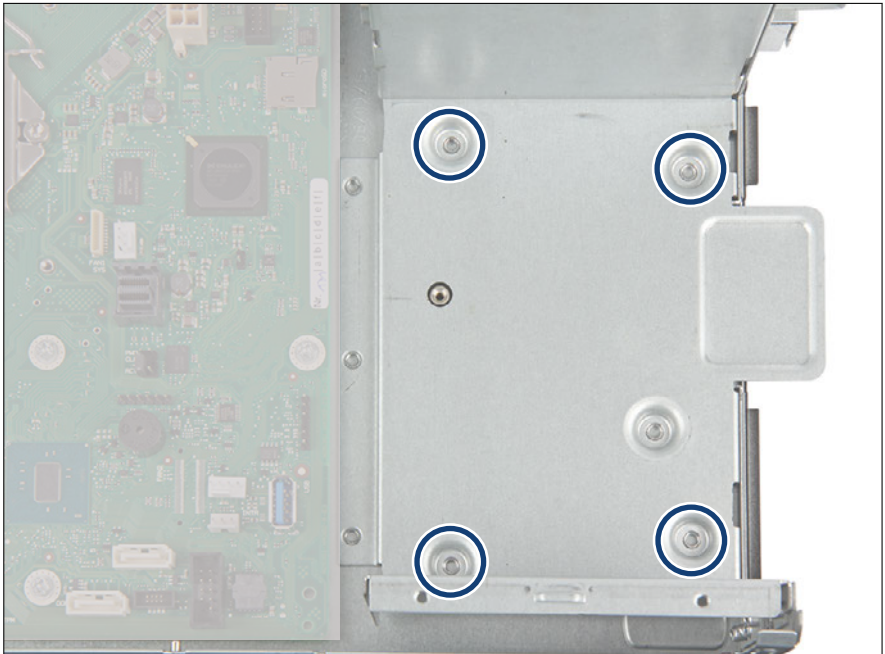

Figure 18: Recesses for the HDD cage

- Note the designated recesses for the HDD cage (see circles).

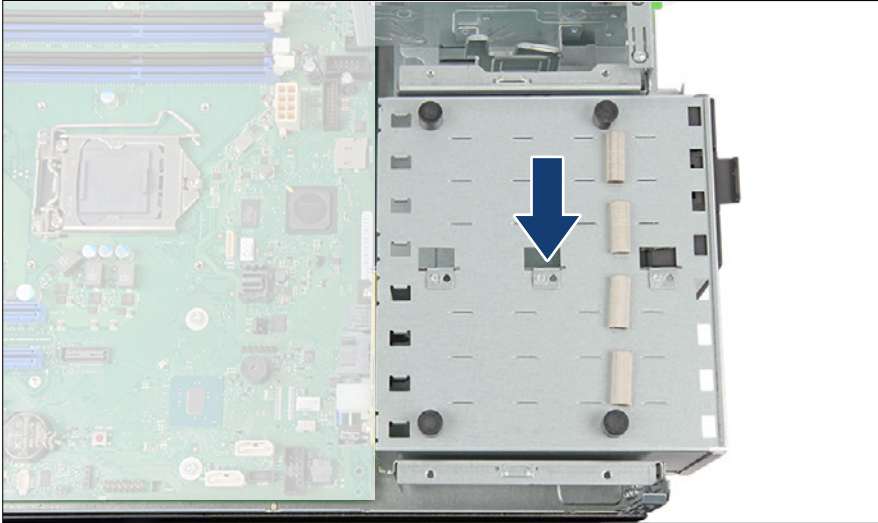

Figure 19: Installing the HDD cage (A)

- ▶ Place the HDD cage with its rubber feet into the designated recesses.

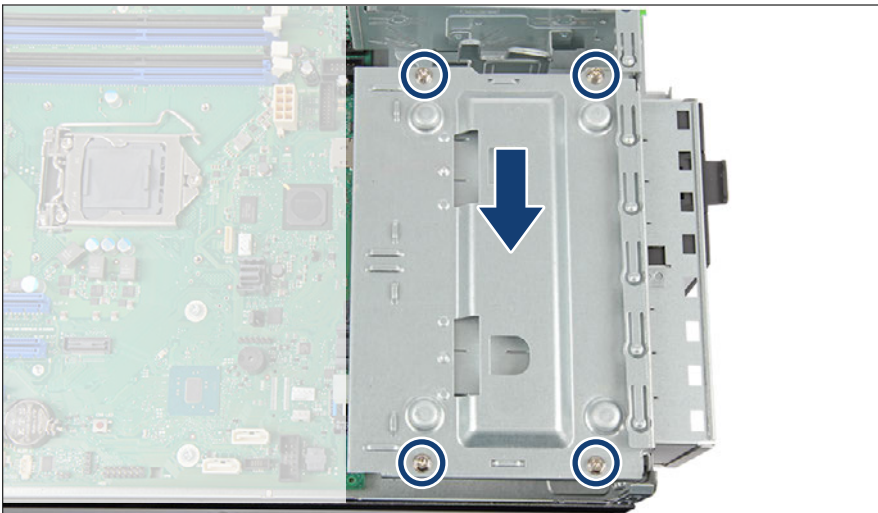

Figure 20: Installing the HDD cage (B)

- ▶ Place the cover onto the HDD cage.
- ▶ Fasten the HDD cage with four screws and tighten them in a cross diagonal pattern (see circles).

4.12 Handling the HDD fan modules

4.12.1 Removing the HDD fan module (3.5-inch HDD variant)

- ▶ Disconnect the fan cables from the system board.

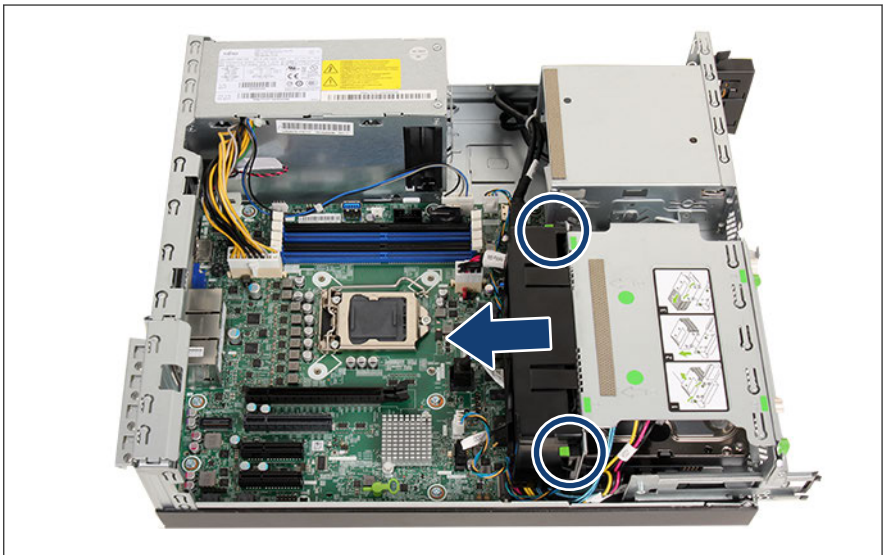

Figure 21: Removing the HDD fan module

- ▶ Press the two release latches (see circles).
- ▶ Remove the HDD fan module from the HDD cage.
- ▶ Lift up the HDD fan module.

4.12.2 Installing the HDD fan module (3.5-inch HDD variant)

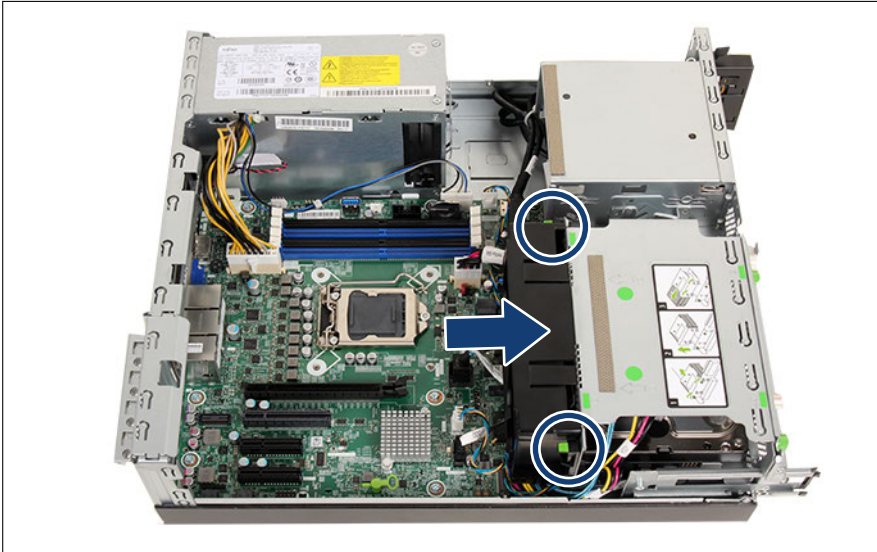

Figure 22: Installing the HDD fan module

- ▶ Install the HDD fan module onto the HDD cage until the locking latches snap in place (see circles).

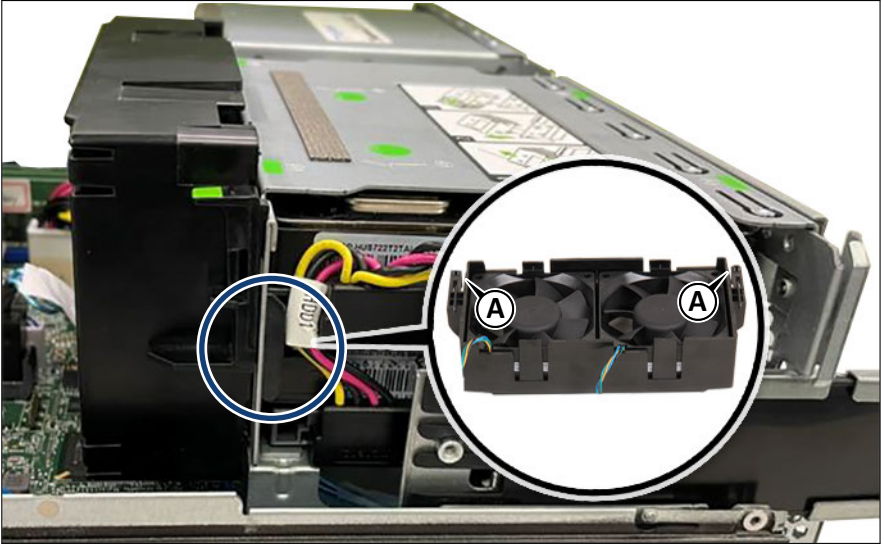
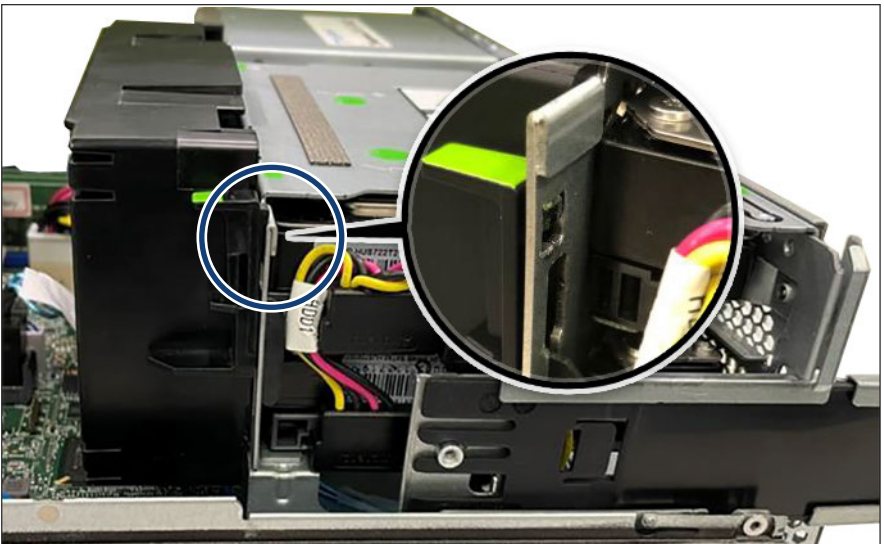

Figure 23: Hooks of the HDD fan module

- Ensure that the two hooks of the HDD fan module (see close-up, A) fit with the recesses of the HDD cage (see circle).



Basic hardware procedures

- ▶ Ensure that the two noses of the HDD fan module (see close-up) fit with the recesses of the HDD cage (see circle).
- ▶ Ensure that the fans freely rotate.
- ▶ Connect the fan cable of HDD fan module 1 to the system board connector "FAN4 SYS".
- ▶ Connect the fan cable of HDD fan module 2 to the system board connector "FAN2 SYS".

4.12.3 Removing the HDD fan module (2.5-inch HDD variant)

- ▶ Disconnect the corresponding fan cable from the system board.

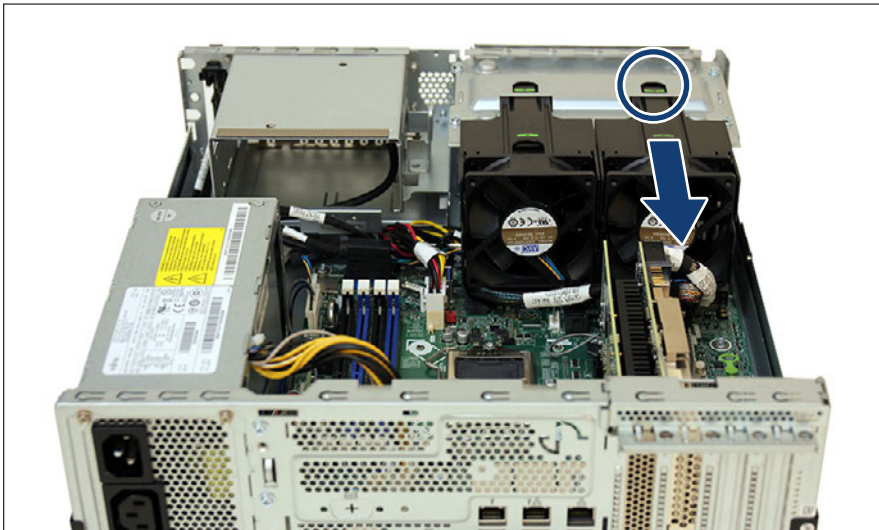

Figure 24: Removing the HDD fan module

- ▶ Press on the green tab (see circle) and remove the HDD fan module from the HDD cage.

4.12.4 Installing the HDD fan module (2.5-inch HDD variant)

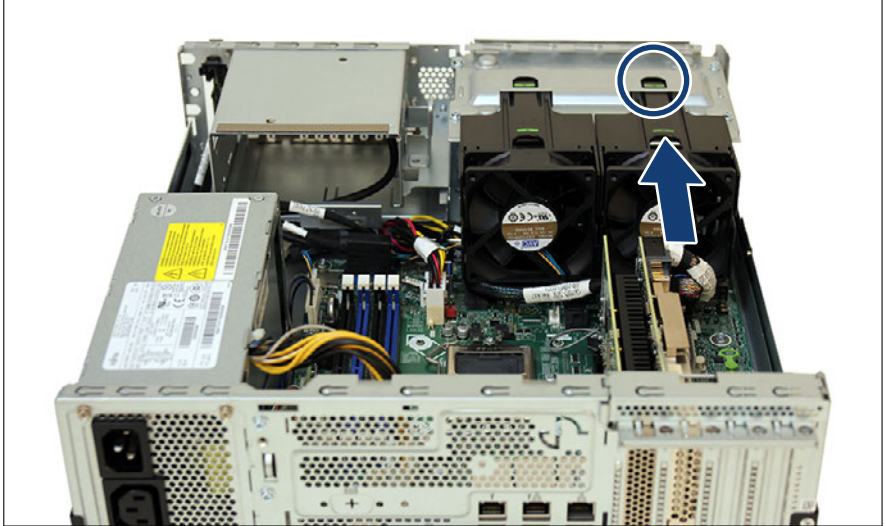

Figure 25: Installing the HDD fan module

- ▶ Install the HDD fan module onto the HDD cage until the locking latch snaps in place (see circle).
- ▶ Ensure that the fans freely rotate.
- ▶ Connect the fan cable of HDD fan module 1 to the system board connector "FAN4 SYS".
- ▶ Connect the fan cable of HDD fan module 2 to the system board connector "FAN2 SYS".

Breakout and recess in the HDD fan module

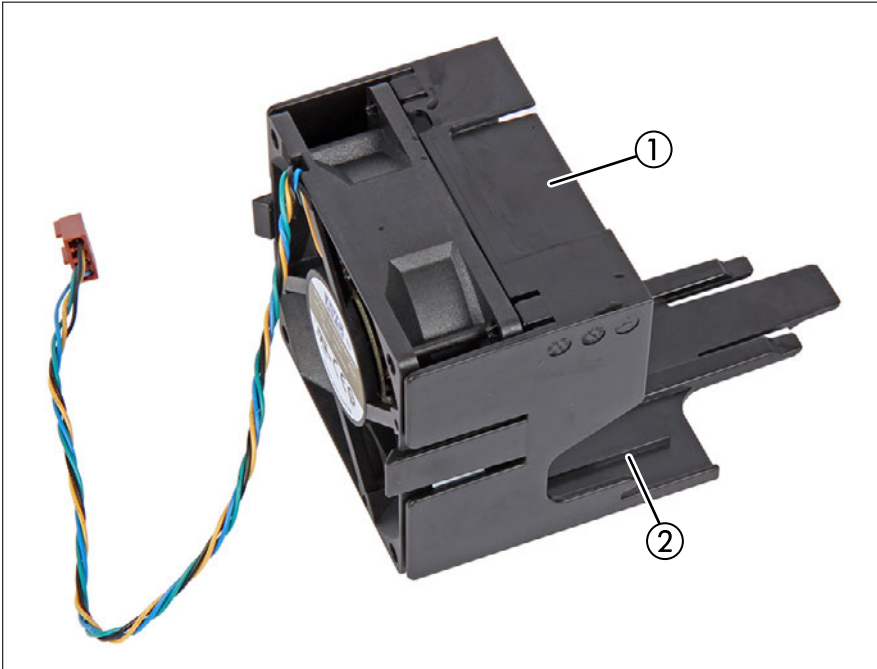

Figure 26: HDD fan module - breakout and recess

- | | | | |
|---|-------------------------------------|---|---|
| 1 | Breakout for the NVMe or SAS cables | 2 | Recess for the power/OOB cable of SAS configuration |
|---|-------------------------------------|---|---|

If using a PCIe backplane or SAS/SATA backplane:

- Break out the plastic flap of the HDD fan module by hand (1) so that the NVMe or SAS cables can be run through the breakout. This part can be disposed.

5 Basic software procedures

5.1 Validation



Depending on your server and the installed features some information is not valid for your server.

5.2 Starting the maintenance task

5.2.1 Suspending BitLocker functionality

BitLocker Drive Encryption provides protection for OS and data drives by encrypting the contents and requiring users to authenticate their credentials to access the information. In the scenario described here, BitLocker uses the compatible Trusted Platform Module (TPM) to detect if the computer's startup process has been modified from its original state.



For more information on how to use BitLocker on a computer without a compatible TPM, see the "BitLocker Drive Encryption" documentation page at:

<https://technet.microsoft.com/library/cc731549.aspx>

Suspending BitLocker Drive Encryption is a temporary method for removing BitLocker protection without decrypting the drive Windows is installed on. Suspend BitLocker before modifying the server's hardware configuration or startup files. Resume BitLocker again after the maintenance procedure is complete.



CAUTION

- With BitLocker features enabled, modifying the system configuration (hardware or firmware settings) may render the system inaccessible. The system may enter Recovery Mode and require a 48-digits recovery password to return to normal operation. Ensure that you suspend BitLocker drive encryption before maintaining the server.
 - When suspended, BitLocker uses a plain text key instead of the Trusted Platform Module (TPM) to read encrypted files. Keep in mind that information on this drive is not secure until BitLocker has been re-enabled.
- ▶ Ask the system administrator to suspend BitLocker-protection on the system volume, using the **BitLocker Drive Encryption** control panel item.
-  This will temporarily disable BitLocker for maintenance purposes. The volume will not be decrypted and no keys will be discarded.

- ▶ Click **Start - Control Panel - System and Security - BitLocker Drive Encryption** to open the BitLocker Drive Encryption.
- ▶ Select the system volume, and click **Suspend Protection**.
- ▶ Click **Yes** to confirm that your data will not be protected while BitLocker is suspended.



In order to determine which features are accessible through the BitLocker setup wizard, it may be necessary to modify the BitLocker Group Policy settings. For more information on how to suspend BitLocker drive encryption, see the Microsoft TechNet library at: <https://technet.microsoft.com/library/cc731549.aspx>

For more information, see the Fujitsu web pages.

5.2.2 Disabling the boot watchdog

The boot watchdog determines whether the OS boots within a preset time frame. If the watchdog timer expires, the system will automatically reboot.

If the system is to be started from removable boot media for firmware upgrade purposes, the boot watchdog needs to be disabled before starting maintenance

task. Otherwise, the boot watchdog might initiate a system reboot before the flash process is complete.



CAUTION

An incomplete firmware upgrade process may render the server inaccessible or result in damaged/destroyed hardware.

Timer settings can be configured in the BIOS or using the iRMC S6 web interface.

Disabling the boot watchdog in the BIOS

- ▶ Enter the BIOS.
- ▶ Select the **Server Mgmt** menu.
- ▶ Under **Boot Watchdog** set the **Action** setting to **Continue**.
- ▶ Save your changes and exit the BIOS.



For more information on BIOS settings, see the corresponding BIOS Setup Utility reference manual.

Disabling the boot watchdog using the iRMC S6 web interface

- ▶ Log in to the iRMC S6 web interface.
- ▶ Select the **Settings** menu.
- ▶ Open the **Server Management** page.
- ▶ In the **Boot Watchdog** group, check the **Enable Boot Watchdog Support** option. The **Enable Boot Watchdog Support** option must be selected.
- ▶ Select **Continue** from the **Watchdog Action** list.
- ▶ Click **Apply** for the changes to take effect.



For more information on iRMC settings, see the iRMC user guides.

5.2.3 Removing backup and optical disk media

- ▶ Ask the system administrator to eject all remaining backup or optical media from the backup drive or ODD before removing it from the server.
- ▶ If the backup media cannot be ejected by conventional means, and it is mandatory that the cartridge be removed prior to returning the drive for repair or disposing it, a manual tape extraction needs to be performed.

Please contact Fujitsu support, if "forcible" tape ejection is necessary.



Fujitsu does not assume responsibility for any damage to the tape drive, the data cartridge/tape or for the loss of any data resulting from manual tape extraction procedures.

5.2.4 Verifying and configuring the backup software solution



This task only applies to Japan.

This is a customer procedure.

Depending on the backup software solution, it may be necessary to disable or delete the backup drive from the backup software drive list before starting the maintenance task.



For more information on suitable backup software solutions and related documentation, see the Fujitsu web pages.

5.2.5 Switching on the ID indicator

For easy identification of the server, switch on the ID indicator, especially when working in a datacenter environment or a server room. The ID indicator can also be activated via the iRMC S6 web interface and its status is reported to the iRMC S6.



For more information, see ["Locating the defective server" on page 45](#) or the "ServerView Suite Local Service Concept (LSC)", the iRMC user guides or the Infrastructure Manager documentation.

Using the ID button on the front panel

- ▶ Press the ID button on the front panel to switch on the system identification LEDs.



For more information, see ["Indicators on the front panel" on page 374](#).

Using the ID icon in the iRMC S6 web interface

- ▶ Log in to the iRMC S6 web interface.

The icon that represents the ID indicator resides on the right of the menu bar. Its color symbolizes its status:

blue: the ID indicator is on.

grey: the ID indicator is off.

- ▶ Click the icon to switch the ID indicator on or off.

Using the Infrastructure Manager

- ▶ To switch on the ID indicator from the Infrastructure Manager, select a node from the **Node List** screen and operate ID indicator from the **Action** button.

5.2.6 Checking boot priority

When replacing a component that corresponds to a bootable device, check the boot priority information before and after the replacement.

- ▶ Enter the BIOS.
- ▶ Select the **Boot** menu.

The current boot order is displayed under **Boot Option Priorities**.



For more information on how to access the BIOS and modify settings, see the corresponding BIOS Setup Utility reference manual.

5.3 Completing the maintenance task

5.3.1 Updating or recovering the BIOS and iRMC S6



For Japan:
Follow the instructions provided separately.

After replacing the system board, memory or a CPU, it is essential to upgrade the BIOS and iRMC to the latest version.



When the system board is replaced, the BIOS and iRMC versions which were being used can be restored by removing the iRMC microSD card from the original system board and installing it on the replaced system board.

The latest BIOS and iRMC versions are available from the Fujitsu support internet pages at:

<https://ts.fujitsu.com/support/>

For Japan:

<https://www.fujitsu.com/jp/products/computing/servers/primergy/downloads/>



Note on the boot watchdog

Before updating or recovering the BIOS and iRMC, ensure that the boot watchdog is disabled, see "[Disabling the boot watchdog](#)" on page 74.

After updating or recovering the BIOS and iRMC, enable the boot watchdog again, see "[Enabling the boot watchdog](#)" on page 85.



Fujitsu does not assume responsibility for any damage done to the server or for the loss of any data resulting from BIOS updates.

BIOS flash procedure

- ▶ Perform the BIOS flash procedure as described in the "BIOS Setup Utility" reference manual of your server.

BIOS recovery procedure

- ▶ Perform the BIOS recovery procedure as described in the "BIOS Setup Utility" reference manual of your server.

iRMC flash procedure

- ▶ Prepare an USB stick including the bootable iRMC firmware update image.
- ▶ Connect the USB stick containing the iRMC firmware to an USB port.
- ▶ Restart the server. The system will start the POST process.
- ▶ During POST, press [F12] and select the connected USB stick as boot device. The system will detect the USB stick.
- ▶ Choose one of the following options from the update tool menu to start the iRMC update process:

Normal:

Choose this option to update an existing system board.

Initial:

Choose this option if the system board has been replaced prior to the iRMC update procedure. This option will perform all relevant flash procedures in a row, including the iRMC firmware and bootloader.



CAUTION

If the process is interrupted, the iRMC may be permanently corrupted.

- ▶ Do not interrupt the iRMC upgrade process after it has started.



If the iRMC does not work after flashing, disconnect the system from the mains and reconnect it again.

- ▶ After completion of the flash process, remove the USB stick and restart the server.

iRMC recovery procedure

- ▶ Prepare an USB stick including the bootable iRMC firmware update image.
- ▶ Ensure that the server has been shut down and disconnected from the mains, see "[Disconnecting the power cord](#)" on page 48.
- ▶ Connect the USB stick containing the iRMC firmware to an USB port.
- ▶ Connect the server to the mains while pushing the ID button on the front panel. Ask a second person to help you if necessary.

- ▶ Ensure that the Global Error indicator and the ID indicator are flashing to indicate that the server is entering the iRMC recovery state.
- ▶ Press the Power On/Off button. The system will start the POST process.
- ▶ During POST, press [F12] and select the connected USB stick as boot device. The system will detect the USB stick.
- ▶ Choose the **Recovery_L** option from the update tool menu to start the iRMC update process.



CAUTION

If the process is interrupted, the iRMC may be permanently corrupted.

- ▶ Do not interrupt the iRMC upgrade process after it has started.



If the iRMC does not work after flashing, disconnect the system from the mains and reconnect it again.

- ▶ Shut down the server by pressing the power On/Off button.
- ▶ Disconnect the server from the mains to exit the iRMC recovery state.

5.3.2 Verifying system information backup or restore

To avoid the loss of non-default settings when replacing the system board, a backup copy of important system configuration data is automatically stored from the system board NVRAM to the Chassis ID EPROM. After replacing the system board the backup data is restored from the Chassis ID board to the new system board.

In order to verify whether the backup or restore process has been successful, check the System Event Log (SEL), see "[Viewing and clearing the System Event Log \(SEL\)](#)" on page 87.



When using the Infrastructure Manager, please refer to the following manuals about backup and restore function of system information.

See manual "FUJITSU Software Infrastructure Manager V2.8.0 User's Guide", section "2.10 Backup/Restore Hardware Settings", available at: <https://ts.fujitsu.com/support/>

For Japan:

See manual "FUJITSU Software Infrastructure Manager V2.8.0 解説書", section "2.10 ハードウェア設定バックアップ／リストア機能", available at: <https://www.fujitsu.com/jp/products/software/infrastructure-software/infrastructure-software/serverviewism/technical/>

After replacing the system board

- ▶ Check the SEL log files to verify whether the backup data on the Chassis ID EPROM has been restored to the system board, see "[Viewing and clearing the System Event Log \(SEL\)](#)" on page 87.

Chassis IDPROM: Motherboard Exchange detected

Chassis IDPROM: BMC FW restore successful

Chassis IDPROM: BIOS restore successful

After replacing the front panel or Chassis ID EPROM

- ▶ Check the SEL log files to verify whether a backup copy of the system board settings has been transferred to the Chassis ID EPROM, see "[Viewing and clearing the System Event Log \(SEL\)](#)" on page 87.

Chassis IDPROM: BMC FW backup successful

5.3.3 Updating expansion card firmware



For Japan:
Follow the instructions provided separately.

After replacing the expansion card, it is essential to upgrade the firmware to the latest version without connecting any storage devices. The latest expansion card firmware version is available from the Fujitsu support web pages at:

<https://ts.fujitsu.com/support/>

For Japan:

<https://www.fujitsu.com/jp/products/computing/servers/primergy/downloads/>



Note on the boot watchdog

Before updating expansion card firmware, ensure that the boot watchdog is disabled, see ["Disabling the boot watchdog" on page 74](#).

After updating expansion card firmware, enable the boot watchdog again, see ["Enabling the boot watchdog" on page 85](#).



Fujitsu does not assume responsibility for any damage done to the server or for the loss of any data resulting from firmware updates.

Using the ServerView Update Manager

For more information on how to update the expansion card firmware using the ServerView Update Manager or Update Manager Express (UME), see the following manuals:

- ServerView Update Manager: "ServerView Update Management" user guide
- ServerView Update Manager Express: "Local System Update for PRIMERGY Servers" user guide

Using the flash tool

The latest firmware files are available as ASPs (Autonomous Support Packages) for Windows or as Linux tools from the Fujitsu support web pages at:

<https://ts.fujitsu.com/support/>

For Japan:

<https://www.fujitsu.com/jp/products/computing/servers/primergy/downloads/>

5.3.4 Reconfiguring the backup software solution



This task only applies to Japan.

This is a customer procedure.

Disabling backup drives

Depending on the backup software solution, it may be necessary to disable or delete the backup drive from the backup software drive list and reconfigure backup jobs after completing the maintenance task.



More information on suitable backup software solutions and related documentation is available from the Fujitsu web pages.

Re-enabling backup drives

If a backup drive has been disabled or deleted from the backup software drive list (see ["Verifying and configuring the backup software solution" on page 76](#)), it has to be re-enabled to complete the maintenance task.

- ▶ Re-enable backup drives and revise backup software settings and cronjobs.



More information on suitable backup software solutions and related documentation is available from the Fujitsu web pages.

5.3.5 Resetting the boot retry counter

The boot retry counter is decremented from its preset value every time the POST watchdog initiates a system reboot. When the value has reached '0', the system will shut down and power off.

Viewing the boot retry counter

The current boot retry counter status is available in the BIOS:

- ▶ Enter the BIOS.
- ▶ Select the **Server Mgmt** menu.
- ▶ Under **Boot Retry Counter** the current number of remaining boot attempts is displayed. The value is further decremented with every failed boot attempt or system reboot resulting from critical system errors.
- ▶ Exit the BIOS.

Resetting the boot retry counter

The boot retry counter should be reset to its original value concluding every service task.



Please note, if the customer does not know about the original boot retry values:

If the system boots up and no further errors occur within 6 hours after that successful boot attempt, the boot retry counter will automatically be reset to its default value. Please take into account, that the specified number of boot attempts can only be determined after this period of time.

If the customer knows about the original boot retry values, proceed as follows to reset or configure the boot retry counter:

Resetting the boot retry counter in the BIOS

- ▶ Enter the BIOS.
- ▶ Select the **Server Mgmt** menu.
- ▶ Under **Boot Retry Counter** press the [+] or [-] keys to specify the maximum number of boot attempts (0 to 7).
- ▶ Exit the BIOS.

Resetting the boot retry counter using iRMC S6 web interface

- ▶ Enter the iRMC S6 web interface.
- ▶ Select the **Server Management** menu.
- ▶ The following boot retry counter settings are available under **ASR&R Options**:
 - ▶ Under **Retry counter max** specify the maximum number of attempts to boot the OS (0 to 7).
 - ▶ Under **Retry counter** the current number of remaining boot attempts is displayed. Overwrite this value with the maximum number of boot attempts specified above in order to reset the boot retry counter.
- ▶ Click **Apply** for the changes to take effect.



For more information on iRMC settings, see the iRMC user guides.

5.3.6 Enabling the boot watchdog

If the boot watchdog has been disabled for firmware upgrade purposes (see ["Disabling the boot watchdog" on page 74](#)), it has to be re-enabled to complete the maintenance task.

Timer settings can be configured in the BIOS or using the iRMC S6 web interface.

Enabling the boot watchdog in the BIOS

- ▶ Enter the BIOS.
- ▶ Select the **Server Mgmt** menu.
- ▶ Under **Boot Watchdog** set the **Action** setting to **Reset**.
- ▶ Save your changes and exit the BIOS.



For more information on how to access the BIOS and modify settings, see the corresponding BIOS Setup Utility reference manual.

Enabling the boot watchdog using the iRMC S6 web interface

- ▶ Log in to the iRMC S6 web interface.
- ▶ Select the **Settings** menu.
- ▶ Open the **Server Management** page.
- ▶ In the **Boot Watchdog** group, check the **Enable Boot Watchdog** option. The **Enable Boot Watchdog** option must be selected.
- ▶ Select **Reset** from the **Watchdog Action** list.
- ▶ Click **Apply** for the changes to take effect.



For more information on iRMC settings, see the iRMC user guides.

5.3.7 Enabling replaced components in the BIOS

When a CPU, an expansion card, or a memory module fails, the defective component will be set to **Disabled** or **Failed** in the BIOS. The server will then reboot with only the intact hardware components remaining in the system configuration. After replacing the defective component, it needs to be reenabled in the BIOS.

- ▶ Enter the BIOS.
- ▶ Select the **Advanced** menu.
- ▶ Select the status menu of the desired component:
 - ▶ Select **CPU Status** for CPUs.



This option is only available for multi-processor systems.

- ▶ Select **Memory Status** for memory modules.
 - ▶ Select **PCI Status** for expansion cards.
- ▶ Reset replaced components to **Enable**.
- ▶ Save your changes and exit the BIOS.



For more information on how to access the BIOS and modify settings, see the corresponding BIOS Setup Utility reference manual.

5.3.8 Verifying the system time settings



This task only applies to Linux and VMware environments.

After the system board has been replaced, the system time is set automatically. By default, the RTC (Real Time Clock) time standard is set as the local time.

If a Linux/VMware OS is used and the hardware clock has been configured as UTC (Universal Time, Coordinated) in the OS, the BMC local time may not be mapped correctly.

- ▶ After replacing the system board, ask the system administrator whether the RTC or UTC time standard is to be used as system time.



If the system time (RTC) is set to UTC, the SEL (System Event Log) time stamps may differ from the local time.

- ▶ Enter the BIOS.
- ▶ Select the **Main** menu.
- ▶ Under **System Time** and **System Date** specify the correct time and date.



By default, the system time set in the BIOS is RTC (Real Time Clock) local time. If your IT infrastructure relies on universally accepted time standards, set the **System Time** to UTC (Universal Time, Coordinated) instead. Greenwich Mean Time (GMT) can be considered equivalent to UTC.

- ▶ Save your changes and exit the BIOS.



For more information on how to access the BIOS and modify settings, see the corresponding BIOS Setup Utility reference manual.

5.3.9 Viewing and clearing the System Event Log (SEL)



You can view the System Event Log (SEL) using the iRMC S6 web interface.



You can clear the System Event Log (SEL) using the iRMC S6 web interface.



You can collect logs using the Infrastructure Manager.

Viewing the SEL using the iRMC S6 web interface

- ▶ Log in to the iRMC S6 web interface.
- ▶ Open the **Logs** menu.
- ▶ Click **System Event Log** to open the System Event Log page.
All events concerning the system are displayed in a table in the Event Log Content group.
- ▶ You can sort the table based on a column using the arrows in the header field.
- ▶ You can also filter the table using the filter lists in the header of some columns.



Note on the Driver Monitor of the iRMC S6 web interface

The **Driver Monitor** view gives you an overview of the monitored components.

If a component has the status **Warning** or **Error**, you can click **Reset status**. You have to log on to the iRMC S6 web interface beforehand. The status of the component will then be reset to ok. To see the new status you must refresh the iRMC S6 web interface.



For more information on iRMC settings, see the iRMC user guides.

Clearing the SEL using the iRMC S6 web interface

- ▶ Log in to the iRMC S6 web interface.
- ▶ Open the **Logs** menu.
- ▶ Click **System Event Log** to open the System Event Log page.
All events concerning the system are displayed in a table in the Event Log Content group.
- ▶ Click the **Clear Logs** button above the table to clear the SEL.



For more information on iRMC settings, see the iRMC user guides.

Collecting logs using the Infrastructure Manager

The Infrastructure Manager can collect various logs including System Event Log for system operation and maintainance.



Please refer to the following manuals of Infrastructure Manager for collecting logs from ISM.

See manual "FUJITSU Software Infrastructure Manager V2.8.0 User's Guide", section "2.5 Log Management", available at:

<https://ts.fujitsu.com/support/>

For Japan:

See manual "FUJITSU Software Infrastructure Manager V2.8.0 解説書", section "2.5 ログ管理機能", available at:

<https://www.fujitsu.com/jp/products/software/infrastructure-software/infrastructure-software/serveviewism/technical/>

5.3.10 Updating the NIC configuration file in a Linux and VMware environment

In order to prevent errors caused by changing network device names (**eth<x>**), it is recommended to store the MAC address (hardware address) of a network interface card in the related NIC configuration file of the Linux/VMware OS. When replacing a network controller or the system board with onboard LAN controllers in a server running Linux/VMware OS, the MAC address will change but not automatically be updated in the definition file.

In order to prevent communication problems, it is necessary to update the changed MAC address stored in the related **ifcfg-eth<x>** definition file.



Procedures may differ depending on your Linux/VMware OS or the definition file on the client system. Use the following information as reference. Ask the system administrator to change the definition file.

To update the MAC address, proceed as follows:

- ▶ After replacing a network controller or the system board, switch on and boot the server, see ["Switching on the server" on page 63](#).

The hardware configuration tool for Red Hat Linux, will launch at boot and detect the new and/or changed hardware on your system.

- ▶ For the changes to take effect, you need to reboot the network by entering the following command:

```
# service network restart
```



If the system board or network controller offers multiple LAN ports, it is necessary to update the remaining **ifcfg-eth<x>** definition files accordingly.

- ▶ Update the NIC configuration file to reflect the new card sequence and MAC address.

5.3.11 Resuming BitLocker functionality

If BitLocker Drive Encryption has been suspended for maintenance purposes (see ["Suspending BitLocker functionality" on page 73](#)), it has to be reenabled to complete the service task.

- ▶ If applicable, ask the system administrator to enter the recovery key in order to boot the OS.



If BitLocker Drive Encryption has been suspended prior to replacing components you won't be asked for a recovery key when rebooting the server after the maintenance task. However, if BitLocker functionality has not been suspended, Windows will enter recovery mode and ask you to input recovery key for further booting.

- ▶ Ask the system administrator to enable the previously suspended BitLocker protection on the system volume, using the **BitLocker Drive Encryption** control panel item:
 - ▶ Click **Start - Control Panel - System and Security - BitLocker Drive Encryption** to open the BitLocker Drive Encryption.
 - ▶ Select the system volume, and click **Resume Protection**.



For more information on how to resume BitLocker drive encryption, see the Microsoft TechNet library at:

<https://technet.microsoft.com/library/cc731549.aspx>

For more information, see the Fujitsu web pages.

5.3.12 Performing a RAID array rebuild

After replacing an HDD that has been combined into a RAID array, RAID rebuild will be performed completely unattended as a background process.

- ▶ Ensure that the RAID array rebuild has started normally. Wait until the progress bar has reached at least one percent.
- ▶ Inform the customer about the remaining rebuild time, based on the displayed duration estimate.

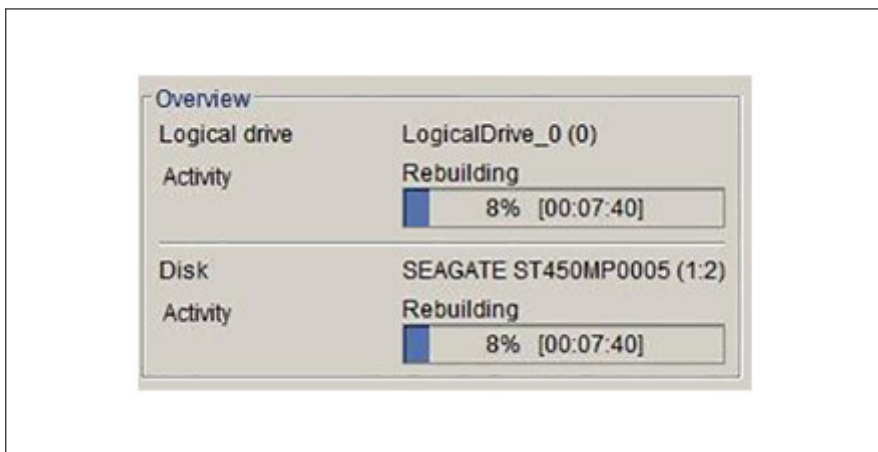

Figure 27: Progress bar (RAID array rebuild)



CAUTION

The system is now operational, however, data redundancy will not be available until the RAID array rebuild is complete. Depending on the HDD capacity the overall process can take up to several hours, in some cases even days.



You may notice a slight performance impact during rebuild.

5.3.13 Looking for MAC/WWN/GUID and SAS addresses

5.3.13.1 Basic information

The customer needs to know the new address of the controller:

- When replacing the system board with an onboard LAN controller
- When adding or replacing a network controller
- When adding or replacing a SAS controller

Different controllers send different addresses:

- LAN controller: MAC (Media Access Control) address
- Fibre channel controller: WWN (World Wide Name) address
- Infiniband/Omni-Path controller: GUID (Globally Unique Identifier) address
- SAS controller: SAS (Serial Attached SCSI) address

5.3.13.2 Looking for the MAC address of a LAN controller

There are several possible locations where these addresses can be found.

- ▶ Inform the customer about the new or changed MAC address.

Checking the label

- ▶ If available, check the label on the controller. Beside the part number, you may find the MAC address.

Using the BIOS

- ▶ Enter the BIOS setup menu.
- ▶ Select the **Advanced** menu.

The addresses are displayed at the **Advanced** menu main page.



Only network controllers supporting the Command Line Protocol (CLP) will be displayed.

LAN controller provide the MAC addresses independent on Legacy Boot or UEFI Boot.

Using the iRMC S6 web interface

- ▶ Log in to the iRMC S6 web interface.
- ▶ Open the **System** menu.
- ▶ Open the **Network** page.
- ▶ In the **Network Adapters** group, you will find detailed information on each network controller in the managed PRIMERGY server, including its MAC address.



This information is only available with the iRMC S6 or above. Only network controllers supporting the Command Line Protocol (CLP) will be displayed.



For add-in cards the vendors provide documentation and tools, offered on the Fujitsu support web pages:

<https://ts.fujitsu.com/support/>

Select the server, select **Downloads - More Details - Driver**. Some vendors bundle the documentation together with the driver package.

5.3.13.3 Looking for the WWN address of a fibre channel controller

There are several possible locations where these addresses can be found.

- ▶ Inform the customer about the new or changed WWN address.

Checking the label

- ▶ If available, check the label on the controller. Beside the part number, you may find the WWN address.

Using an UEFI BIOS

- ▶ Enter the BIOS setup menu.
- ▶ Select the **Advanced** menu.

The addresses are displayed at the **Advanced** menu main page.



Only network controllers supporting the Command Line Protocol (CLP) will be displayed.

5.3.13.4 Looking for the GUID address of an infiniband or Omni-Path controller

- ▶ If available, check the label on the controller. Beside the part number, you may find the GUID address.
- ▶ Inform the customer about the new or changed GUID address.

5.3.13.5 Looking for SAS addresses of SAS controllers for external devices

These addresses can be found using the iRMC S6 web interface.

- ▶ Log into the iRMC S6 web interface.
- ▶ Open the **System** menu.
- ▶ Open the **Mass Storage** page.
- ▶ Select the desired SAS controller.
- ▶ Expand the settings of the selected SAS controller. You can find data including the SAS address.



For more information, see the "iRMC S6 - Web Interface" user guide.

- ▶ Inform the customer about the new SAS address. The customer need the new SAS address, especially when the server is connected to a Fujitsu Storage ETERNUS system.

5.3.14 Using the Chassis ID Prom Tool

The front panel (front panel module, front panel board or front panel on QRL) contains the Chassis ID EPROM that stores the following system information:

- server name and model
- housing type
- serial number
- manufacturing data
- information depending on the configuration:
 - installed HDD/SSD backplanes
 - installed extension boxes
 - installed expansion cards (for example Retimer, EP5xxi)

In order to integrate your system into the ServerView Management environment and to enable server installation using the ServerView Installation Manager, system information needs to be completed and corrected.

System information has to be updated after one of the following tasks:

- Front panel module
 - replacing (with the same type)
 - changing (from front panel module 2.5-inch to front panel on QRL)
- HDD/SSD backplane (2.5-inch, 3.5-inch, PCIe)
 - installing
 - removing
 - changing (the technology, for example from SAS/SATA to PCIe)

Basic software procedures

- Extension boxes
 - installing
 - removing
- Specified expansion cards (for example Retimer, EP5xxi)
 - replacing
- Converting the server
 - from rack model to floorstand model
 - from floorstand model to rack model

Update your system information using the Chassis ID Prom tool. The tool and more information are available to maintenance personnel from the Fujitsu web pages:

<https://partners.ts.fujitsu.com/com/service/ps/Servers/PRIMERGY/>

- ▶ Select your PRIMERGY system from the main area of the page.
- ▶ From the categories selection, choose **Software & Tools Documentation**.
- ▶ In the **Tools** area click **Tools: Chassis-IDProm Tool** to download the file (*tool-chassis-Idprom-Tool.zip*).



For Japan:
Follow the instructions provided separately.

Note on dust cover option

If the dust cover kit is installed, set the information within the Chassis ID Prom tool accordingly.

Note on Advanced Thermal Design (ATD)



If the Advanced Thermal Design (ATD) option is available and has been enabled for your server, please set information within the Chassis ID Prom Tool accordingly.

The ATD option can only be ordered from the manufacturer as a factory preset. To find out if your server is ATD-enabled, check for the ATD logo on the identification rating plate.

For ATD logo and more information on Advanced Thermal Design (ATD), see the operating manual of your server.



CAUTION

You can only set the ATD flag. Resetting the ATD flag using the Chassis ID Prom Tool is not possible!

5.3.15 Configuring LAN teaming

Using Infrastructure Manager

When using Infrastructure Manager and replacing LAN controller or system board, you have to deapply the profile before replacing and apply the profile again after replacing.



Please refer to the following manuals of the Infrastructure Manager.

See manual "FUJITSU Software Infrastructure Manager V2.8.0 User's Guide", section "2.4.2 Profiles and Policies", available at:

<https://ts.fujitsu.com/support/>

For Japan:

See manual "FUJITSU Software Infrastructure Manager V2.8.0 解説書", section "2.4.2 プロファイルとポリシー", available at:

<https://www.fujitsu.com/jp/products/software/infrastructure-software/infrastructure-software/serveviewism/technical/>

After replacing or upgrading LAN controllers

You need to restore the configuration for the LAN Teaming, using the LAN driver utility or OS teaming software.

- ▶ Ensure that the controllers have been assigned as primary or secondary according to your requirements.



For more information, see the relevant LAN driver manual.

After replacing a system board



The following procedure must be done for each system board that is replaced.

- ▶ Confirm with the customer whether the onboard LAN controller you have replaced has been used as part of a LAN teaming configuration.
- ▶ If LAN teaming has been active, you will need to restore the configuration using the LAN driver utility or OS teaming software.



For more information, see the relevant LAN driver manual.

5.3.16 Switching off the ID indicator

- ▶ Press the ID button on the front panel, or use the iRMC S6 web interface or the Infrastructure Manager to switch off the ID indicator after the maintenance task has been concluded successfully.



For more information, see ["Locating the defective server" on page 45](#) or the "ServerView Suite Local Service Concept (LSC)", the iRMC user guides or the Infrastructure Manager documentation.

Using the ID button on the front panel

- ▶ Press the ID button on the front panel to switch off the ID indicators.

Using the ID icon in the iRMC S6 web interface

- ▶ Log in to the iRMC S6 web interface.
The icon that represents the ID indicator resides on the right of the menu bar. Its color symbolizes its status:
 - blue:** the ID indicator is on.
 - grey:** the ID indicator is off.
- ▶ Click the icon to switch the ID indicator on or off.

Using the Infrastructure Manager

- ▶ To switch off the ID indicator from the Infrastructure Manager, select a node from the **Node List** screen and operate the ID indicator from the **Action** button.

5.3.17 Performing a fan test



Notes on replacing a defective fan

After replacing a defective system fan or PSU containing a defective fan, the fan error indicators will stay lit until the next fan test. By default, a fan test is automatically started every 24 hours. The first automatic fan test being performed after replacing a fan will turn off the fan error indicator.

If you want to start the fan test manually, you can do so by following the description below:

Executing the fan test via the iRMC S6 web interface

- ▶ Log into the iRMC S6 web interface.
The **System** menu is displayed on default.
- ▶ Open the **Cooling** page.
- ▶ Expand the **Cooling Devices** group.
- ▶ Click **Start Fan Test**.



For more information on iRMC settings, see the iRMC user guides.

5.3.18 Setting boot priority

If the boot priority has been changed after replacing a component that corresponds to a bootable device, set it to the same priority as before the replacement. To check the boot priority, see ["Checking boot priority" on page 77](#).

- ▶ Enter the BIOS.
- ▶ Select the **Boot** menu.
- ▶ If applicable, change the boot priority under **Boot Option Priorities**:
 - ▶ Press the cursor keys [↑] or [↓] to select the device for which you want to change the boot order.
 - ▶ Press the [+] key to increase the priority and the [-] key to decrease the priority for the selected device.



For more information on how to access the BIOS and modify settings, see the corresponding BIOS Setup Utility reference manual.

6 Power supply unit (PSU)

6.1 Safety notes



CAUTION

- ▶ Do not disassemble the PSU. Doing so may cause electric shock.
- ▶ Areas around the PSU may remain extremely hot after shutdown. After shutting down the server, wait for hot components to cool down before removing the PSU.
- ▶ When installing a PSU, ensure that the connector of the PSU is not damaged or bent.
- ▶ The PSU is heavy, so handle it carefully. If you drop it by mistake, injuries may result.
- ▶ For more information, see ["Important information" on page 31](#).

6.2 Basic information

The server can be equipped with:

- a standard PSU

The PSU adjusts automatically to any mains voltage in the range of 100 V -240 V.

- up to two hot-plug PSUs

In its basic configuration, the server has one PSU that adjusts automatically to any mains voltage in the range of 100 V - 240 V. Besides the PSU, a second PSU can be installed optionally to serve as a redundant power supply. If one PSU fails, the second PSU in the redundant configuration ensures operation can continue uninterrupted and the defective PSU can be replaced during operation (hot-plug). The second PSU can be installed during operation.

Power supply unit (PSU)



CAUTION

The server automatically adjusts to a mains voltage in the range from 100 V - 240 V.

- ▶ You may only operate the server if its rated voltage range corresponds to the local mains voltage.

PSU configuration (hot-plug PSUs)



Figure 28: PSU bays

Assembly rules

- Always install a dummy cover into an unused PSU bay to comply with applicable EMC regulations and satisfy cooling requirements.
- For a redundant power supply configuration you need always two PSUs with the same power class.

6.3 Standard power supply

6.3.1 Replacing the standard PSU



Field Replaceable Unit
(FRU)



Hardware: 15 minutes

Tools: Phillips PH2 / (+) No. 2 screw driver

Preliminary steps



You are advised to perform this routine with the server in a horizontal position.

- ▶ ["Locating the defective server" on page 45.](#)
- ▶ ["Suspending BitLocker functionality" on page 73.](#)
- ▶ ["Shutting down the server" on page 47.](#)
- ▶ ["Disconnecting the power cord" on page 48.](#)
- ▶ ["Getting access to the component" on page 50.](#)

Removing the defective standard PSU

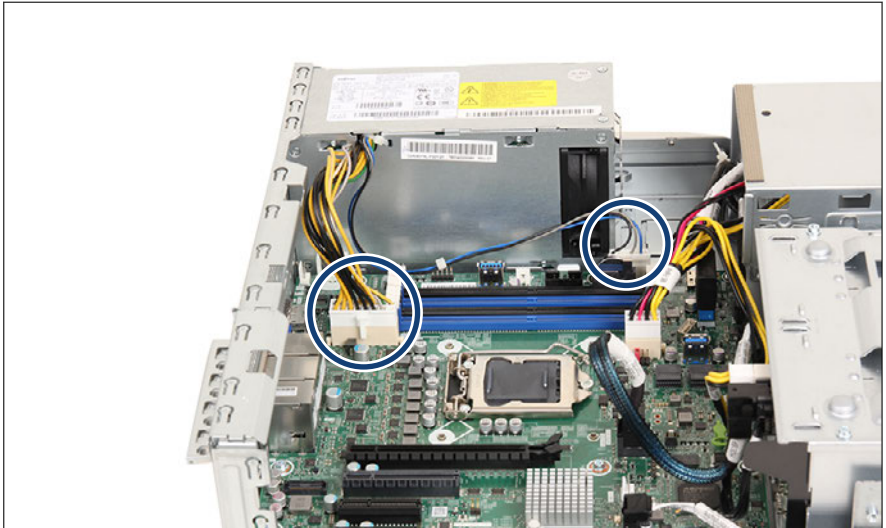

Figure 29: Disconnecting the power cables

- ▶ Disconnect the two power cables from the system board connectors "PWR1" and "PC98" (see circles).

Power supply unit (PSU)

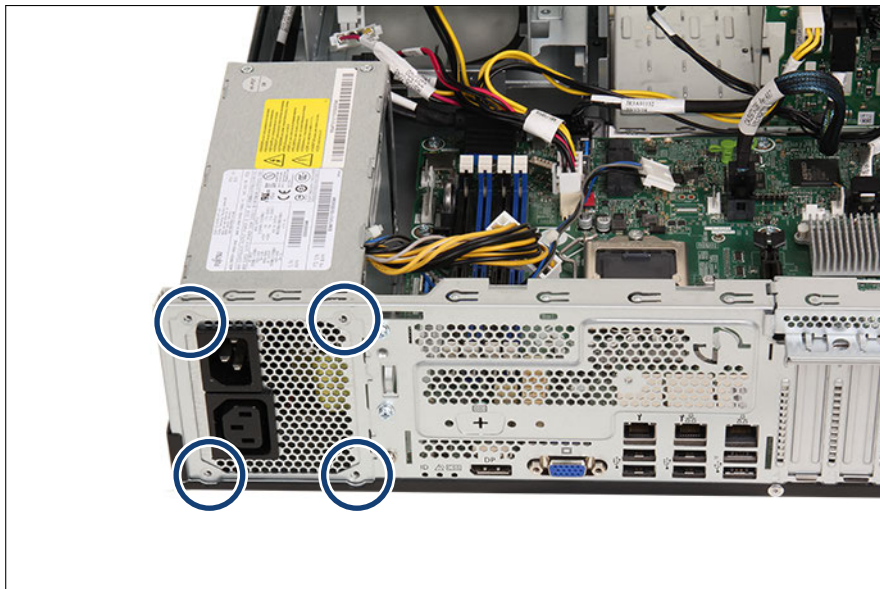

Figure 30: Removing the screws

- ▶ Remove the four screws (see circles).
- ▶ Remove the PSU plate from the outside of the chassis.

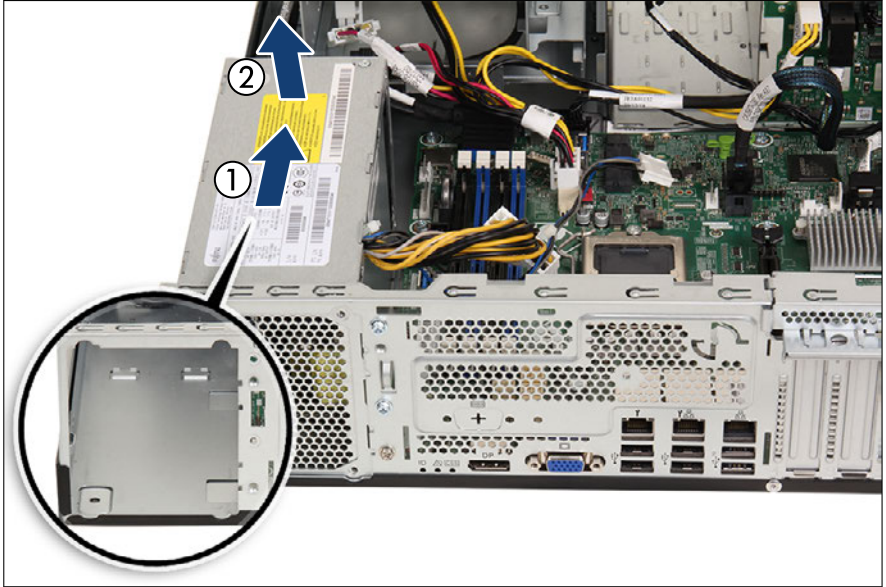

Figure 31: Removing the PSU

- ▶ Push the standard PSU a few centimeters toward the inside (1) to remove the standard PSU from the hooks (see close-up).
- ▶ Take the standard PSU out upward (2).

Power supply unit (PSU)

Installing the new standard PSU



Figure 32: Hooks on the bottom of the chassis

- Take note of the two hooks (see circles).

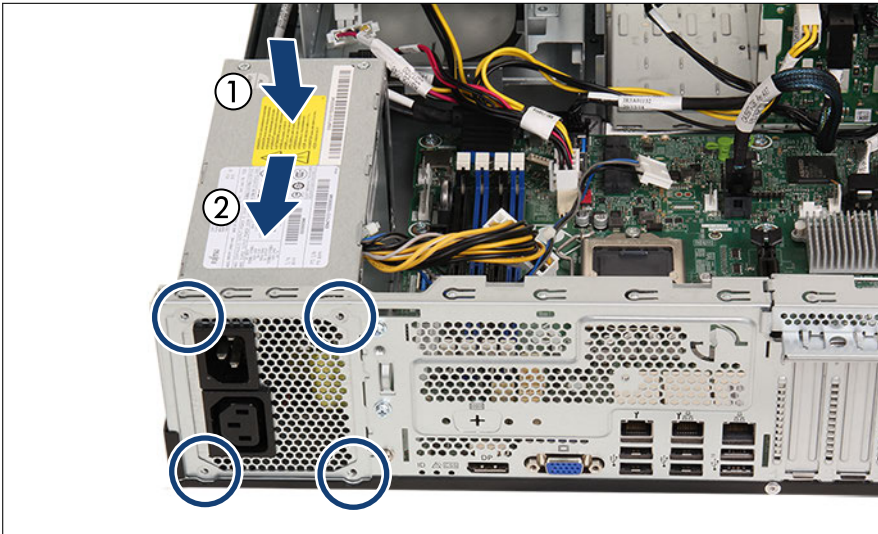

Figure 33: Installing the standard PSU

- ▶ Install the standard PSU (1).
- ▶ Ensure that the hooks on the chassis (see circles in [Figure 32](#)) engage with the notches on the lower surface of the standard PSU.
- ▶ Push the standard PSU towards the rear of the chassis (2).
- ▶ Fasten the standard PSU to the chassis with four screws (see circles).

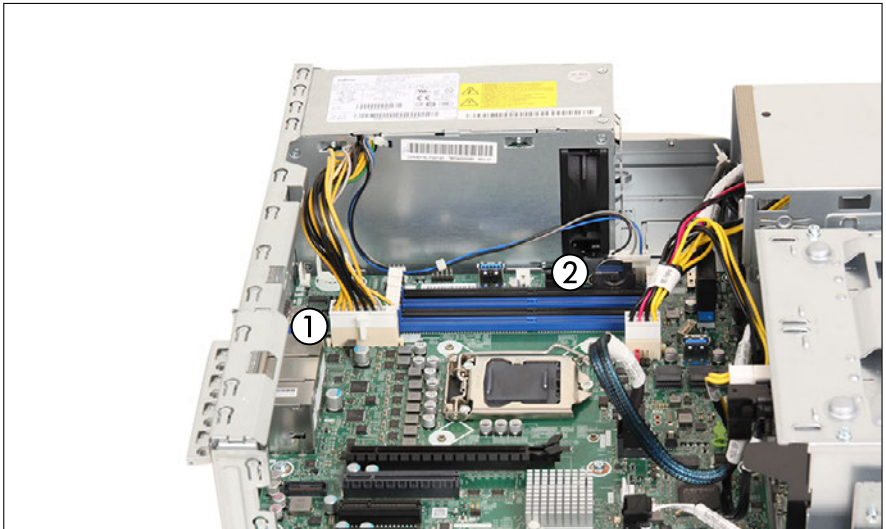

Figure 34: Connecting the power cables

- ▶ Connect the power cables to the system board:
 - 1 PSU power cable to connector "PWR1"
 - 2 Power signal cable to connector "PC98"



For the cable plan, see ["Appendix B" on page 391](#).

Concluding steps

- ▶ ["Reassembling" on page 56](#).
- ▶ ["Connecting the power cord" on page 59](#).
- ▶ ["Switching on the server" on page 63](#).

Power supply unit (PSU)

- ▶ ["Resuming BitLocker functionality" on page 90.](#)
- ▶ ["Performing a fan test" on page 99.](#)

6.3.2 Converting a standard power supply to a redundant power supply



Field Replaceable Unit (FRU)



Hardware: 15 minutes

Tools: Phillips PH2 / (+) No. 2 screw driver

The standard power supply can be replaced by a redundant power supply. The redundant power supply consists of up to two PSUs. The upgrade kit excludes the PSU, the PSUs must be additionally ordered.

The upgrade kit for the redundant power supply consists of the following parts:

- PSU cage with power distribution board (incl. power cables)
- several screws

Preliminary steps

- ▶ ["Suspending BitLocker functionality" on page 73.](#)
- ▶ ["Shutting down the server" on page 47.](#)
- ▶ ["Disconnecting the power cord" on page 48.](#)
- ▶ ["Getting access to the component" on page 50.](#)
- ▶ Remove the HDD fan modules, see ["Removing the HDD fan module \(2.5-inch HDD variant\)" on page 70](#) or ["Removing the HDD fan module \(3.5-inch HDD variant\)" on page 67.](#)
- ▶ ["Removing the 2.5-inch HDD cage" on page 63](#) or ["Removing 3.5-inch non hot-plug HDDs" on page 145.](#)
- ▶ ["Removing the expansion card" on page 211.](#)
- ▶ ["Removing the defective system board" on page 353.](#)

Removing the standard PSU

- ▶ Remove the standard PSU, see ["Removing the defective standard PSU" on page 103](#).

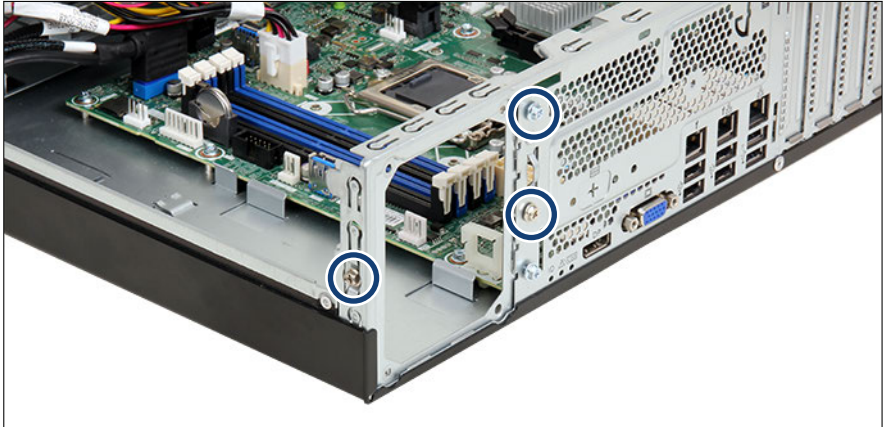

Figure 35: Removing the standard PSU frame

- ▶ Remove the three screws (see circles).

Power supply unit (PSU)

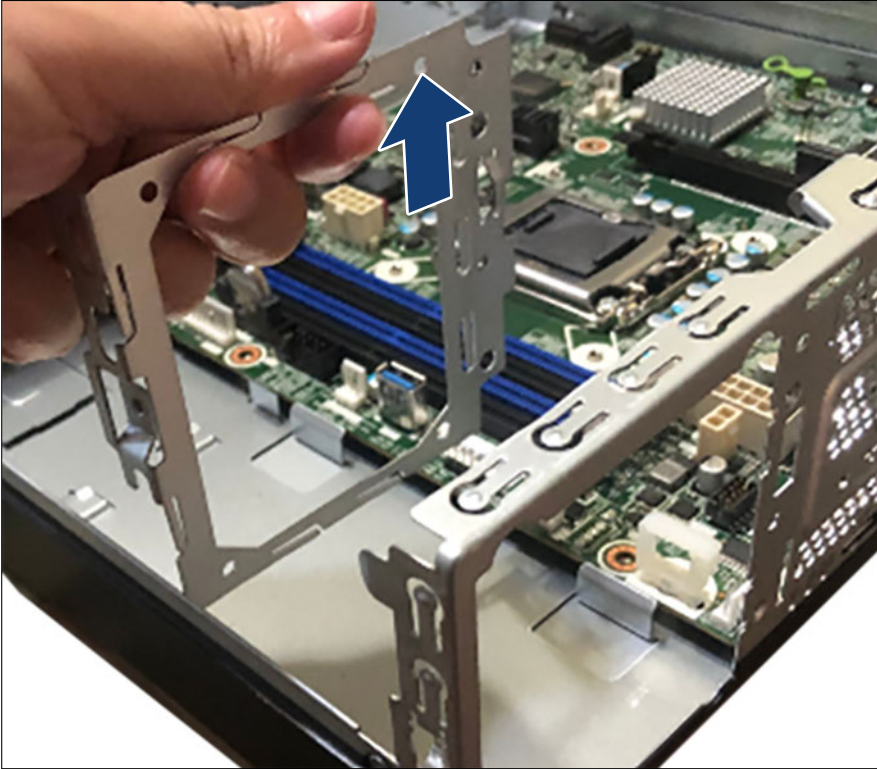

Figure 36: Removing the standard PSU frame

- ▶ Remove the standard PSU frame.

Installing the PSU upgrade kit

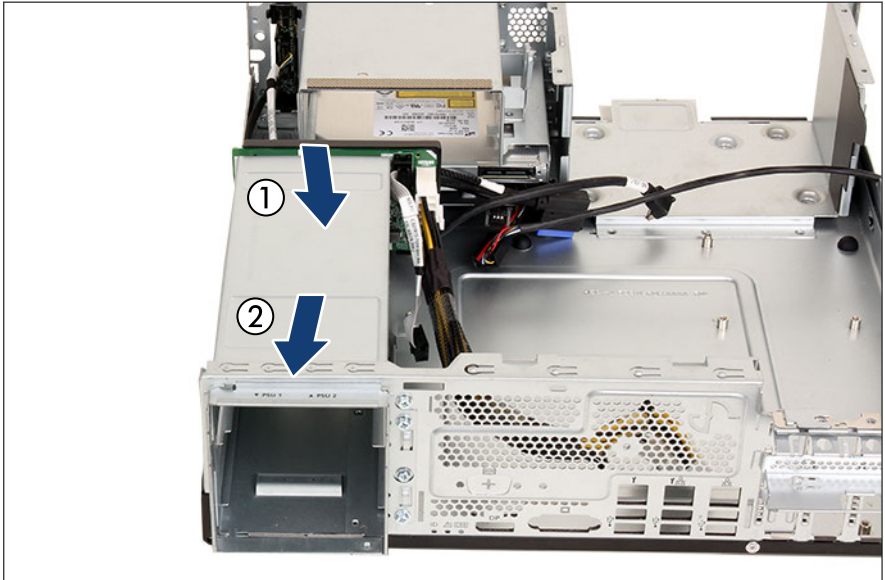

Figure 37: Installing the PSU cage (A)

- ▶ Take note of the two hooks, see circles in [Figure 32](#).
- ▶ Insert the PSU cage into the chassis (1).
- ▶ Ensure that the hooks on the chassis engage with the notches on the lower surface of the PSU cage.
- ▶ Slide the new PSU cage towards the rear of the chassis (2).

Power supply unit (PSU)

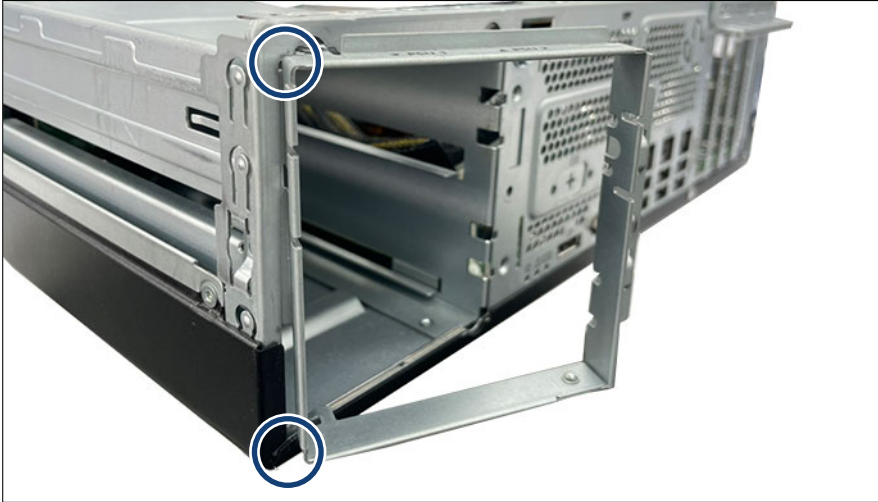

Figure 38: Installing the redundant PSU frame

- ▶ Install the redundant PSU frame at a slight angle .
- ▶ Ensure that the hooks engage in the recesses (see circles).



Figure 39: Fastening the redundant PSU frame

- ▶ Fasten the redundant PSU frame with the four screws (see circles).
- ▶ Install the power distribution board, see ["Installing the new power distribution board" on page 127](#).

Connecting the power distribution board

- ▶ Connect the cables to the power distribution board, see [Figure 56](#).

Power supply unit (PSU)

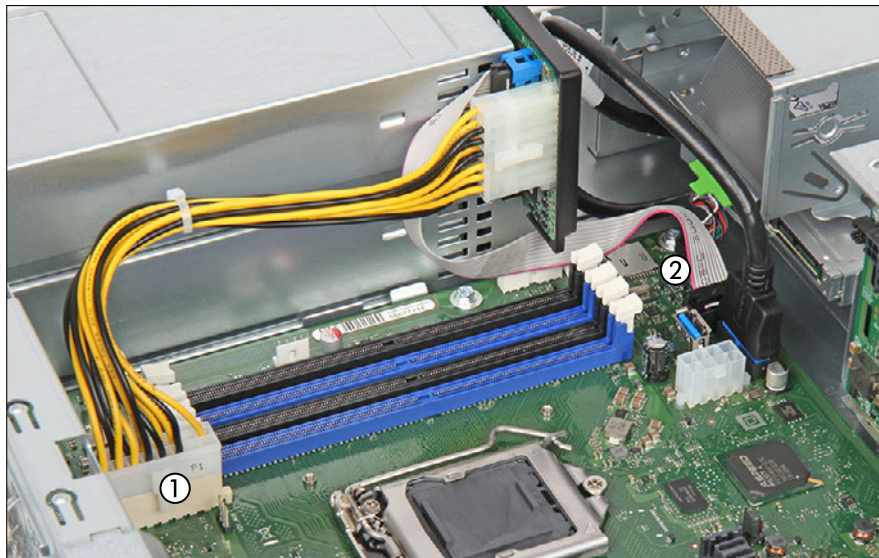

Figure 40: Connecting cables

- ▶ Connect the cables to the system board:
 - 1 PSU power cable to connector "PWR1"
 - 2 PSU signal cable to connector "P30"



For the cable plan, see ["Appendix B" on page 391](#).

Installing a hot-plug PSU and a PSU dummy cover

- ▶ Install the hot-plug PSU(s), see ["Installing the PSU" on page 118](#).



The PSU must be installed in the first bay. The dummy cover must be installed in the second bay.

- ▶ Install the dummy cover, see ["Installing the PSU dummy cover" on page 121](#).

Concluding steps

- ▶ "Installing the new system board" on page 356.
- ▶ "Installing the expansion card" on page 201.
- ▶ "Installing the 2.5-inch HDD cage" on page 65 or "Installing 3.5-inch non hot-plug HDDs" on page 140.
- ▶ Install the HDD fan modules, see "Installing the HDD fan module (2.5-inch HDD variant)" on page 71 or "Installing the HDD fan module (3.5-inch HDD variant)" on page 68.
- ▶ "Reassembling" on page 56.
- ▶ "Connecting the power cord" on page 59.
- ▶ "Switching on the server" on page 63.
- ▶ "Resuming BitLocker functionality" on page 90.

6.4 Redundant power supply

6.4.1 Installing a hot-plug PSU



Customer Replaceable Unit (CRU)



Hardware: 5 minutes

Tools: tool-less

Preliminary steps

No steps needed.

Removing the PSU dummy cover



Figure 41: Removing the PSU dummy cover

- ▶ Press in on both release latches (1) and remove the dummy cover (2).



CAUTION

- ▶ Keep the dummy cover for future use.
- ▶ If you remove a PSU and do not immediately replace it with a new one, a dummy cover must be installed in the bay again to comply with applicable EMC regulations and satisfy cooling requirements.

Installing a hot-plug PSU



Figure 42: Folding up the handle

- Push the handle of the PSU halfway upward in the direction of the arrow.

Power supply unit (PSU)

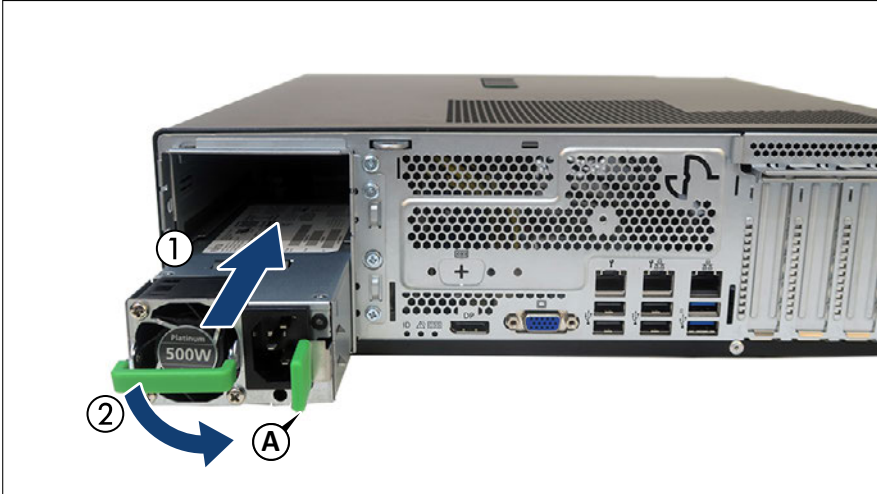

Figure 43: Installing the PSU

- ▶ Push the hot-plug PSU into its bay until the locking latch (A) snaps in place (1).
- ▶ Fold down the handle on the PSU (2).



Ensure that the PSU engages correctly in the bay and is locked in position. This is the only way to prevent the PSU from sliding out of its bay and being damaged during transportation.



Figure 44: Installing the cable clamp

- ▶ Push the cable clamp into the corresponding hole until it clicks in.

Concluding steps

- ▶ ["Connecting the power cord" on page 59.](#)
- ▶ ["Performing a fan test" on page 99.](#)

6.4.2 Removing a hot-plug PSU



**Customer Replaceable
Unit (CRU)**



Hardware: 5 minutes

Tools: tool-less

Preliminary steps

- ▶ Only when replacing a PSU in a non-redundant configuration, see ["Shutting down the server" on page 47.](#)

Power supply unit (PSU)

Removing a hot-plug PSU

- ▶ Remove the power cord from the dedicated PSU, see ["Disconnecting the power cord"](#) on page 48.

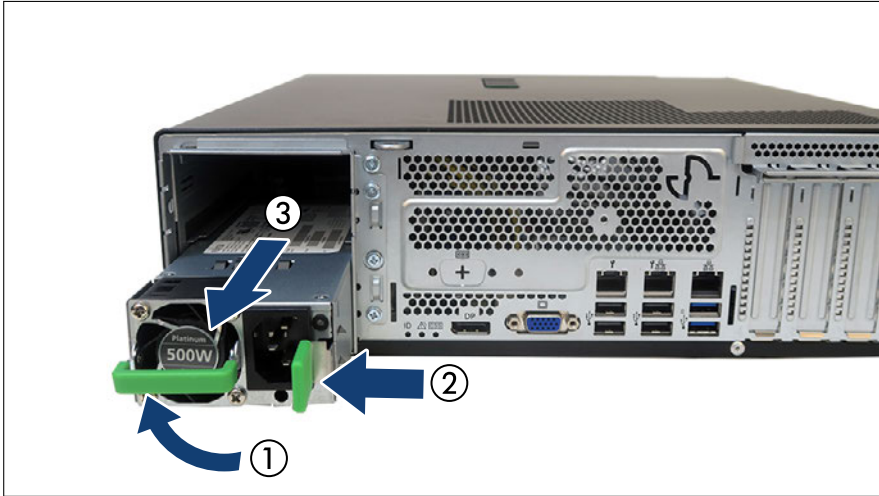

Figure 45: Removing the PSU

- ▶ Push the handle of the PSU halfway upward in the direction of the arrow (1).
- ▶ Press in on the green locking latch (2).
- ▶ While keeping the green locking latch pressed, pull the PSU out of its bay (3).



CAUTION

Excessive temperatures could damage system components.

- ▶ Never leave the bay for the hot-plug PSU empty for more than two minutes during operation.

Installing the PSU dummy cover

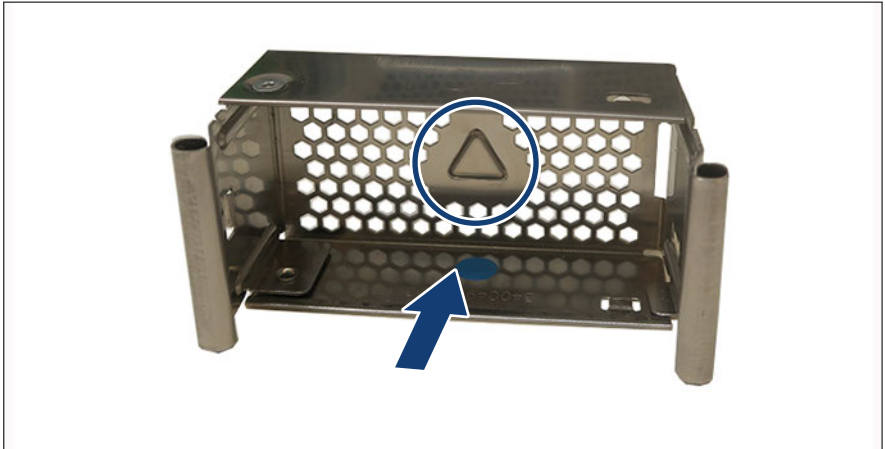

Figure 46: Installing the PSU dummy cover

- ▶ Insert the dummy cover into the empty bay with the impressed arrow symbol facing to the left (see circle).
- ▶ Push the dummy cover into its bay until it locks in place.



CAUTION

- ▶ Always install dummy covers into unused bays to comply with applicable EMC regulations and satisfy cooling requirements.

Concluding steps

No steps needed.

6.4.3 Replacing a hot-plug PSU



Customer Replaceable Unit (CRU)



Hardware: 5 minutes

Tools: tool-less



CAUTION

- ▶ When replacing a PSU in a non-redundant PSU configuration, the server must be switched off first.
- ▶ Replace the PSU after specifying the one that breaks down at work by revitalization.

Preliminary steps

- ▶ ["Locating the defective server" on page 45.](#)
- ▶ Check which PSU is defective.
A PSU is defective when the PSU status indicator lights orange. For more information, see ["Indicator on hot-plug PSU" on page 385.](#)
- ▶ Only when replacing a hot-plug PSU in a non-redundant configuration: ["Shutting down the server" on page 47.](#)
- ▶ Remove the power cord from the defective hot-plug PSU, see ["Disconnecting the power cord" on page 48.](#)

Removing the defective hot-plug PSU

- ▶ Remove the hot-plug PSU, see ["Removing a hot-plug PSU" on page 119.](#)

Installing the new hot-plug PSU

- ▶ Install the hot-plug PSU, see ["Installing a hot-plug PSU" on page 115.](#)

Concluding steps

- ▶ Connect the power cord to the new hot-plug PSU and secure it with a cable tie, see ["Connecting the power cord" on page 59.](#)
- ▶ Only when replacing a hot-plug PSU in a non-redundant configuration: ["Switching on the server" on page 63.](#)
- ▶ ["Performing a fan test" on page 99.](#)

6.4.4 Replacing the power distribution board



**Field Replaceable Unit
(FRU)**



Hardware: 25 minutes

Tools: Phillips PH2 / (+) No. 2 screw driver

Preliminary steps

- ▶ ["Locating the defective server" on page 45.](#)
- ▶ ["Suspending BitLocker functionality" on page 73.](#)
- ▶ ["Shutting down the server" on page 47.](#)
- ▶ ["Disconnecting the power cord" on page 48.](#)
- ▶ ["Getting access to the component" on page 50.](#)
- ▶ If applicable, remove the ODD, see ["Removing the ODD" on page 262.](#)
- ▶ If applicable, remove the RDX drive, see ["Removing the RDX drive" on page 271.](#)

Removing the defective power distribution board

- ▶ Remove all PSUs, see ["Removing a hot-plug PSU" on page 119.](#)

Power supply unit (PSU)

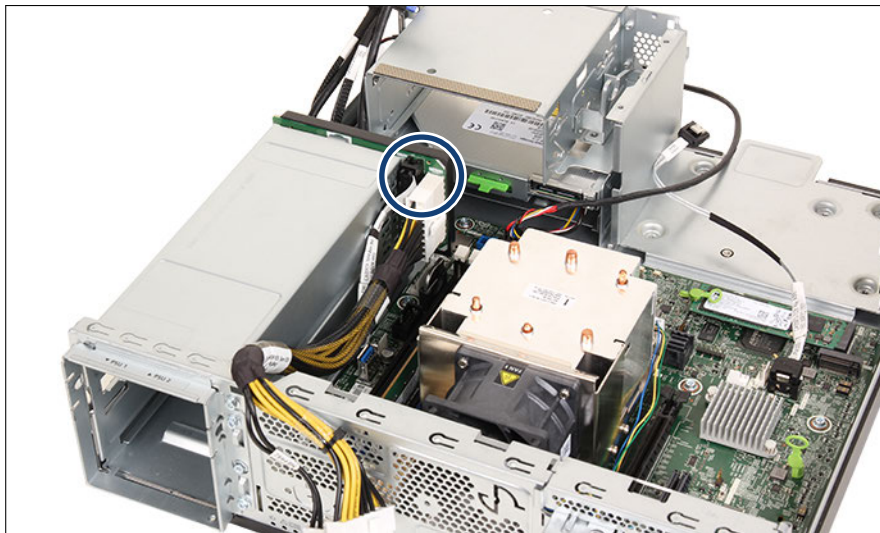

Figure 47: Disconnecting cables from the power distribution board

- ▶ Disconnect all cables from the power distribution board (see circle).

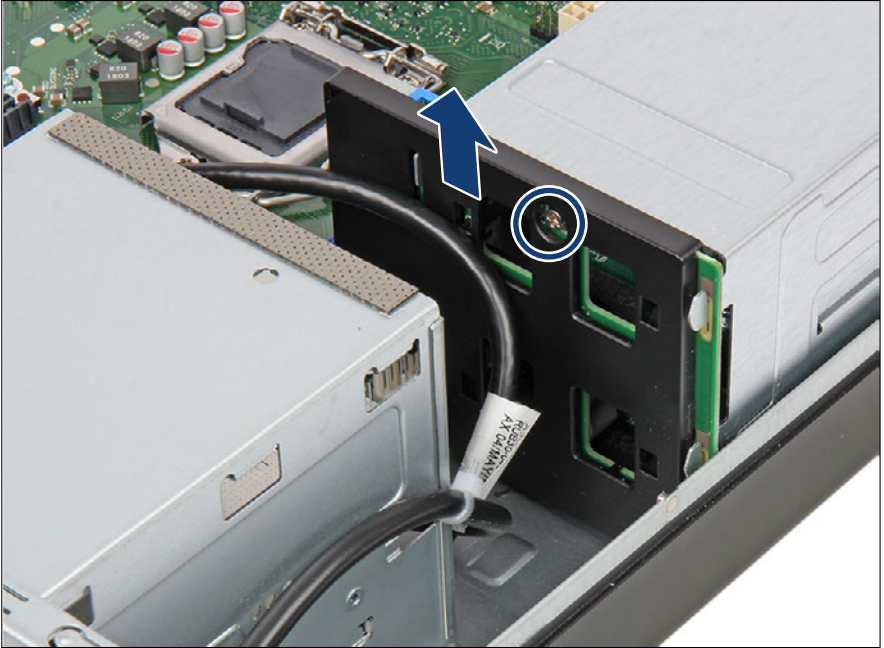

Figure 48: Removing the power distribution board (A)

Power supply unit (PSU)

- ▶ Remove the screw (see circle).



For easier access to the screw of the power distribution board, it could be helpful to remove the accessible drives, see ["Removing the ODD" on page 262](#) and ["Removing the RDX drive" on page 271](#).



Figure 49: Access to the screw of the power distribution board

- ▶ Remove the power distribution board upwards.

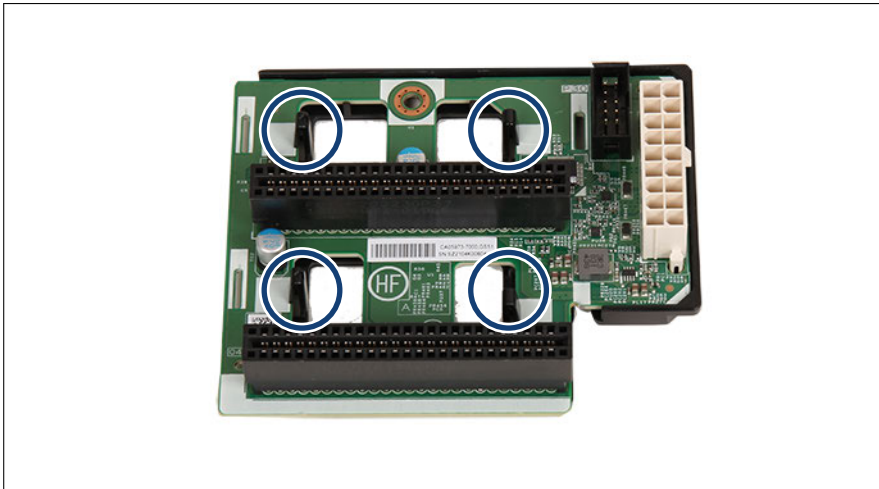

Figure 50: Removing the power distribution board (A)

- ▶ Remove the power distribution board from the four hooks of the holder (see circles).

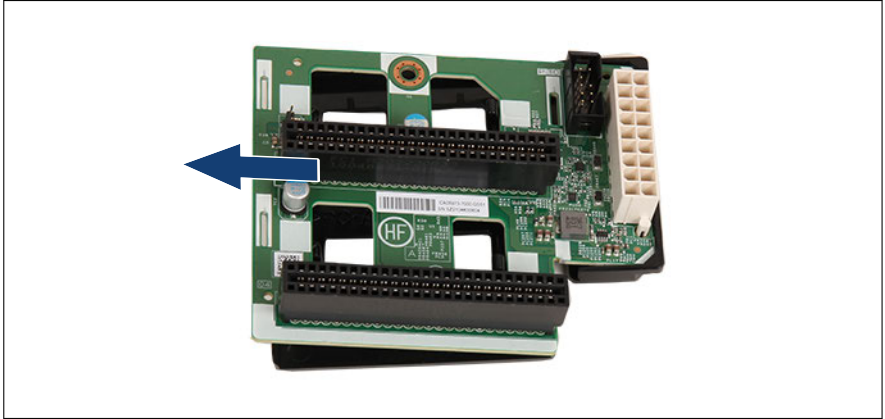

Figure 51: Removing the power distribution board (B)

- ▶ Remove the power distribution board from the holder.

Installing the new power distribution board

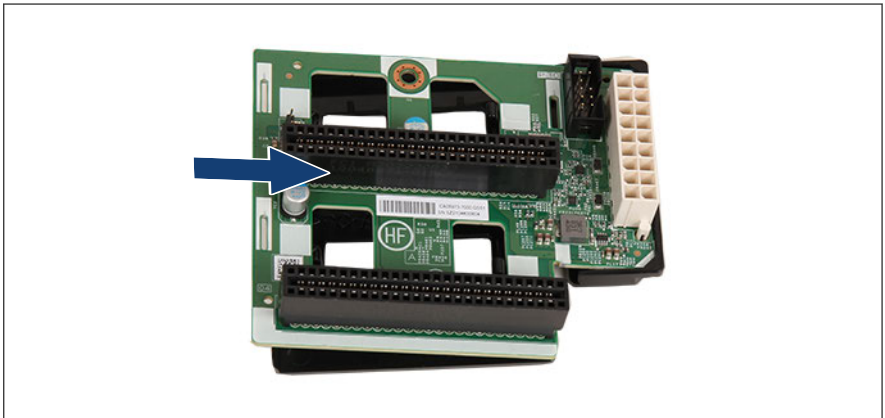

Figure 52: Inserting the power distribution board (A)

- ▶ Insert the power distribution board at a slight angle into the holder.

Power supply unit (PSU)

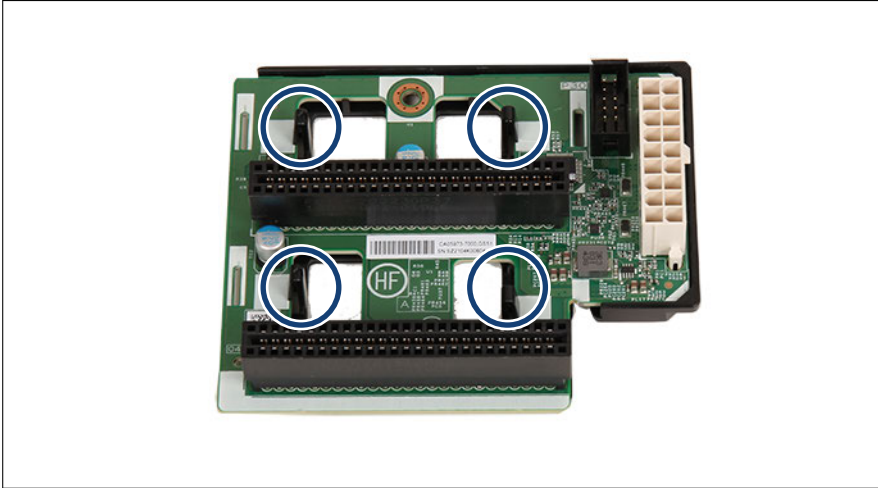

Figure 53: Inserting the power distribution board (B)

- ▶ Place the power distribution board on the four hooks of the holder (see circles) and push it down.

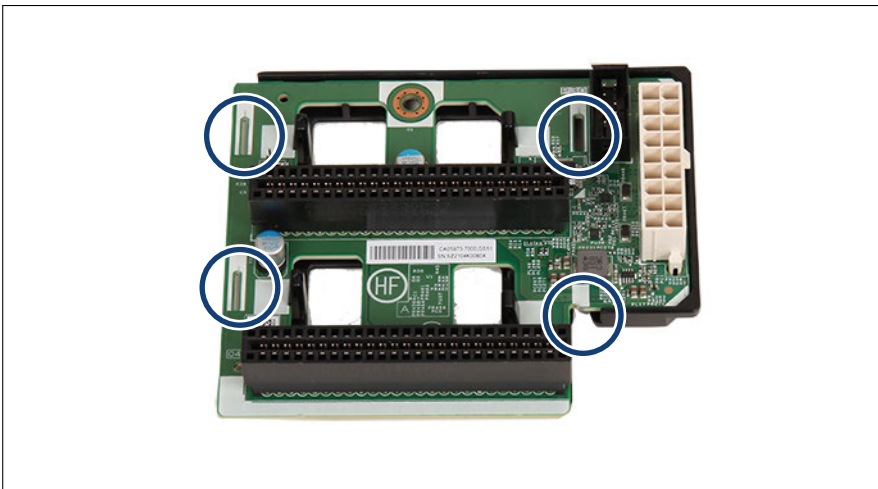

Figure 54: Recesses on the power distribution board

- ▶ Take note of the four recesses on the power distribution board (see circles).



Figure 55: Installing the power distribution board

- ▶ Hook the power distribution board in the hooks at both sides of the PSU cage.
- ▶ Fasten the power distribution board through the empty drive bay with one screw (see circle).

Power supply unit (PSU)

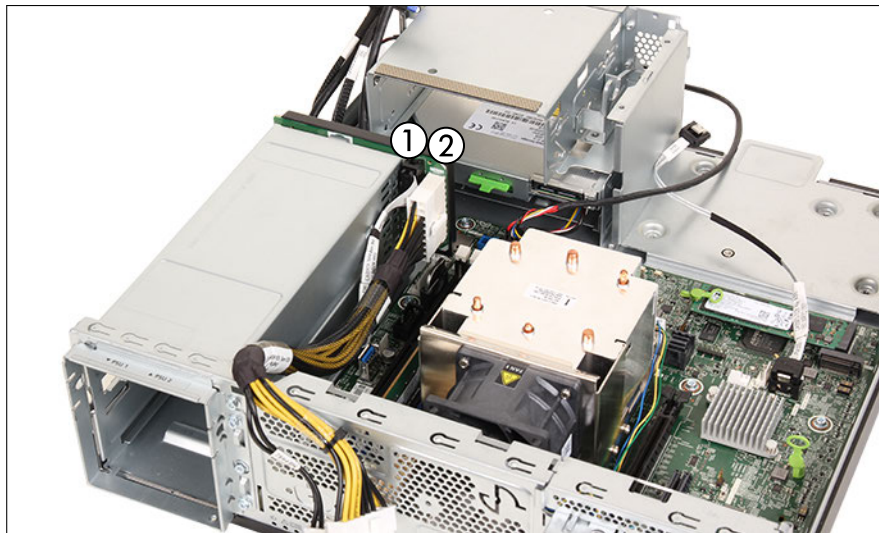

Figure 56: Connecting the power distribution board

► Connect the cables to the power distribution board:

- 1 PSU signal cable
- 2 PSU power cable



For the cable plan, see ["Appendix B" on page 391](#).

► Install the PSUs, see ["Installing a hot-plug PSU" on page 115](#).

Concluding steps

- If applicable, install the RDX drive, see ["Installing the RDX drive" on page 267](#).
- If applicable, install the ODD, see ["Installing the ODD" on page 256](#).
- ["Reassembling" on page 56](#).
- ["Connecting the power cord" on page 59](#).
- ["Switching on the server" on page 63](#).
- ["Resuming BitLocker functionality" on page 90](#).

6.5 Fujitsu battery unit (FJBU)

6.5.1 Installing an FJBU



Customer Replaceable
Unit (CRU)



Hardware: 5 minutes

Tools: tool-less

Preliminary steps

No steps needed.

Removing the dummy cover

- ▶ Remove the dummy cover, see ["Removing the PSU dummy cover" on page 116](#).

Installing an FJBU



Figure 57: Installing an FJBU

Power supply unit (PSU)

- ▶ Push the FJBU into its bay as far as it will go until the locking latch snaps in place.



CAUTION

- ▶ Ensure that the FJBU properly engages in its bay and is locked in position in order to prevent it from sliding out of the chassis during transportation.

Concluding steps

No steps needed.

6.5.2 Removing an FJBU



Customer Replaceable Unit (CRU)



Hardware: 5 minutes

Tools: tool-less

Preliminary steps

No steps needed.

Removing an FJBU

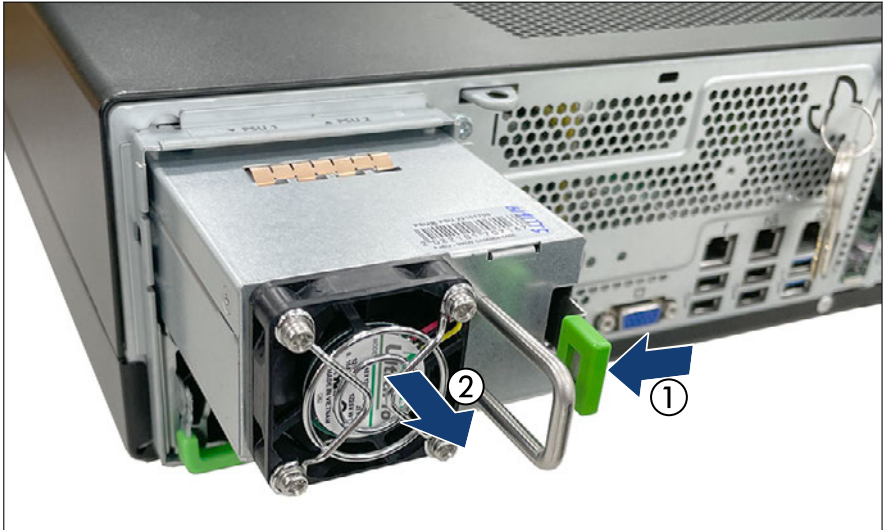

Figure 58: Removing an FJBU

- ▶ Press in on the green locking latch (1).
- ▶ While keeping the green locking latch pressed, pull the FJBU out of its bay (2).



CAUTION

- ▶ Never leave the bay for the FJBU empty.
- ▶ Install a new FJBU or install the dummy cover.

Installing the dummy cover

- ▶ Install the dummy cover, see ["Installing the PSU dummy cover" on page 121](#).

Concluding steps

No steps needed.

6.5.3 Replacing an FJBU



Customer Replaceable Unit (CRU)



Hardware: 5 minutes

Tools: tool-less

Preliminary steps

- ▶ ["Locating the defective server" on page 45.](#)

Removing the defective FJBU

- ▶ Remove the FJBU, see ["Removing an FJBU" on page 132.](#)

Installing the new FJBU

- ▶ Install the FJBU, see ["Installing an FJBU" on page 131.](#)

Concluding steps

- ▶ No steps needed.

7 Hard disk drive (HDD) / solid state drive (SSD)

7.1 Safety notes



CAUTION

- ▶ Before removing several HDD/SSD modules, make sure that all HDD/SSD modules can be reinstalled into their original bay. Otherwise, data may be lost.
- ▶ Do not touch the circuitry on boards or soldered parts. Hold circuit boards by their metallic areas or edges.
- ▶ Before removing an HDD, wait for about 30 seconds until the disk has stopped spinning completely.
- ▶ When an HDD is starting up, a resonant noise may be audible for a short while. This does not indicate a failure.
- ▶ Depending on the OS, you can configure the write cache settings for the HDDs. If a power failure should occur while the write cache is enabled, cached data may be lost.
- ▶ When disposing of, transferring, or returning an HDD or SSD, wipe out the data on the drive for your own security.
- ▶ Rough handling of HDDs may damage the stored data. To cope with any unexpected problems, always back up important data. When backing up data to another HDD, you should make backups on a file or partition basis.
- ▶ Be careful not to hit the HDD or bring it into contact with metallic objects.
- ▶ Handle the HDD and SSD on a shock and vibration free surface.
- ▶ Do not use the HDD and SSD in extremely hot or cold locations, or locations with extreme temperature changes.
- ▶ Never attempt to disassemble the HDD or SSD.
- ▶ For more information, see ["Important information" on page 31](#).

7.2 Basic information

The HDD or SSD and the installation frame together make up the HDD module or SSD module.

The server is shipped with one of the following HDD or SSD subsystems:

- 3.5-inch HDD subsystem
- 2.5-inch HDD/SSD subsystem



For information on RAID controllers controlling the HDD/SSD modules see ["Expansion cards and backup units" on page 185](#).

3.5-inch HDD subsystem

Up to two 3.5-inch non hot-plug SATA HDDs can be installed. The HDDs are connected to the related controller with a cable.



For information on RAID controllers controlling the HDD modules see ["Expansion cards and backup units" on page 185](#).

2.5-inch HDD/SSD subsystem

Up to eight 2.5-inch SAS/SATA HDD/SSD modules or up to four SAS/SATA HDD/SSD modules and up to four PCIe SSD can be installed. The module is connected to the HDD/PCIe backplane wirelessly. This allows HDD/SSD modules to be plugged in or pulled out easily.



For information on RAID controllers controlling the HDD/SSD modules see ["Expansion cards and backup units" on page 185](#).

Position of the backplanes

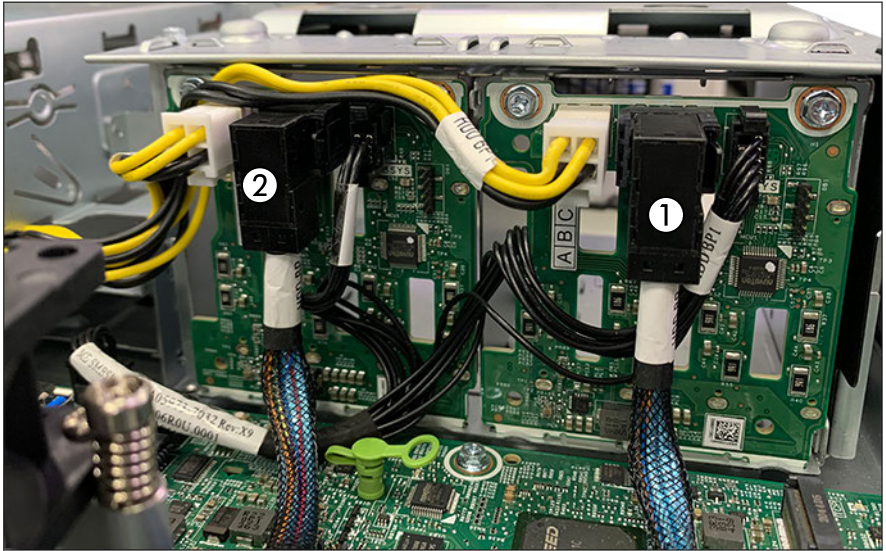

Figure 59: Position of the backplanes

1 HDD backplane 1

2 HDD backplane 2

7.3 Handling HDDs or SSDs without installation frame

7.3.1 2.5-inch HDD/SSD and 2.5-inch installation frame



Installing or removing the installation frame is only necessary for Japan.



Customer Replaceable Unit (CRU)



Hardware: 5 minutes

Tools: Phillips PH1 / (+) No. 1 screw driver

Hard disk drive (HDD) / solid state drive (SSD)

Preliminary steps

No steps needed.

Installing a 2.5-inch HDD/SSD in a 2.5-inch installation frame



Figure 60: Installing the 2.5-inch HDD/SSD in the 2.5-inch installation frame (A)

- Lay the 2.5-inch HDD/SSD into the 2.5-inch installation frame as shown.



Figure 61: Installing the 2.5-inch HDD/SSD in the 2.5-inch installation frame (B)

- Fasten the 2.5-inch HDD/SSD with four screws.

Removing a 2.5-inch HDD/SSD from a 2.5-inch installation frame

- ▶ Please proceed in reversed order.

Concluding steps

No steps needed.

7.4 3.5-inch HDD configurations

7.4.1 Configuration with up to two 3.5-inch HDDs



Figure 62: Configuration with up to two 3.5-inch HDDs

The HDD numbering as listed in the iRMC S6 web interface:

Position	Logical drive number	iRMC S6 web interface
[0]	0	Slot (0)
[1]	1	Slot (1)

7.4.2 Installing 3.5-inch non hot-plug HDDs



Upgrade and Repair Unit
(URU)



Hardware: 5 minutes

Tools: tool-less

Preliminary steps

- ▶ "Shutting down the server" on page 47.
- ▶ "Disconnecting the power cord" on page 48.
- ▶ "Getting access to the component" on page 50.

Installing a 3.5-inch non hot-plug HDD

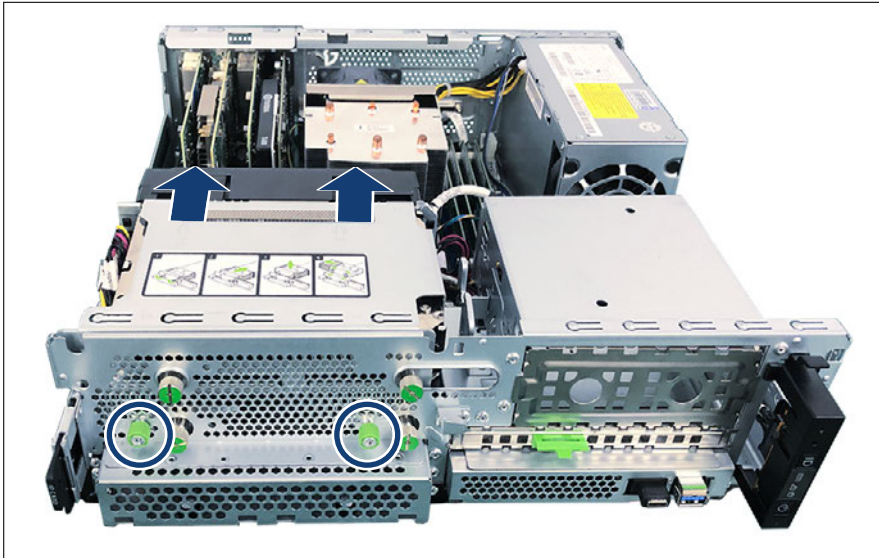

Figure 63: Installing a 3.5-inch non hot-plug HDD (A)

- ▶ Loosen the two knurled screws (see circles).
- ▶ Slide the HDD cage in the direction of the arrows.

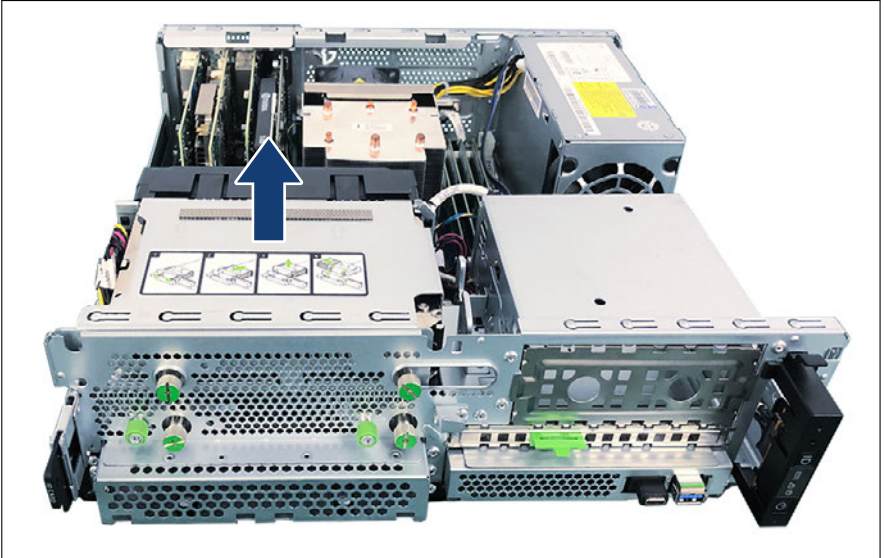

Figure 64: Installing a 3.5-inch non hot-plug HDD (B)

- Remove the HDD cage in the direction of the arrow.

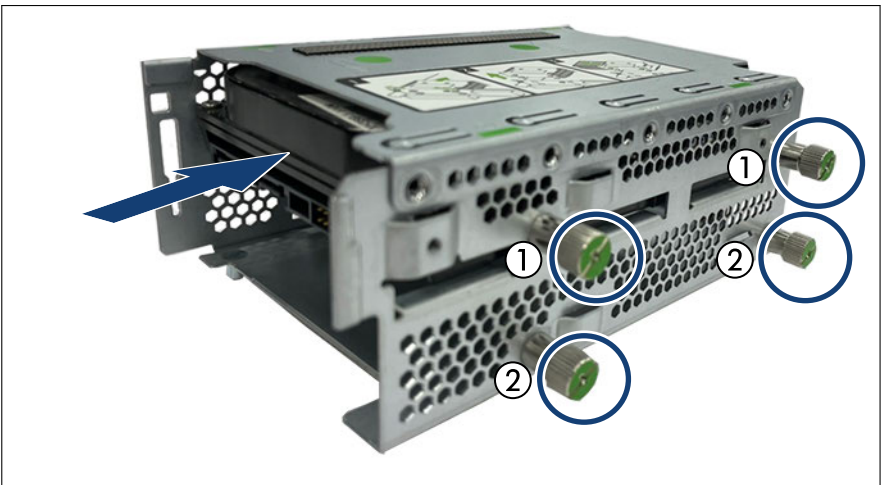

Figure 65: Installing a 3.5-inch non hot-plug HDD (C)

Hard disk drive (HDD) / solid state drive (SSD)

- ▶ Insert the first HDD module into the HDD cage in HDD bay 0 and carefully push back as far as it will go.
- ▶ Fasten the knurled screws (see circles, 1).
- ▶ If applicable, proceed with the second HDD module in HDD bay 1 in the same way.
- ▶ Fasten the two knurled screws (see circles, 2).

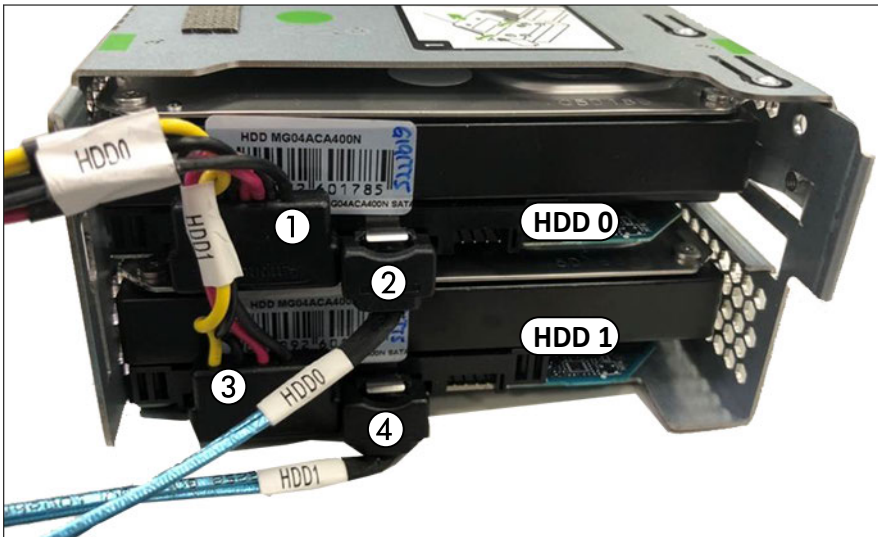

Figure 66: Connecting the 3.5-inch non hot-plug HDD(s)

- ▶ Connect the cable to HDD 0 or HDD 1:
 - 1 Power cable connector to HDD 0
 - 2 SATA cable connector to HDD 0.
 - 3 If applicable, power cable connector to HDD 1.
 - 4 If applicable, SATA cable connector to HDD 1.

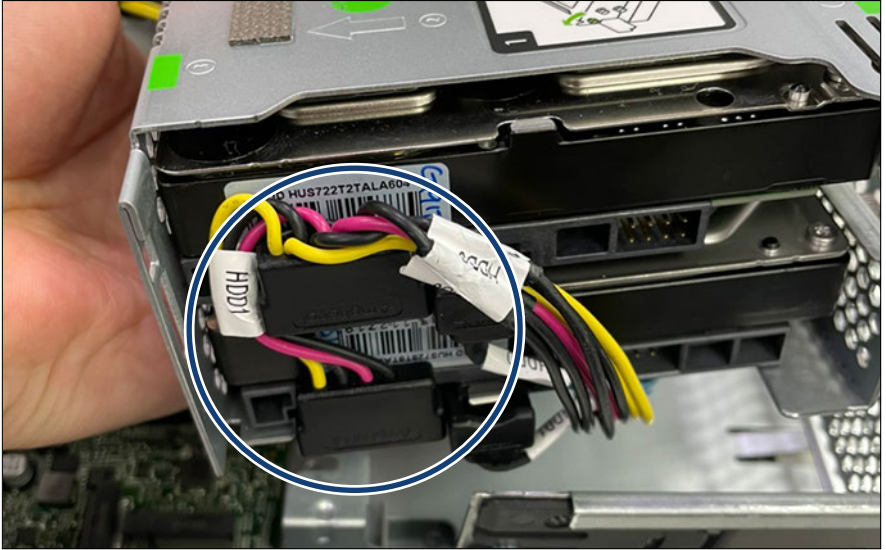

Figure 67: Routing the cables (A)

- ▶ Route the power cable as shown (see circle).

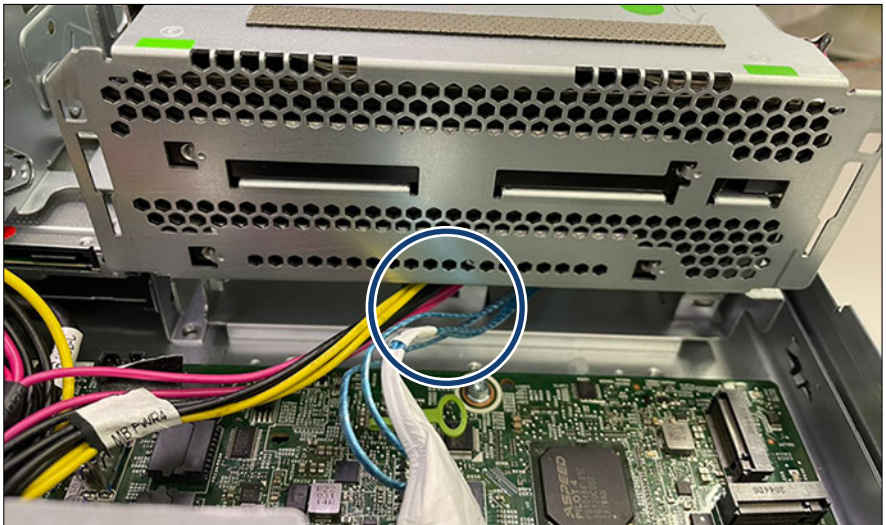

Figure 68: Routing the cables (B)

Hard disk drive (HDD) / solid state drive (SSD)

- ▶ Route the power cable and the SATA cable under the HDD cage as shown (see circle).



Figure 69: Routing the cables

- ▶ Route the cables under the HDD cage.
- ▶ Hold the HDD cage with the cables and install the HDD cage in a slight angle.



Figure 70: Fastening the screws

- ▶ Fasten the two knurled screws (see circles).

Concluding steps

- ▶ ["Reassembling" on page 56.](#)
- ▶ ["Connecting the power cord" on page 59.](#)
- ▶ ["Switching on the server" on page 63.](#)



To configure the installed HDD, see your controller manual.

7.4.3 Removing 3.5-inch non hot-plug HDDs



Upgrade and Repair Unit (URU)





Hardware: 5 minutes

Tools: tool-less

Preliminary steps

- ▶ If the HDD to be removed is combined into a RAID array, proceed as follows:

RAID level	Procedure
RAID 0	 CAUTION RAID 0 provides no data redundancy. In case of an HDD/SSD module is defect, all data are lost!
RAID 1 RAID 5	Removing an HDD module from a RAID 1 or RAID 5 array will not result in data loss. However, the removed drive needs to be replaced immediately by an HDD module of the same or larger capacity.  After replacing the HDD module, RAID rebuild will be performed as a background process, see "Performing a RAID array rebuild" on page 91 .

In order to permanently remove an operational HDD that is part of a RAID array from the server, you first need to delete the array using the iRMC S6 web interface.



CAUTION

All data on all HDDs/SSDs in the array will be lost when deleting the RAID array!

- ▶ Be sure to back up your data before deleting a RAID array.
 - ▶ For more information, see the "iRMC S6 - Web Interface" user guide.
- ▶ ["Shutting down the server" on page 47](#).
 - ▶ ["Getting access to the component" on page 50](#).

Removing a 3.5-inch non hot-plug HDD

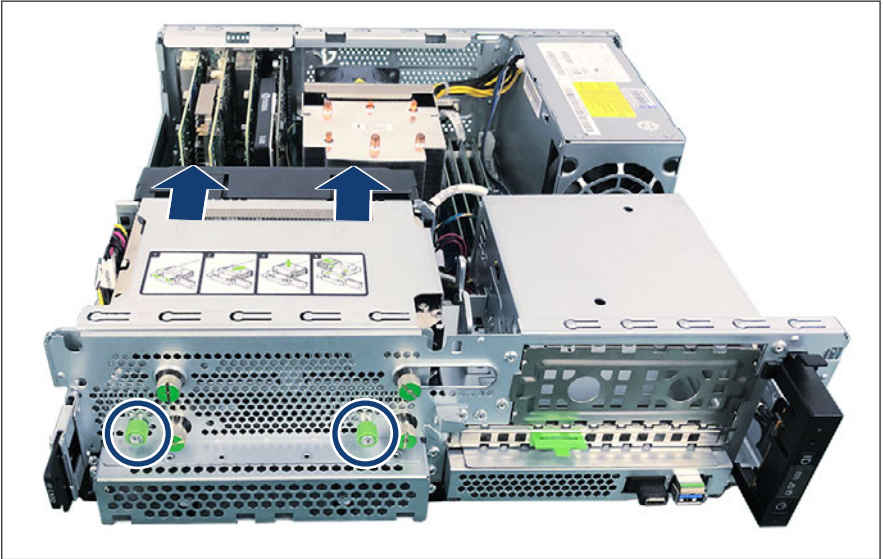

Figure 71: Removing the HDD cage (A)

- ▶ Loosen the two knurled screws from the HDD cage (see circles).
- ▶ Slide the HDD cage in the direction of the arrows.

Hard disk drive (HDD) / solid state drive (SSD)

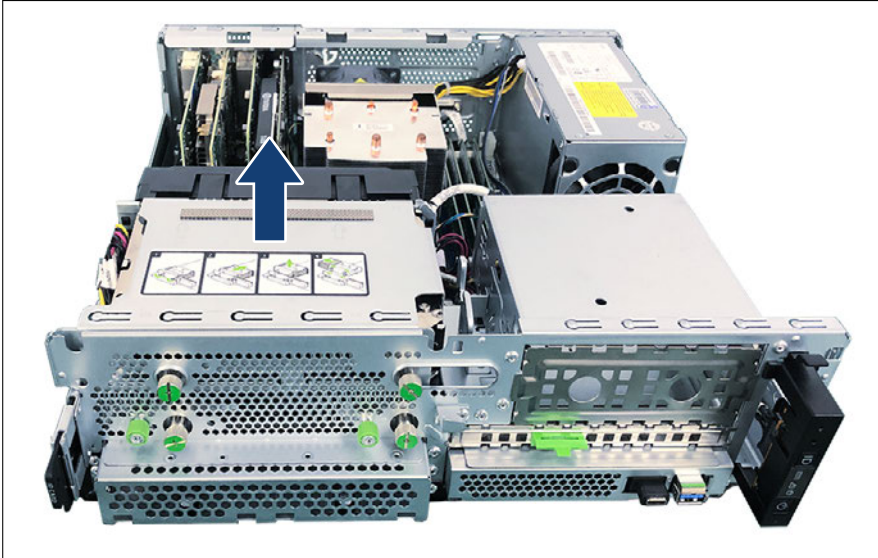

Figure 72: Removing the HDD cage (B)

- ▶ Remove the HDD cage in the direction of the arrow.

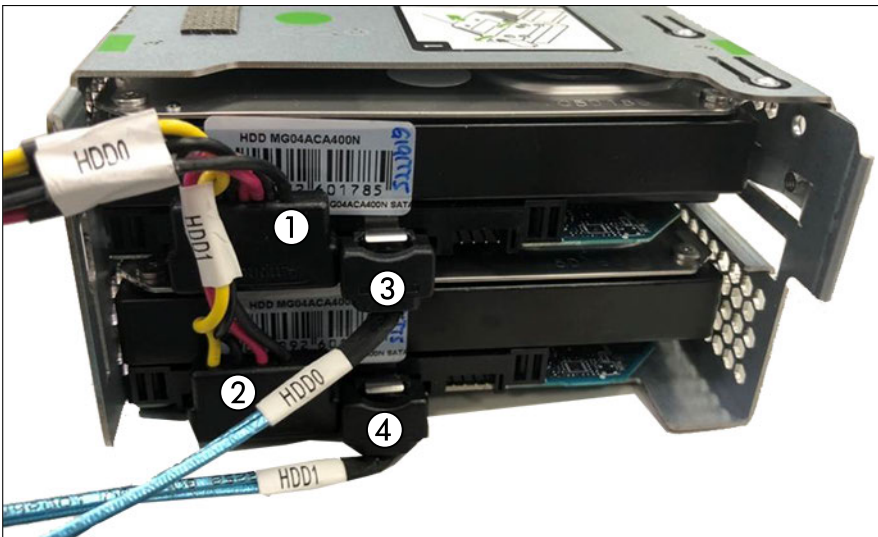

Figure 73: Disconnecting the 3.5-inch non hot-plug HDD(s)

- ▶ Disconnect the power cable(s) from the HDD to be removed (1, 2).
- ▶ Disconnect the SATA cable(s) from the HDD to be removed (3, 4).

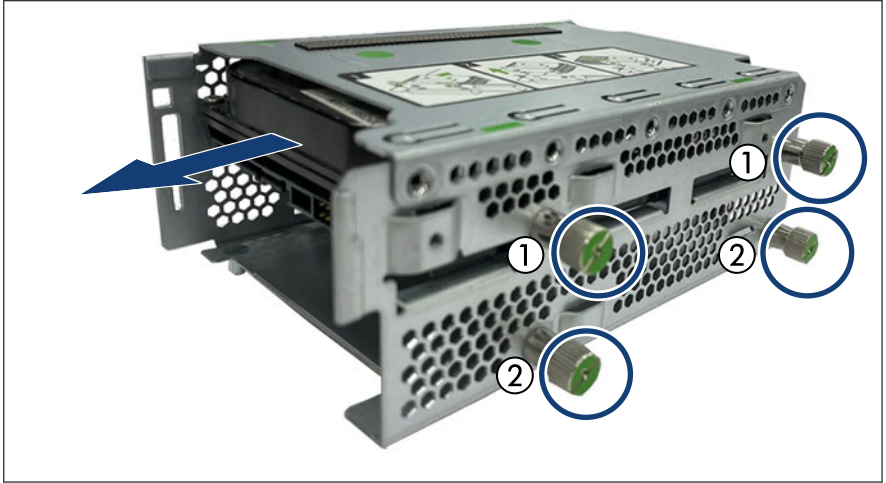

Figure 74: Removing a 3.5-inch non hot-plug HDD

- ▶ Loosen the knurled screws (see circles, 1).
- ▶ Remove the first HDD module from the HDD cage.
- ▶ If applicable, loosen the two knurled screws (see circles, 2).
- ▶ If applicable, proceed with the second HDD module in HDD bay 1 in the same way.

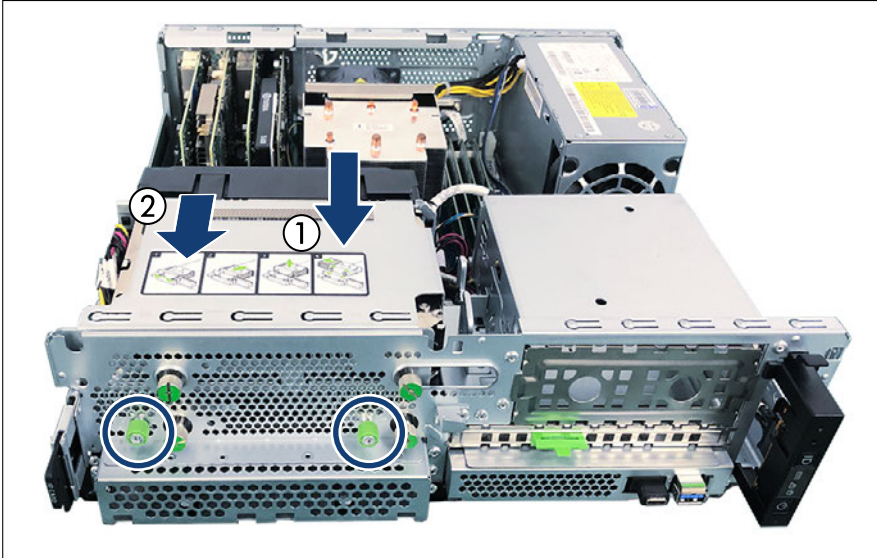

Figure 75: Installing the HDD cage

- ▶ Insert the HDD cage (1).
- ▶ Slide the HDD cage in the direction of the arrow (2).
- ▶ Fasten the two knurled screws of the HDD cage (see circles).

Concluding steps

- ▶ ["Reassembling" on page 56.](#)
- ▶ ["Connecting the power cord" on page 59.](#)
- ▶ ["Switching on the server" on page 63.](#)

7.4.4 Replacing a 3.5-inch non hot-plug HDD



Upgrade and Repair Unit (URU)



Hardware: 10 minutes

Tools: tool-less

Preliminary steps

- ▶ ["Locating the defective server" on page 45.](#)
- ▶ ["Locating the defective component" on page 46.](#)
- ▶ ["Shutting down the server" on page 47.](#)
- ▶ ["Getting access to the component" on page 50.](#)

Removing the defective 3.5-inch non hot-plug HDD

- ▶ Remove the non hot-plug HDD, see ["Removing 3.5-inch non hot-plug HDDs" on page 145.](#)

Installing the new 3.5-inch non hot-plug HDD

- ▶ Install the non hot-plug HDD, see ["Installing 3.5-inch non hot-plug HDDs" on page 140.](#)

Concluding steps

- ▶ ["Reassembling" on page 56.](#)
- ▶ ["Connecting the power cord" on page 59.](#)
- ▶ ["Switching on the server" on page 63.](#)
- ▶ If the HDD/SSD is configured using a RAID controller with a RAID level higher than "0", the rebuild will start automatically, see ["Performing a RAID array rebuild" on page 91.](#)

7.5 2.5-inch HDD/SSD configurations

7.5.1 Configuration with up to four HDD/SSD modules

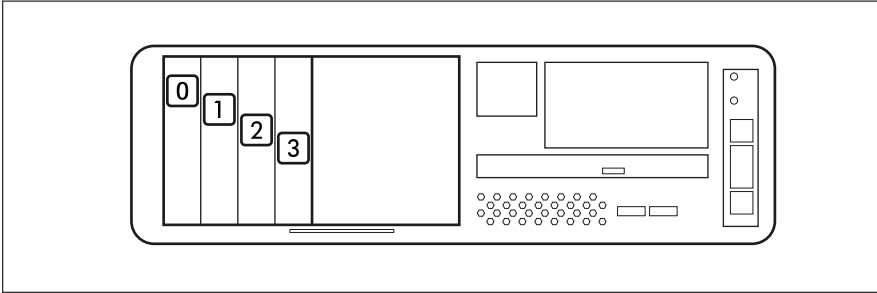

Figure 76: Configuration with up to four 2.5-inch HDDs/SSDs

Position	Logical drive number	iRMC S6 web interface
[0]	0	Slot (0)
[1]	1	Slot (1)
[2]	2	Slot (2)
[3]	3	Slot (3)

7.5.2 Configuration with up to eight HDD/SSD modules

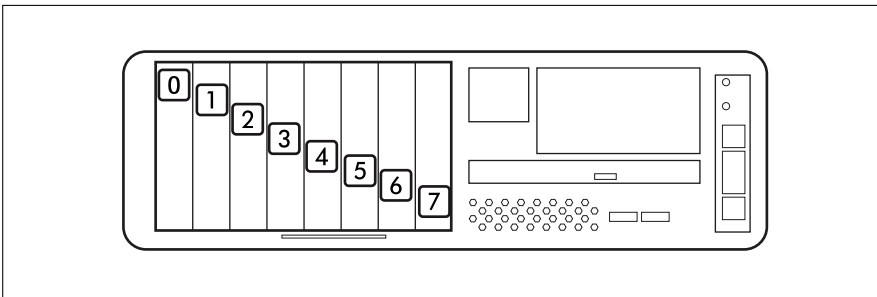

Figure 77: Configuration with up to eight 2.5-inch HDDs/SSDs

Position	Logical drive number	iRMC S6 web interface
[0]	0	Slot (0)
[1]	1	Slot (1)
[2]	2	Slot (2)
[3]	3	Slot (3)
[4]	4	Slot (4)
[5]	5	Slot (5)
[6]	6	Slot (6)
[7]	7	Slot (7)

i If a server system has been configured without any HDDs, keep the HDD bay marked with “Test” free for test purposes. During hardware checks, a HDD will be installed into this bay. Afterwards this HDD is replaced by a HDD dummy module.

7.5.3 Configuration with up to four PCIe SSD modules

i In the configuration with up to eight HDD/SSD modules, the first four HDD bays can be equipped with PCIe SSD modules via onboard Oculink connection and a PCIe backplane.

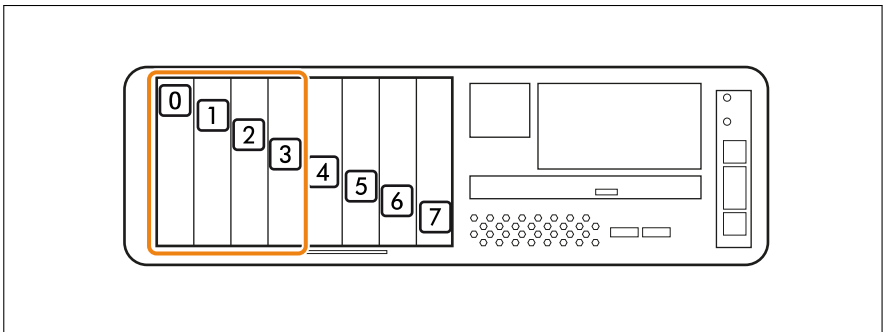

Figure 78: Configuration with up to four PCIe SSDs

With the 4x 2.5-inch PCIe SSD backplane

Position	Logical drive number	iRMC S6 web interface
[0]	0	Slot (0)
[1]	1	Slot (1)
[2]	2	Slot (2)
[3]	3	Slot (3)

7.5.4 Installing 2.5-inch HDD/SSD modules



Customer Replaceable Unit (CRU)



Hardware: 5 minutes

Tools: tool-less

Preliminary steps

- ▶ ["Getting access to the component" on page 50.](#)
- ▶ Locate the correct drive bay, see ["2.5-inch HDD/SSD configurations" on page 152.](#)

Removing a 2.5-inch HDD/SSD dummy module

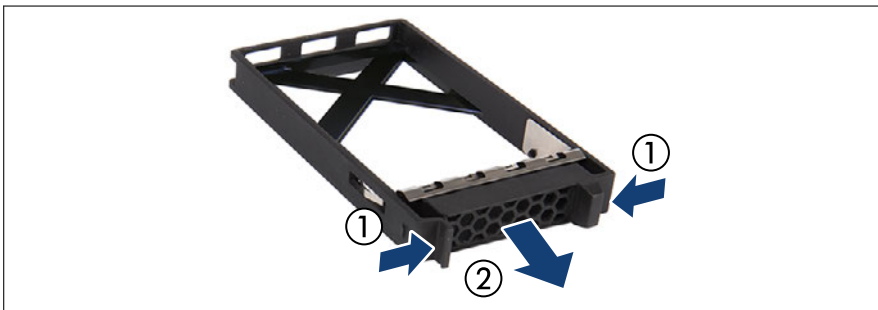

Figure 79: Removing a 2.5-inch HDD/SSD dummy module

- ▶ Press both tabs together (1) and pull the dummy module out of its bay (2).



CAUTION

- ▶ Keep the dummy module for future use.
- ▶ Always replace dummy modules into unused HDD/SSD bays to comply with applicable EMC regulations and satisfy cooling requirements.

Installing a 2.5-inch HDD/SSD module



Figure 80: Opening the locking lever

- ▶ Pinch the green locking clips (1) and open the locking lever (2).

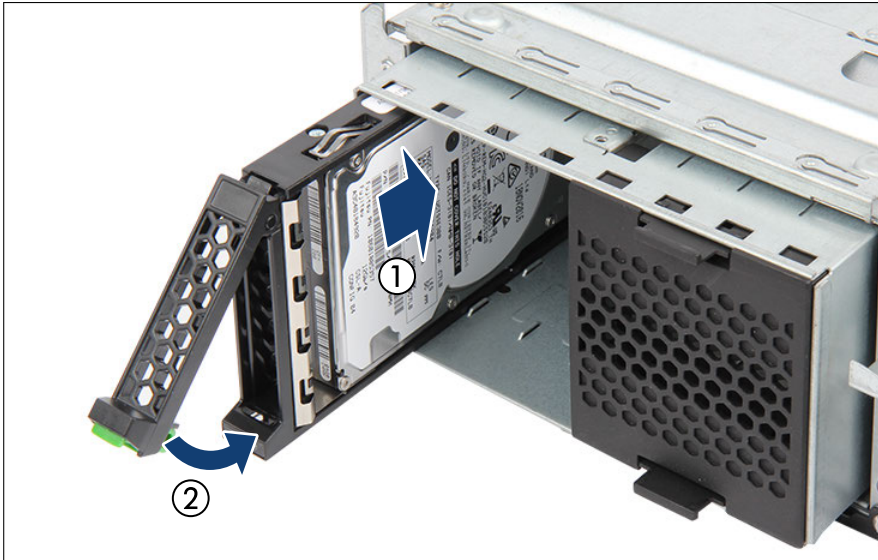

Figure 81: Installing the 2.5-inch HDD/SSD module

- ▶ Insert the HDD/SSD module into a drive bay and carefully push back as far as it will go (1).
- ▶ Close the locking lever to lock the HDD/SSD module in place (2).
- ▶ When using a RAID array, add the additional HDD/SSD to the RAID array.



Configuring the RAID array, see the documentation of the RAID controller, used in your configuration, see ["Documentation overview" on page 28](#).

Concluding steps

- ▶ ["Reassembling" on page 56](#).

7.5.5 Removing 2.5-inch HDD/SSD modules



Customer Replaceable Unit (CRU)





Hardware: 5 minutes

Tools: tool-less

Preliminary steps

- ▶ If the HDD/SSD module to be removed is combined into a RAID array, proceed as follows:

RAID level	Procedure
RAID 0	 CAUTION RAID 0 provides no data redundancy. In case of an HDD/SSD module is defect, all data are lost!
RAID 1 RAID 5	Removing an HDD/SSD module from a RAID 1 or RAID 5 array will not result in data loss. However, the removed drive needs to be replaced immediately by an HDD/SSD module of the same or larger capacity.  After replacing the HDD/SSD module, RAID rebuild will be performed as a background process, see "Performing a RAID array rebuild" on page 91 .

In order to permanently remove an operational HDD/SSD module that is part of a RAID array from the server, you first need to delete the array using the iRMC S6 web interface.



CAUTION

All data on all HDDs/SSDs in the array will be lost when deleting the RAID array!

- ▶ Be sure to back up your data before deleting a RAID array.
 - ▶ For more information, see the "iRMC S6 - Web Interface" user guide.
- ▶ ["Getting access to the component" on page 50](#).

Removing a 2.5-inch HDD/SSD module

- ▶ Pinch the green locking clips and open the locking lever (see [Figure 80](#)).
- ▶ Pull the HDD/SSD module out a few centimeters.
- ▶ Wait about 30 seconds to allow the HDD to spin down.



This is not necessary when removing an SSD.



This period is necessary for the RAID controller to recognize that an HDD module has been removed and for the HDD to come to a stop.

- ▶ Pull the HDD/SSD module completely out of its bay.

Installing a 2.5-inch HDD/SSD dummy module



CAUTION

- ▶ If the removed HDD/SSD module is not replaced immediately, always replace a dummy module into the unused HDD/SSD bay to comply with applicable EMC regulations and satisfy cooling requirements.

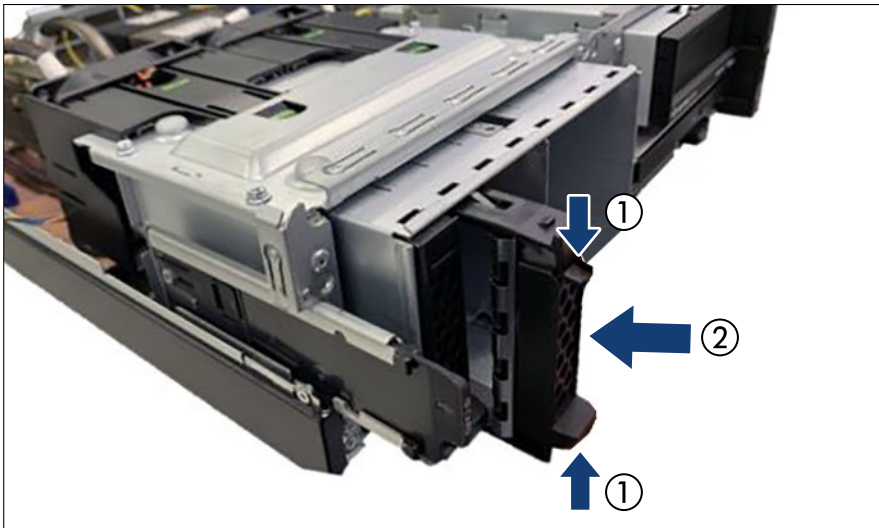

Figure 82: Installing the 2.5-inch HDD/SSD dummy module

- ▶ Press both tabs together (1) and push the HDD dummy module into the empty HDD bay until it engages (2).

Concluding steps

["Reassembling" on page 56.](#)

7.5.6 Replacing a 2.5-inch HDD/SSD module



Customer Replaceable Unit (CRU)



Hardware: 5 minutes

- | | |
|---------------|---|
| Tools: | <ul style="list-style-type: none">– Installation frame included: tool-less– Installation frame excluded: Phillips PH1 / (+) No. 1 screw driver |
|---------------|---|



CAUTION

- ▶ Only remove an HDD/SSD module during operation if the drive is not currently being accessed. Observe the indicators on the corresponding HDD/SSD module, see ["Indicators on hot-plug HDD / SSD / PCIe SSD modules" on page 379](#).
- ▶ An HDD/SSD module can be replaced while the system is in operation. **RAID configuration with a RAID controller:**
 - Modular Host Bus Adapter with "Integrated RAID" (IR). RAID levels 0 and 1 are supported for internal HDD configurations.
 - Modular RAID 0/1 controller with "MegaRAID functionality" (integrated MegaRAID). RAID levels 0, 1, 10, 5 and 50 are supported for internal HDD configurations.
 - Modular RAID 5/6 controller with "MegaRAID functionality" (MegaRAID). RAID levels 0, 1, 10, 5, 50, 6 and 60 are supported for internal HDD configurations. As an option, a flash backup unit (FBU) can save the memory content even if the power fails. Cache memory size of up to 8 GB is available.
- ▶ An HDD/SSD module can be replaced while the system is in operation. **RAID configuration without a RAID controller:**

Please follow the instruction of each software e.g. VSAN, Storage Spaces, and Storage Spaces Direct, provided separately to use the software RAID function of OS or Hypervisor.
- ▶ All HDD/SSD modules (drives) must be uniquely identified so that they can be reinstalled in their original bays later. If this is not done, existing data can be lost.

Preliminary steps

- ▶ ["Locating the defective server" on page 45](#).
- ▶ ["Getting access to the component" on page 50](#).
- ▶ ["Locating the defective component" on page 46](#).

Removing the defective 2.5-inch HDD/SSD module

- ▶ Remove the HDD/SSD module, see ["Removing 2.5-inch HDD/SSD modules" on page 156](#).
- ▶ If applicable, remove the HDD/SSD from the installation frame, see ["Handling HDDs or SSDs without installation frame" on page 137](#).

Installing the new 2.5-inch HDD module

- ▶ If applicable, install the HDD/SSD in the installation frame, see ["Handling HDDs or SSDs without installation frame" on page 137](#).
- ▶ Install the HDD/SSD module, see ["Installing 2.5-inch HDD/SSD modules" on page 154](#).

Concluding steps

- ▶ If the HDD/SSD is configured using a RAID controller with a RAID level higher than "0", the rebuild will start automatically, see ["Performing a RAID array rebuild" on page 91](#).
- ▶ ["Reassembling" on page 56](#).

7.5.7 Replacing a 2.5-inch backplane



Field Replaceable Unit (FRU)



Hardware: 10 minutes

Tools: Phillips PH2 / (+) No. 2 screw driver

Preliminary steps



If a PCIe backplane should be installed, remove the HDD backplane from the first place and install it as the second backplane. The PCIe backplane is always installed as the first backplane.



The HDD backplane is mounted on the HDD cage. It is not necessary to remove the HDD cage before installing or removing the HDD backplane.

- ▶ ["Locating the defective server" on page 45.](#)
- ▶ ["Shutting down the server" on page 47.](#)
- ▶ ["Disconnecting the power cord" on page 48.](#)
- ▶ ["Getting access to the component" on page 50.](#)
- ▶ Remove the HDD fan module (2.5-inch HDD variant), see ["Removing the HDD fan module \(2.5-inch HDD variant\)" on page 70.](#)
- ▶ Release all HDD modules and pull them out a few centimeters, see ["Removing 2.5-inch HDD/SSD modules" on page 156.](#)



CAUTION

The HDD modules need not to be removed.

- ▶ If you want to remove them nevertheless, check if all HDD modules are uniquely identified so that you can reinsert them into their original bays.
- ▶ Release all dummy modules and pull them out a few centimeters, see ["Removing a 2.5-inch HDD/SSD dummy module" on page 154.](#)

Removing a 2.5-inch HDD/PCIe backplane



The following description is valid for:

- An HDD backplane
- A PCIe backplane



Configurations with up to four 2.5-inch HDDs/SSDs, there is one HDD backplane. Configurations with up to eight 2.5-inch HDDs/SSDs, there are either two HDD backplanes or one PCIe backplane (backplane 1) and one HDD backplane (backplane 2).

- ▶ If there are two backplanes, locate the defective backplane.
- ▶ If applicable, disconnect all cables from the backplane(s).

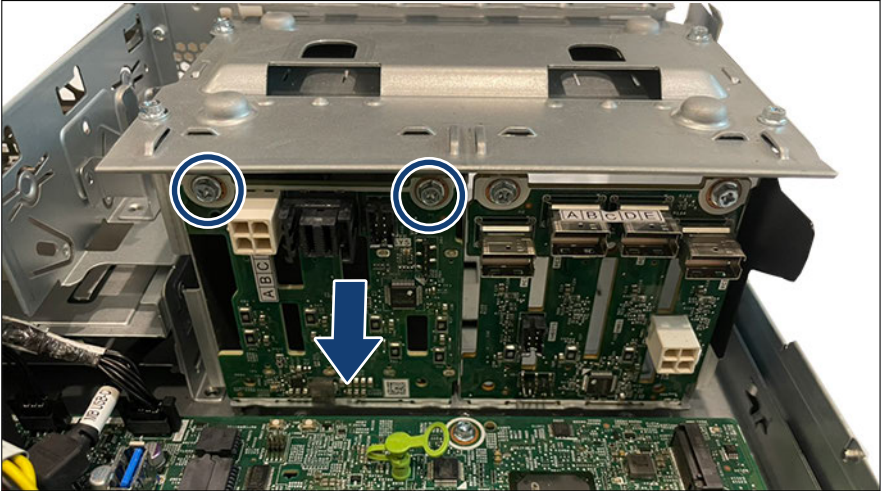

Figure 83: Removing a backplane - example HDD backplane (backplane 2)

- ▶ Remove the two screws (see circles).
- ▶ Remove the selected backplane from the HDD cage.

Installing a 2.5-inch HDD/PCIe backplane

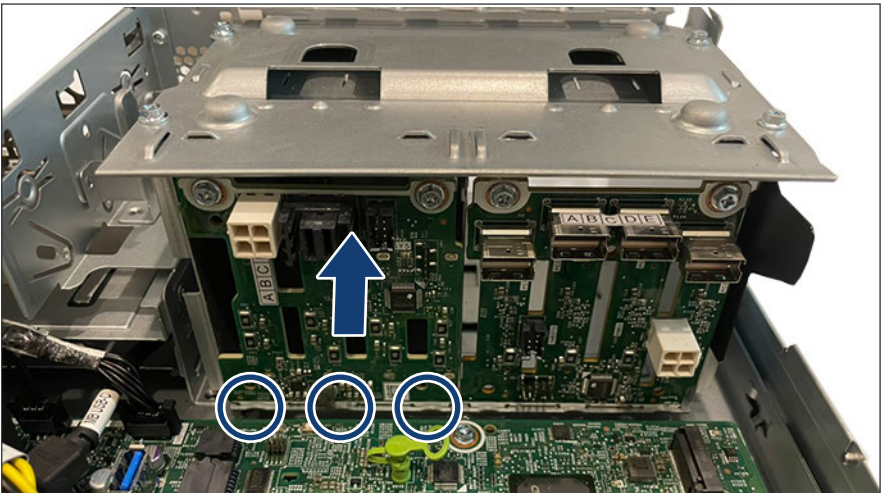

Figure 84: Installing a backplane - example HDD backplane (backplane 2)

Hard disk drive (HDD) / solid state drive (SSD)

- ▶ Place the HDD backplane in the three hooks on the bottom of the HDD cage (see circles).

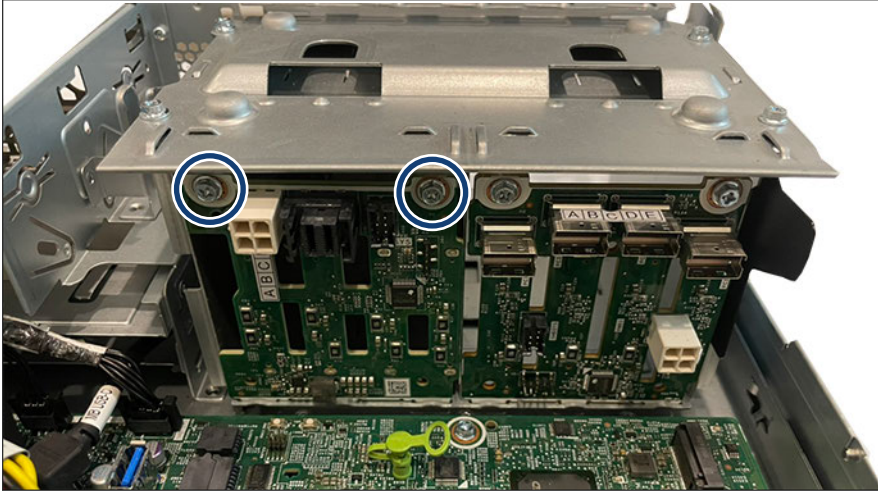

Figure 85: Fastening the screws

- ▶ Fasten the two screws (see circles).

Connecting cables

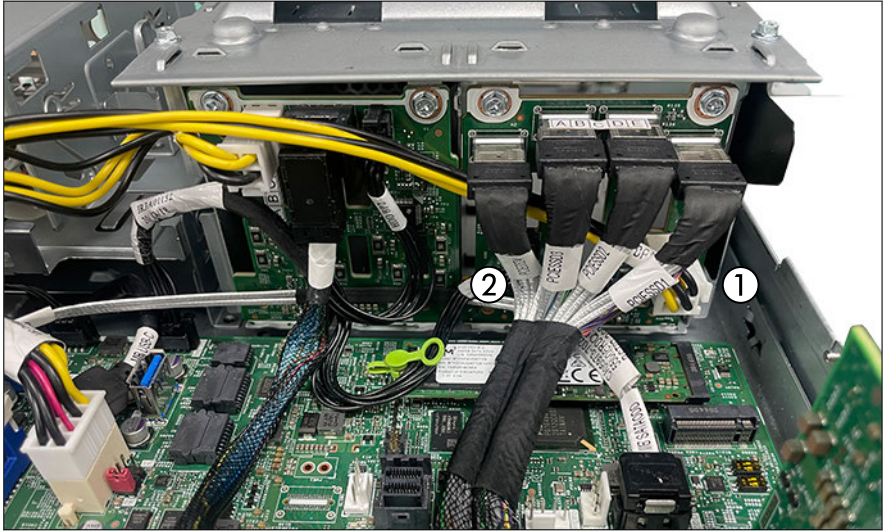

Figure 86: Example: Connecting cables to a PCIe backplane (A)

- ▶ Connect the cables to the PCIe backplane:
 - 1 Power cable to the connector “PWR1”
 - 2 OOB cable to the connector “SMBSYS”
- ▶ Run the power cable as shown.

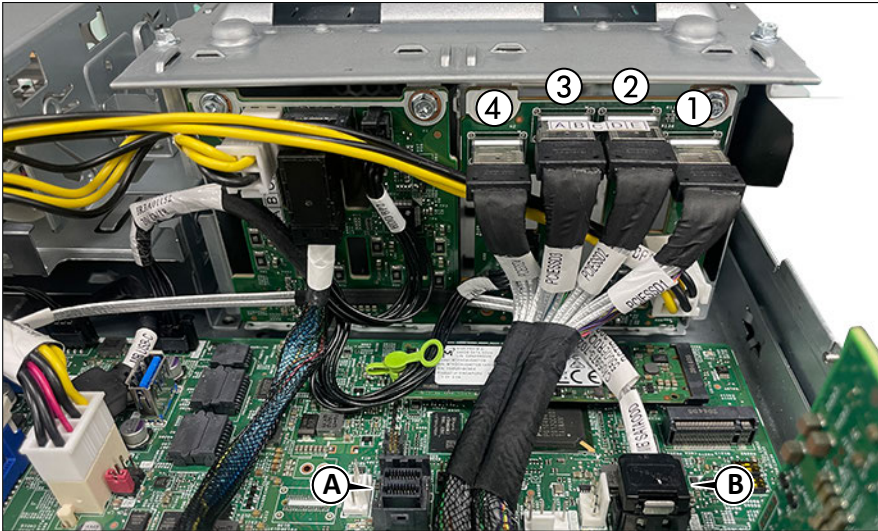

Figure 87: Example: Connecting cables to a PCIe backplane (B)

- ▶ Connect the NVMe cables to the PCIe backplane:
 - 1 Connector "PCIe SSD1"
 - 2 Connector "PCIe SSD2"
 - 3 Connector "PCIe SSD3"
 - 4 Connector "PCIe SSD4"
- ▶ If applicable, place the free connectors in an empty bay.
- ▶ Route the NVMe cables horizontally between the SATA connector (A) and the fan connector (B).



For the cable plan, see ["Appendix B" on page 391](#).

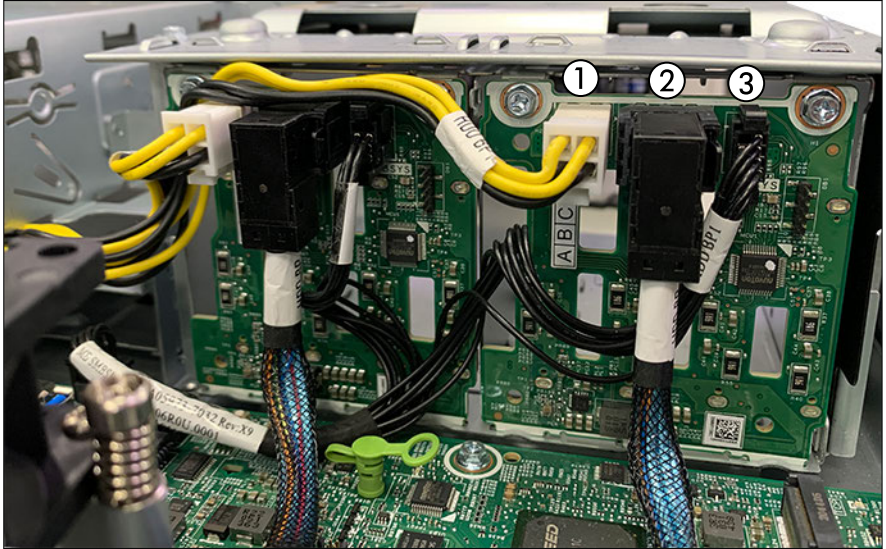

Figure 88: Example: Connecting cables to an HDD backplane

- ▶ Connect the cables to the HDD backplane:
 - 1 Power cable to the connector “PWR1”
 - 2 Signal cable to the connector “P1”
 - 3 OOB cable to the connector “SMBSYS”
- ▶ If applicable, place the free connectors in an empty bay.
- ▶ Run the cables as shown.

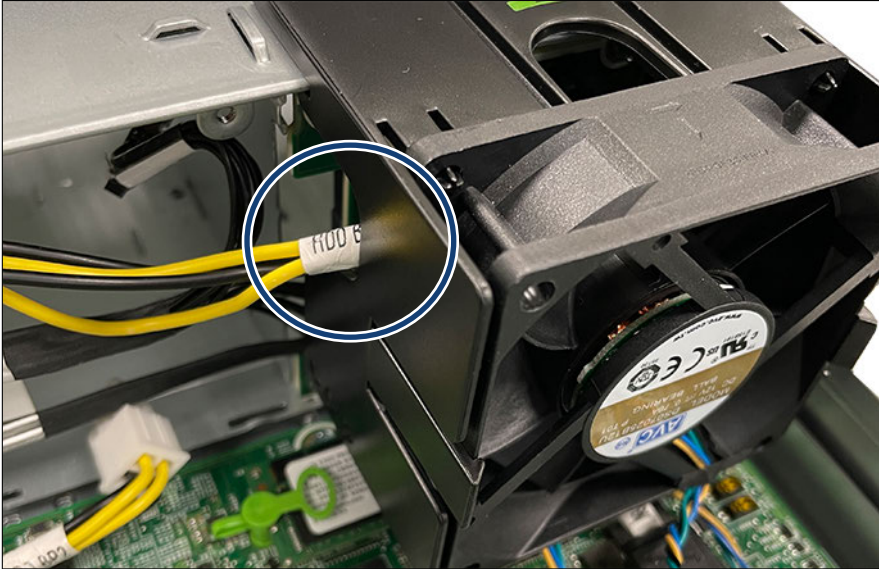

Figure 89: Routing the power cable

- ▶ Route the power cable under the HDD fan module (see circle).



For the cable plan, see ["Appendix B" on page 391](#).

Concluding steps

- ▶ Insert all HDD modules, see ["Installing 2.5-inch HDD/SSD modules" on page 154](#).



Ensure that you install the HDD/SSD module in the bay it was located before the HDD backplane replacement.

- ▶ Install the HDD fan modules 2.5-inch HDD variant, see ["Installing the HDD fan module \(2.5-inch HDD variant\)" on page 71](#).
- ▶ ["Reassembling" on page 56](#).
- ▶ ["Connecting the power cord" on page 59](#).
- ▶ ["Switching on the server" on page 63](#).

7.5.8 Upgrading configuration from up to four to up to eight 2.5-inch HDDs/SSDs



Field Replaceable Unit (FRU)



Hardware: 10 minutes

Tools: Phillips PH2 / (+) No. 2 screw driver



CAUTION

All data on all HDDs/SSDs in the array will be lost when deleting the RAID array!

- ▶ Be sure to back up your data before deleting a RAID array.
- ▶ For more information, see the "iRMC S6 - Web Interface" user guide.



After installing or removing an additional backplane, never forget to change the system information using the Chassis ID Prom Tool.

Preliminary steps



The HDD backplane is mounted on the HDD cage. It is not necessary to remove the HDD cage before installing or removing the HDD backplane.

- ▶ ["Shutting down the server" on page 47.](#)
- ▶ ["Disconnecting the power cord" on page 48.](#)
- ▶ ["Getting access to the component" on page 50.](#)
- ▶ Remove the HDD fan modules, see ["Removing the HDD fan module \(2.5-inch HDD variant\)" on page 70.](#)

Installing the second HDD backplane

- ▶ Install the HDD backplane 2, see ["Installing a 2.5-inch HDD/PCIe backplane" on page 163](#).
- ▶ Connect cables to the HDD backplane 2, see ["Connecting cables" on page 165](#).



For the cable plan, see ["Appendix B" on page 391](#).

Installing additional HDD/SSD modules

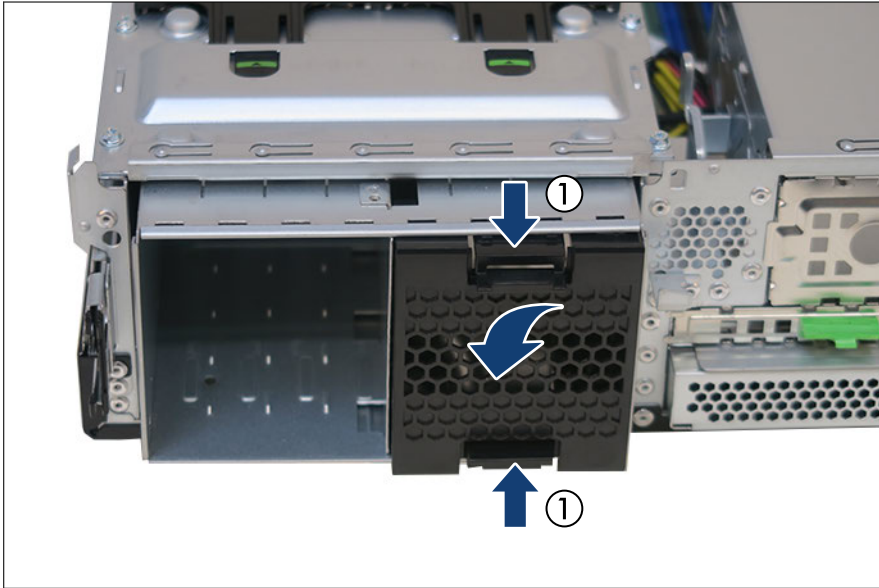

Figure 90: Removing the HDD dummy cover

- ▶ Press in on both release latches (1) and remove the HDD dummy cover.
- ▶ Insert additional HDD/SSD modules, see ["Installing 2.5-inch HDD/SSD modules" on page 154](#).

Concluding steps

- ▶ Install the HDD fan modules, see ["Installing the HDD fan module \(2.5-inch HDD variant\)" on page 71](#).
- ▶ ["Reassembling" on page 56](#).
- ▶ ["Connecting the power cord" on page 59](#).
- ▶ Update the system information of your server using the Chassis ID Prom Tool, see ["Using the Chassis ID Prom Tool" on page 95](#). Select the corresponding system name.
- ▶ ["Switching on the server" on page 63](#).
- ▶ ["Performing a RAID array rebuild" on page 91](#).

7.5.9 Upgrading to 4x PCIe 2.5-inch SSD configuration



A PCIe backplane can only be installed as the first backplane.



A PCIe SSD backplane needs a PRAID EP5x0i or PRAID EP6x0i, see ["Example PRAID EP5xxi" on page 202](#).



Field Replaceable Unit (FRU)



Hardware: 10 minutes

Tools: Phillips PH2 / (+) No. 2 screw driver



CAUTION

All data on all HDDs in the array will be lost when deleting the RAID array!

- ▶ Be sure to back up your data before deleting a RAID array.
- ▶ For more information, see the "iRMC S6 - Web Interface" user guide.



After installing or removing an additional backplane, never forget to change the system information using the Chassis ID Prom Tool.

Preliminary steps

 The HDD backplane is mounted on the HDD cage. It is not necessary to remove the HDD cage before installing or removing the HDD backplane.

- ▶ ["Shutting down the server" on page 47.](#)
- ▶ ["Disconnecting the power cord" on page 48.](#)
- ▶ Remove all HDD/SSD modules from the server, see ["Removing 2.5-inch HDD/SSD modules" on page 156.](#)
- ▶ ["Getting access to the component" on page 50.](#)
- ▶ Remove all HDD fan modules, see ["Removing the HDD fan module \(2.5-inch HDD variant\)" on page 70.](#)
- ▶ Remove all HDD backplanes, see ["Removing a 2.5-inch HDD/PCIe backplane" on page 162.](#)

Installing the PCIe backplane

- ▶ Install the PCIe backplane, see ["Installing a 2.5-inch HDD/PCIe backplane" on page 163.](#)
- ▶ Connect cables to the PCIe backplane, see ["Connecting cables" on page 165.](#)



For the cable plan, see ["Appendix B" on page 391.](#)



For further informations about connecting SAS cables to the PRAID controller, see ["Installing expansion cards" on page 199.](#)

Concluding steps

- ▶ If applicable, install the HDD backplane as backplane 2.
- ▶ Install all HDD fan modules, see ["Installing the HDD fan module \(2.5-inch HDD variant\)" on page 71.](#)
- ▶ ["Installing 2.5-inch HDD/SSD modules" on page 154.](#)
- ▶ ["Reassembling" on page 56.](#)
- ▶ ["Connecting the power cord" on page 59.](#)

- ▶ Update the system information of your server using the Chassis ID Prom Tool, see ["Using the Chassis ID Prom Tool" on page 95](#). Select the corresponding system name.
- ▶ ["Switching on the server" on page 63](#).
- ▶ ["Performing a RAID array rebuild" on page 91](#).

8 Fans

8.1 Safety notes



CAUTION

- ▶ Do not damage or modify internal cables or devices. Doing so may cause a device failure, fire, or electric shock.
- ▶ Devices and components inside the server remain hot after shutdown. After shutting down the server, wait for hot components to cool down before installing or removing internal options.
- ▶ Circuit boards and soldered parts of internal options are exposed and can be damaged by static electricity. Always discharge static build-up (e.g. by touching a grounded object) before handling electrostatic-sensitive devices (ESDs).
- ▶ Do not touch the circuitry on boards or soldered parts. Hold circuit boards by their metallic areas or edges.
- ▶ If devices are installed or disassembled using methods other than those outlined in this chapter, the warranty will be invalidated.
- ▶ The procedure of installation on this notes might change depending on a configuration of options.
- ▶ For more information, see ["Important information" on page 31](#).

8.2 Basic information



Since the HDD fan module is not redundant, it has to be replaced immediately in case of defects or pre-failure events.

Numbering of the HDD fan modules (3.5-inch HDD variant)

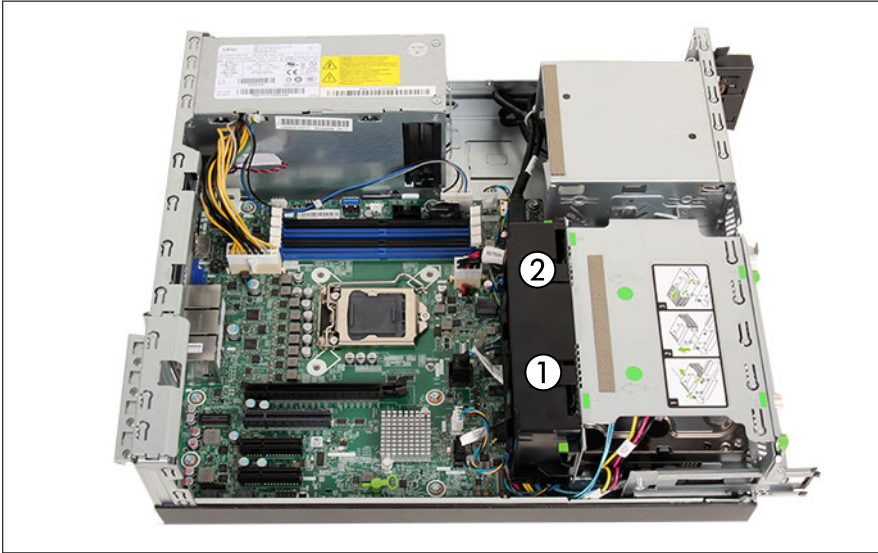

Figure 91: Numbering of the fan modules (3.5-inch HDD variant)

1 Fan 1

2 Fan 2

Numbering of the HDD fan modules (2.5-inch HDD variant)

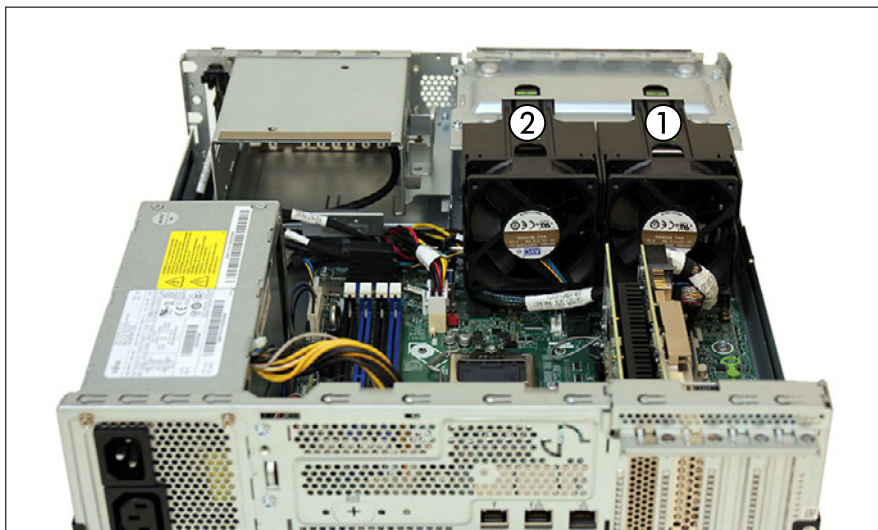

Figure 92: Numbering of the fan modules (2.5-inch HDD variant)

1 Fan 1

2 Fan 2

8.3 Replacing the HDD fan (3.5-inch HDD variant)



Upgrade and Repair Unit
(URU)



Hardware: 10 minutes

Tools: tool-less

Preliminary steps

- ▶ ["Locating the defective server" on page 45.](#)
- ▶ ["Shutting down the server" on page 47.](#)
- ▶ ["Disconnecting the power cord" on page 48.](#)
- ▶ ["Getting access to the component" on page 50.](#)

Fans

- ▶ Remove the HDD fan module, see ["Removing the HDD fan module \(3.5-inch HDD variant\)"](#) on page 67.

Removing the defective HDD fan

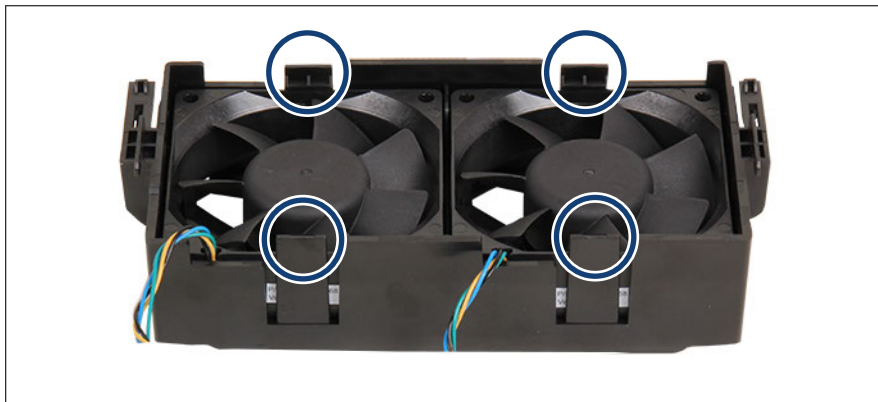

Figure 93: Position of the locking latches

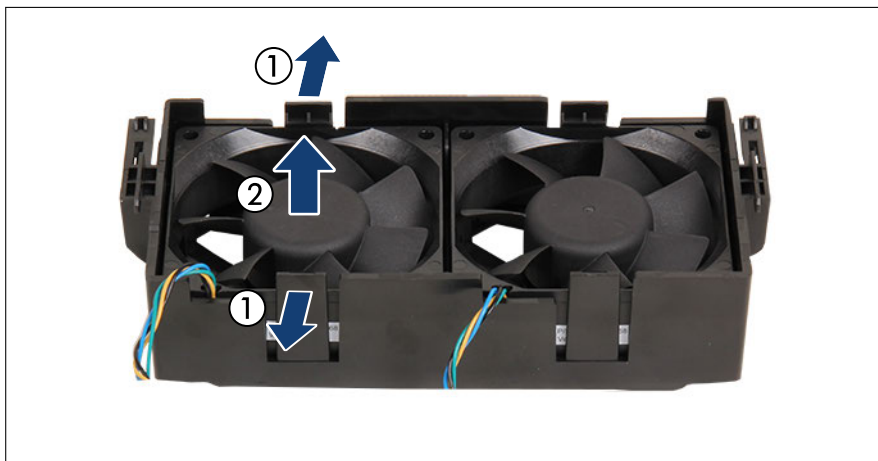

Figure 94: Removing the HDD fan

- ▶ Press outside the two locking latches of the defective HDD fan (1).
- ▶ Remove the HDD fan (2).

Installing the new HDD fan

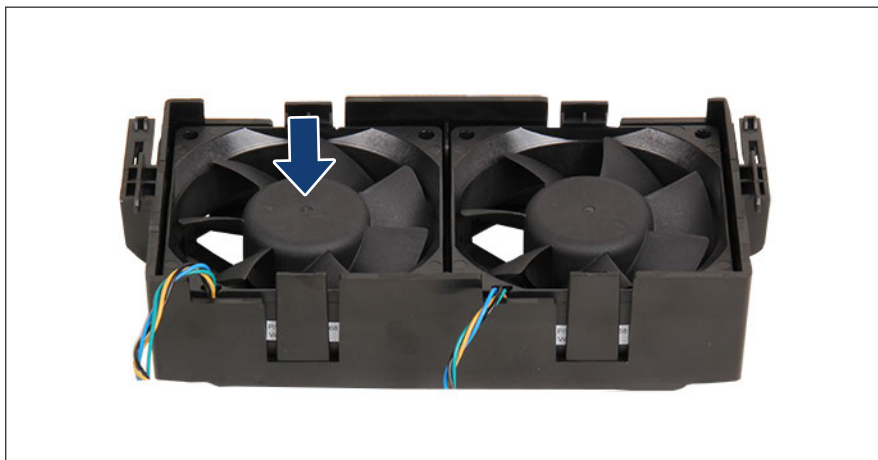

Figure 95: Installing the HDD fan

- ▶ Insert the HDD fan in the fan cage until the locking latches snap in place.
- ▶ Ensure that the fan cable and the fan label are located at the bottom of the HDD fan module.

Concluding steps

- ▶ Install the HDD fan module, see ["Installing the HDD fan module \(3.5-inch HDD variant\)" on page 68](#).
- ▶ ["Reassembling" on page 56](#).
- ▶ ["Connecting the power cord" on page 59](#).
- ▶ ["Switching on the server" on page 63](#).
- ▶ ["Performing a fan test" on page 99](#).

8.4 Replacing the HDD fan (2.5-inch HDD variant)



Upgrade and Repair Unit (URU)



Hardware: 10 minutes

Tools: tool-less

Preliminary steps

- ▶ ["Locating the defective server" on page 45.](#)
- ▶ ["Shutting down the server" on page 47.](#)
- ▶ ["Disconnecting the power cord" on page 48.](#)
- ▶ ["Getting access to the component" on page 50.](#)
- ▶ Remove the HDD fan module, see ["Removing the HDD fan module \(2.5-inch HDD variant\)" on page 70.](#)

Removing the defective HDD fan

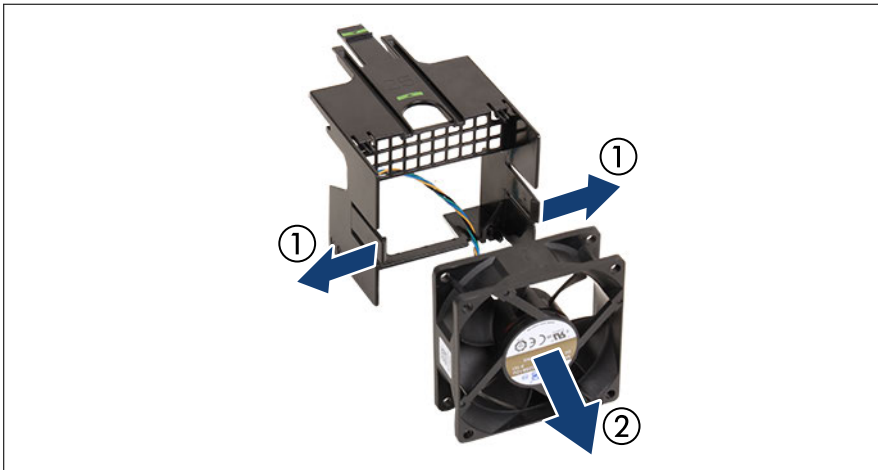

Figure 96: Removing the HDD fan

- ▶ Press outside the two locking latches (1).
- ▶ Remove the HDD fan (2).

Installing the new HDD fan

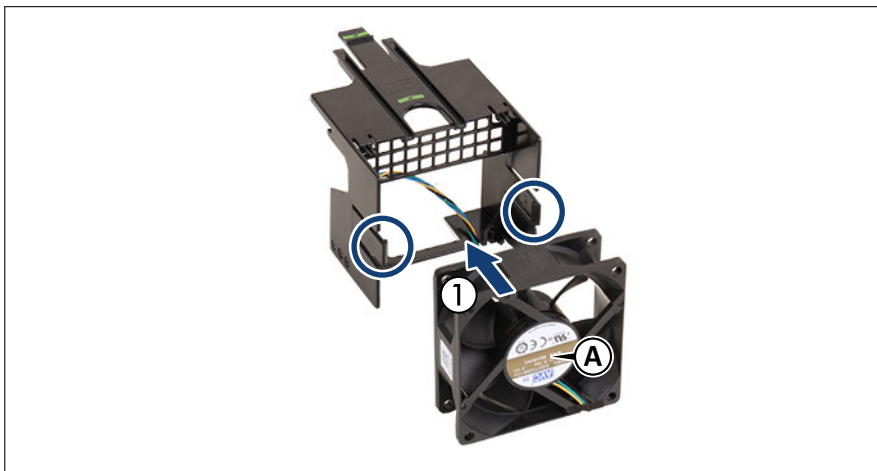

Figure 97: Installing the HDD fan

- ▶ Insert the HDD fan in the fan cage (1) until the locking latches snap in place (see circles).
- ▶ Ensure that the fan label is located outside (A).

Breakout and recess in the HDD fan module

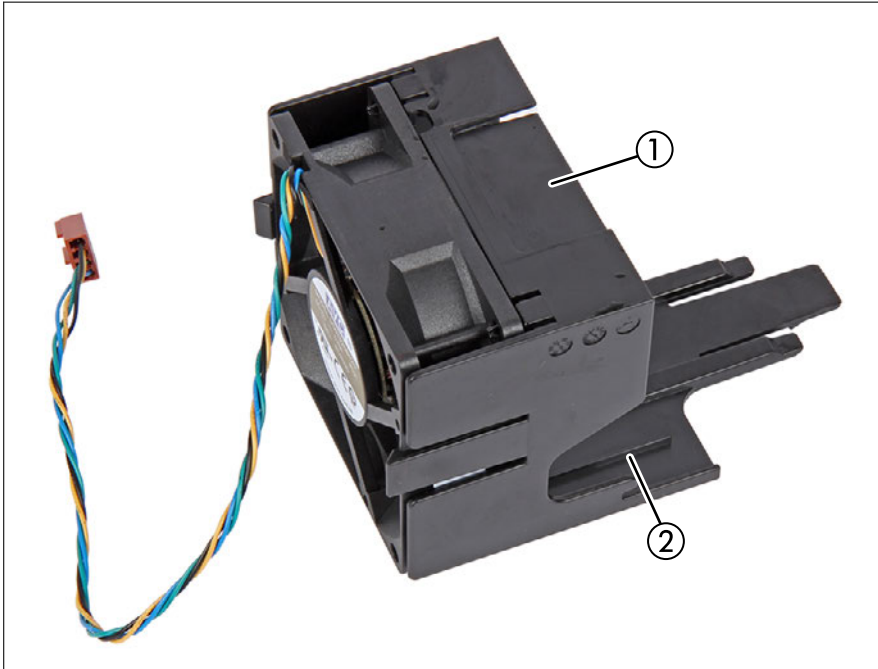

Figure 98: HDD fan module - breakout and recess

- | | | | |
|---|-------------------------------------|---|---|
| 1 | Breakout for the NVMe or SAS cables | 2 | Recess for the power/OOB cable of SAS configuration |
|---|-------------------------------------|---|---|

If using a PCIe backplane or SAS/SATA backplane:

- ▶ Break out the plastic flap of the HDD fan module by hand (1) so that the NVMe or SAS cables can be run through the breakout. This part can be disposed.

Concluding steps

- ▶ Install the HDD fan module, see ["Installing the HDD fan module \(2.5-inch HDD variant\)" on page 71.](#)
- ▶ ["Reassembling" on page 56.](#)
- ▶ ["Connecting the power cord \(standard PSU, with cable tie\)" on page 59.](#)

- ▶ ["Switching on the server" on page 63.](#)
- ▶ ["Performing a fan test" on page 99.](#)

9 Expansion cards and backup units

9.1 Safety notes



CAUTION

- ▶ Do not damage or modify internal cables or devices. Doing so may cause a device failure, fire, or electric shock.
- ▶ Devices and components inside the server remain hot after shutdown. After shutting down the server, wait for hot components to cool down before installing or removing internal options.
- ▶ Circuit boards and soldered parts of internal options are exposed and can be damaged by static electricity. Always discharge static build-up (e.g. by touching a grounded object) before handling electrostatic-sensitive devices (ESDs).
- ▶ Do not touch the circuitry on boards or soldered parts. Hold circuit boards by their metallic areas or edges.
- ▶ If devices are installed or disassembled using methods other than those outlined in this chapter, the warranty will be invalidated.
- ▶ For more information, see "[Important information](#)" on page 31.

9.2 Basic information

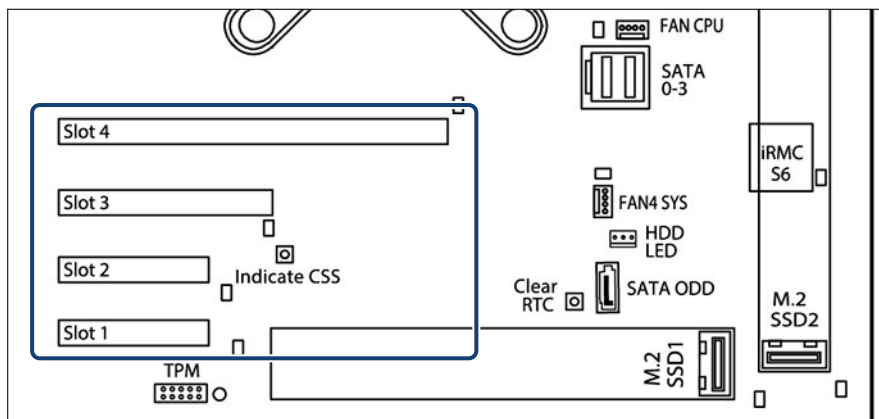

Figure 99: PCIe slot overview

PCIe slot	Type	Length / Form factor	Function
1	PCIe Gen3 x4 (mechanical x4)	167,65 mm /low profile	Slot for optional PCIe expansion cards
2	PCIe Gen3 x4 (mechanical x4)	167,65 mm /low profile	Slot for optional PCIe expansion cards
3	PCIe Gen4 x8 (mechanical x8)	167,65 mm /low profile	Dedicated slot for boot controllers In SAS configuration slot 3 is proposed for modular RAID controller.
4	PCIe Gen4 x8 (mechanical x16)	167,65 mm /low profile	Dedicated slot for PCIe graphics card

Slot configuration	PCIe root setting
Slot 4: x16 Slot 3: empty	1x 16 PCI Express
Slot 4: x16 Slot 3: x8, x4, x1	2x 8 PCI Express
Slot 4: x8, x4, x1 Slot 3: x8, x4, x1	2x 8 PCI Express
Slot 4: empty Slot 3: x8, x4, x1	2x 8 PCI Express
Slot 4: x8, x4, x1 Slot 3: empty	2x 8 PCI Express



For system relevant information, see the hardware configurator of your server available online at the following address: https://ts.fujitsu.com/products/standard_servers/index.html

For Japan:
<https://www.fujitsu.com/jp/products/computing/servers/primergy/>

9.3 Handling slot brackets

9.3.1 Installing slot brackets



Upgrade and Repair Unit (URU)



Hardware: 5 minutes

Tools: Phillips PH2 / (+) No. 2 screw driver



Use the low profile bracket perforated for relevant controllers. No bracket needed for installing the internal RAID controller in the internal RAID riser module.



Figure 100: Perforated and non-perforated slot brackets

- | | | | |
|---|------------------------------------|---|--------------------------------|
| 1 | Full height bracket non-perforated | 3 | Low profile bracket perforated |
| 2 | Full height bracket perforated | | |

Installing a slot bracket

- ▶ Place the controller on the mounting tabs on the slot bracket.
- ▶ Fasten the slot bracket to the controller with two screws.

Example: EP540i

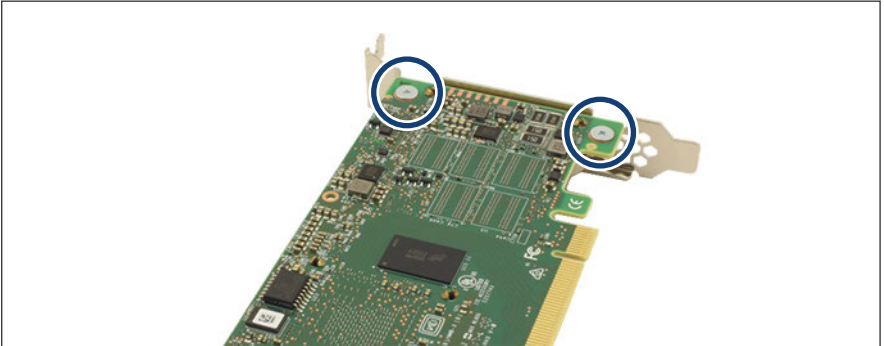

Figure 101: Placing the slot bracket

- ▶ Turn the controller to his bottom side.
- ▶ Place the controller on the slot bracket.
- ▶ Secure the slot bracket to the expansion card with two screws (see circles).

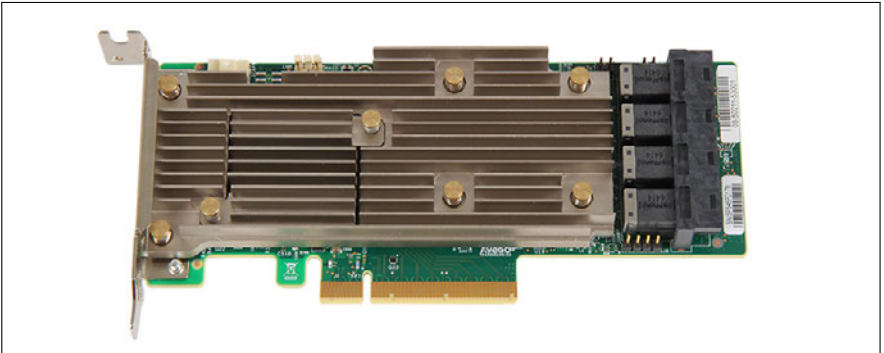

Figure 102: EP540i with installed slot bracket

- ▶ Turn the controller to his top side.

9.3.2 Removing slot brackets



Upgrade and Repair Unit (URU)



Hardware: 5 minutes

Tools: Phillips PH2 / (+) No. 2 screw driver

Removing a slot bracket

- ▶ Remove the two screws.
- ▶ Remove the controller from the mounting tabs on the slot bracket.

9.4 Handling SFP+ transceiver modules

9.4.1 Installing SFP+ transceiver modules



Upgrade and Repair Unit (URU)



Hardware: 5 minutes

Tools: tool-less

The SFP+ transceiver modules are hot-pluggable.

The activation replacement depends on the system configuration. Check it with the customer who is managing the system or the system engineer.

In addition, if the SFP+ transceiver module is independently registered as a spare part, the SFP+ transceiver module can be replaced independently. If the spare part unit consists of an SFP+ transceiver module and an expansion card, replace them in the set.

Installing SFP+ transceiver modules

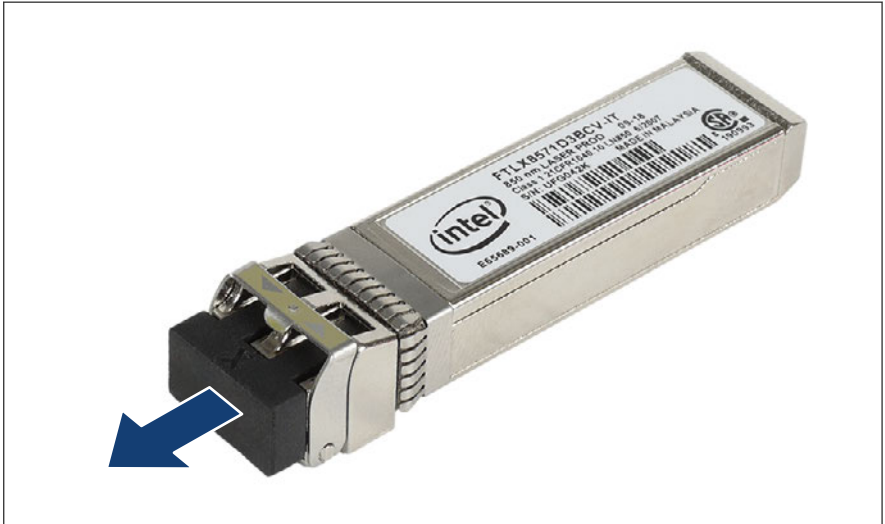

Figure 103: Removing the protective cap

- ▶ Remove the SFP+ transceiver module from its protective packaging.
- ▶ Remove the protective cap from the new/additional SFP+ transceiver module.



CAUTION

- ▶ Always keep the protective caps attached to the SFP+ transceiver modules and fiber-optic cable connectors until you are ready to make a connection.
- ▶ Keep the protective cap for future use.

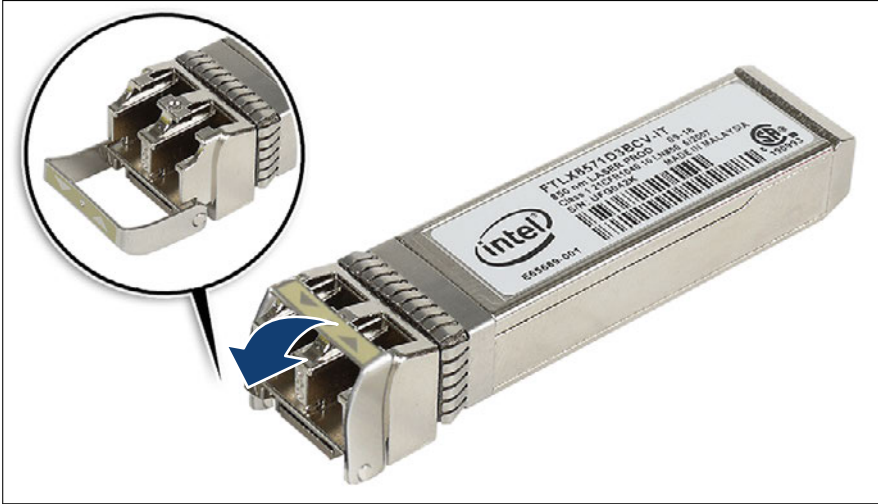

Figure 104: Unlatching the locking bail

- ▶ Carefully unlatch and fold down the locking bail on the SFP+ transceiver module.

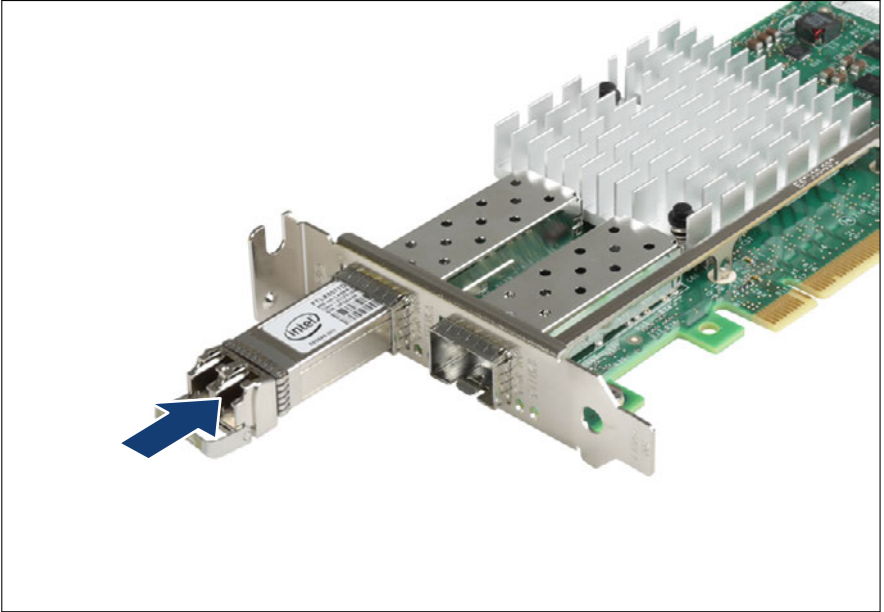

Figure 105: Inserting the SFP+ transceiver module

- ▶ Insert and slide the SFP+ transceiver module into the socket connector as far as it will go.

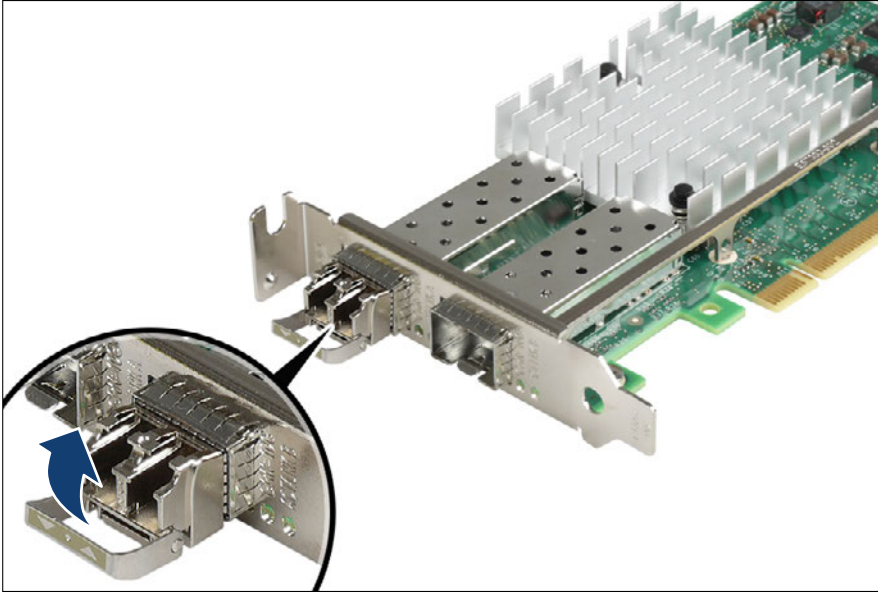

Figure 106: Latching the locking bail

- ▶ Carefully fold up and latch the locking bail.

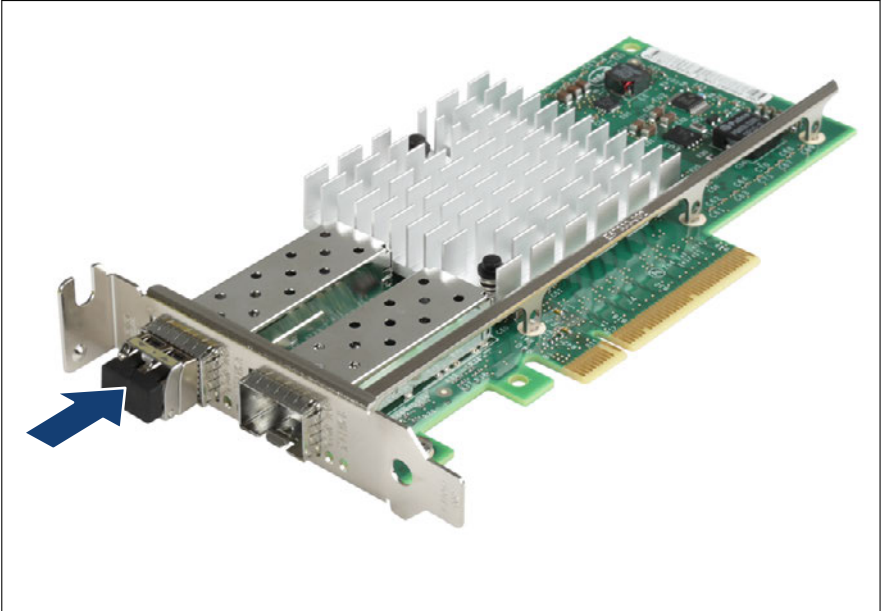

Figure 107: Installing the protective cap

- ▶ If the SFP+ transceiver module is not immediately connected, attach the protective cap to the SFP+ transceiver module.

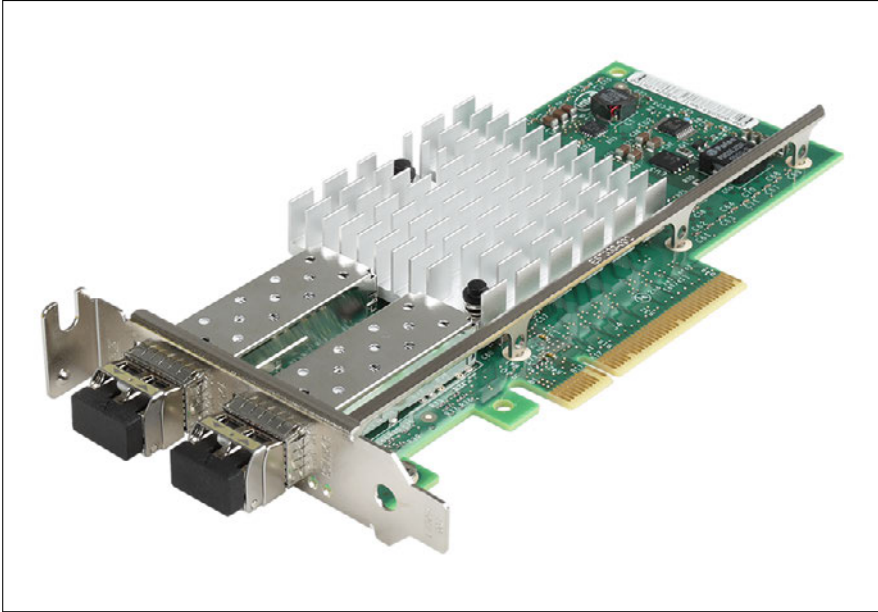

Figure 108: Installing the secondary SFP+ transceiver module

- ▶ If applicable, install the secondary SFP+ transceiver module accordingly.

9.4.2 Removing SFP+ transceiver modules



**Upgrade and Repair Unit
(URU)**



Hardware: 5 minutes

Tools: tool-less

The SFP+ transceiver modules are hot-pluggable.

The activation replacement depends on the system configuration. Check it with the customer who is managing the system or the system engineer.

In addition, if the SFP+ transceiver module is independently registered as a spare part, the SFP+ transceiver module can be replaced independently. If the spare part unit consists of an SFP+ transceiver module and an expansion card, replace them in the set.

Removing an SFP+ transceiver module



Figure 109: Removing the protective cap

- ▶ If present, remove the protective cap from the SFP+ transceiver module.



CAUTION

- ▶ Keep the protective cap for future use.

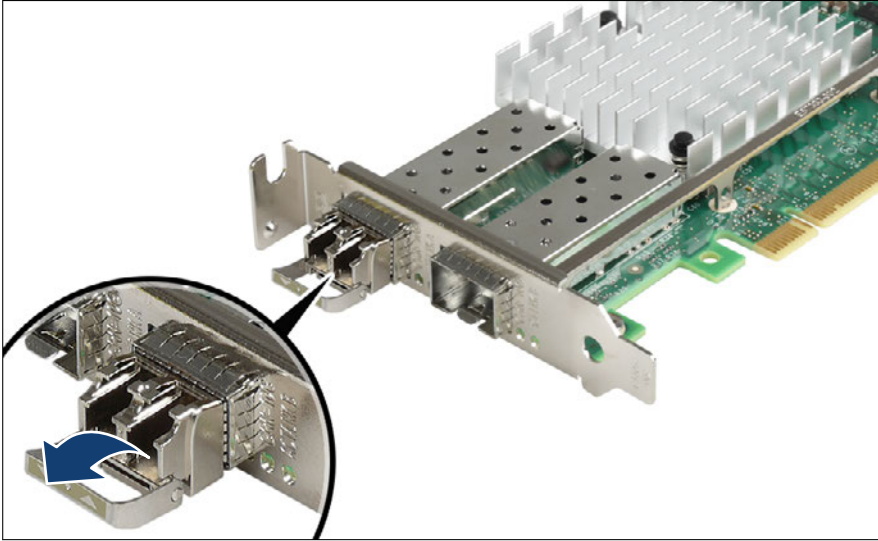

Figure 110: Unlatching the locking bail

- ▶ Carefully unlatch and fold down the locking bail on the SFP+ transceiver module to eject the transceiver from the socket connector.

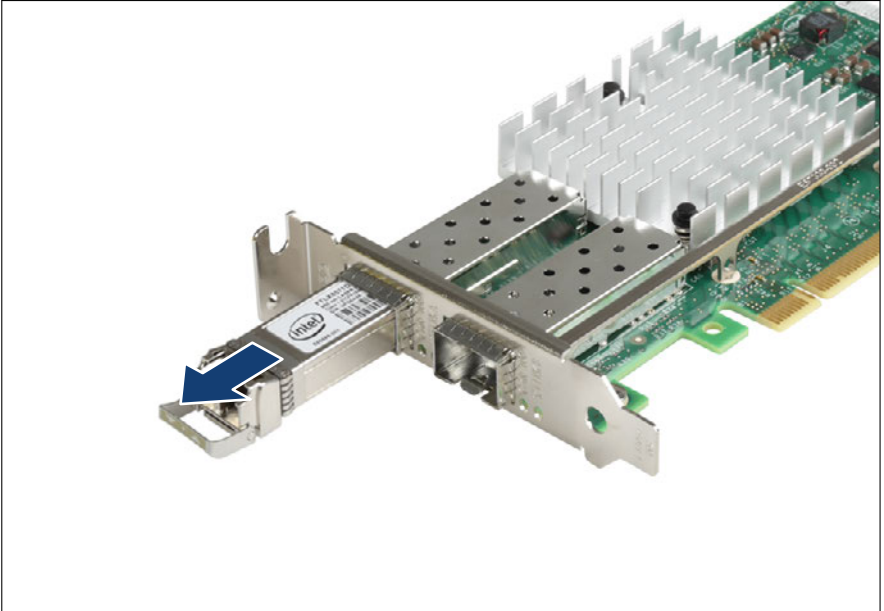

Figure 111: Removing the SFP+ transceiver module

- ▶ Pull the SFP+ transceiver module out of its socket connector.
- ▶ Attach the protective cap to the SFP+ transceiver module.



Place the removed SFP+ transceiver module in an antistatic bag or other protective environment.

9.5 Expansion cards

9.5.1 Installing expansion cards



Upgrade and Repair Unit (URU)



Hardware: 5 minutes
Software: 5 minutes

Tools: Phillips PH2 / (+) No. 2 screw driver (only for installing the slot bracket)

Preliminary steps

- ▶ "Suspending BitLocker functionality" on page 73.
- ▶ "Checking boot priority" on page 77.
- ▶ "Shutting down the server" on page 47.
- ▶ "Disconnecting the power cord" on page 48.
- ▶ "Getting access to the component" on page 50.

Removing a slot cover

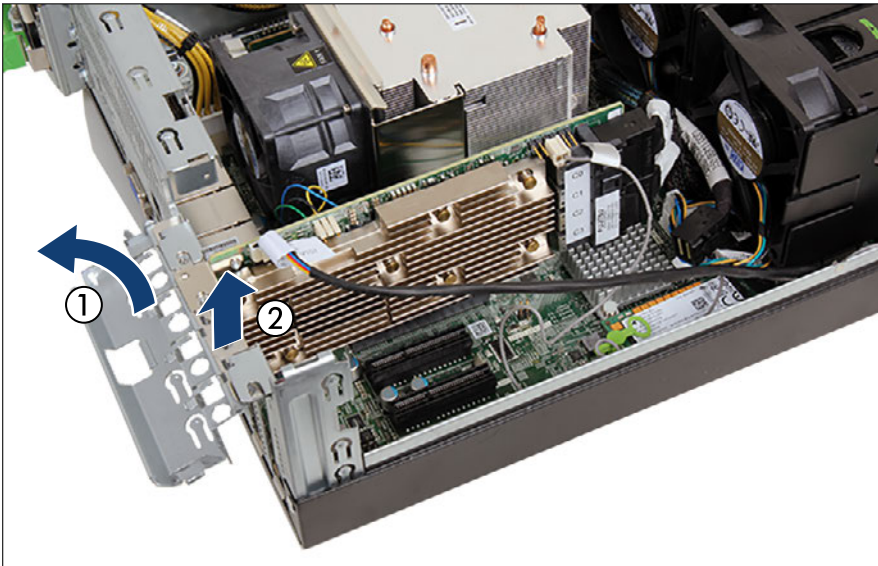

Figure 112: Removing the slot cover

- ▶ Fold up the slot cover clamp (1).
- ▶ Remove the slot cover (2).



CAUTION

- ▶ Keep the slot cover for future use.
- ▶ Always replace slot covers into unused PCI slot openings to comply with applicable EMC regulations and satisfy cooling requirements

Installing the expansion card

- ▶ Remove the expansion card from its protective packaging.



For further instructions regarding controller settings, see the accompanying documentation.

- ▶ If applicable, install the required slot bracket to the expansion card, see ["Installing a slot bracket" on page 188](#).
- ▶ If applicable, connect internal cables to the expansion card.



For the cable plan, see ["Appendix B" on page 391](#).

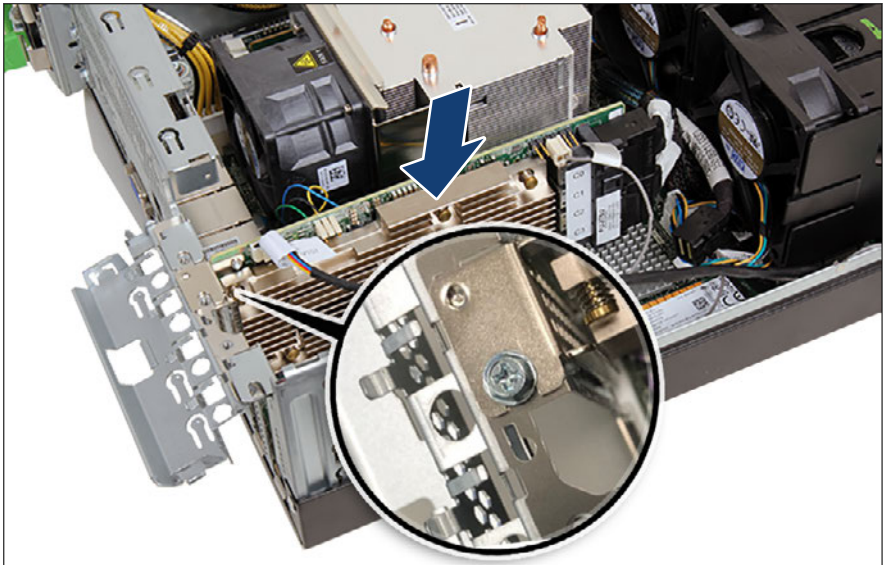

Figure 113: Installing the expansion card

- ▶ Carefully insert the expansion card into the selected PCIe slot and press down firmly until it is fully seated in the slot.
- ▶ If applicable, install an additional screw to fix the expansion card firmly (see close-up).
- ▶ Fold down slot cover clamp until it locks in place.

Expansion cards and backup units

- ▶ If applicable, connect a FBU to the expansion card, see ["Installing an FBU" on page 217](#).

Example PRAID EP5xxi

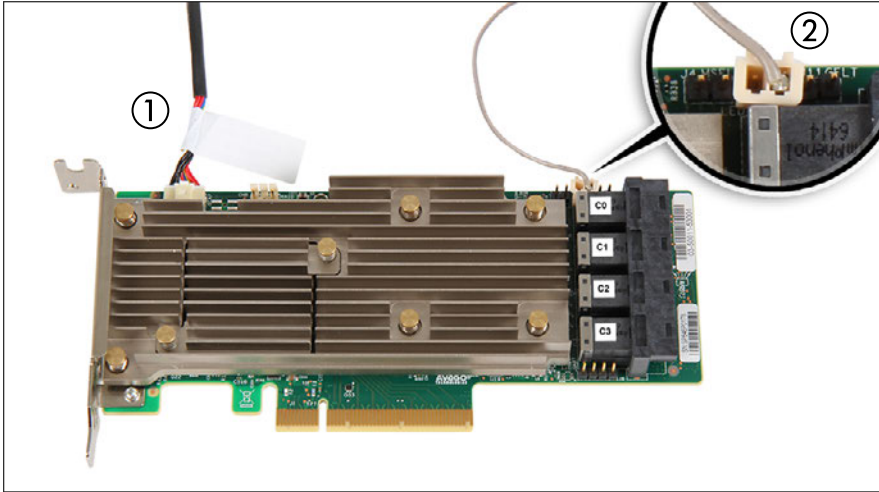

Figure 114: Connecting cables - PRAID EP5xxi

- ▶ Connect the cables:

- 1 If applicable, FBU cable
- 2 HDD LED cable



- ▶ Install the PRAID EP5x0i in slot 3, see ["Installing expansion cards" on page 199](#).

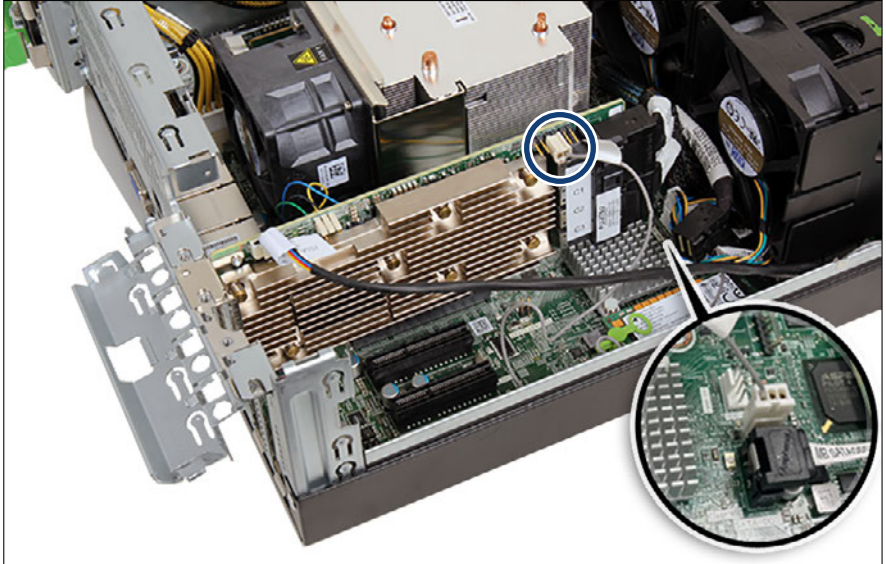

Figure 115: Connecting HDD LED cable

- ▶ Connect the HDD LED cable (see circle) to the connector "HDD LED" on the system board (see close-up).

Expansion cards and backup units

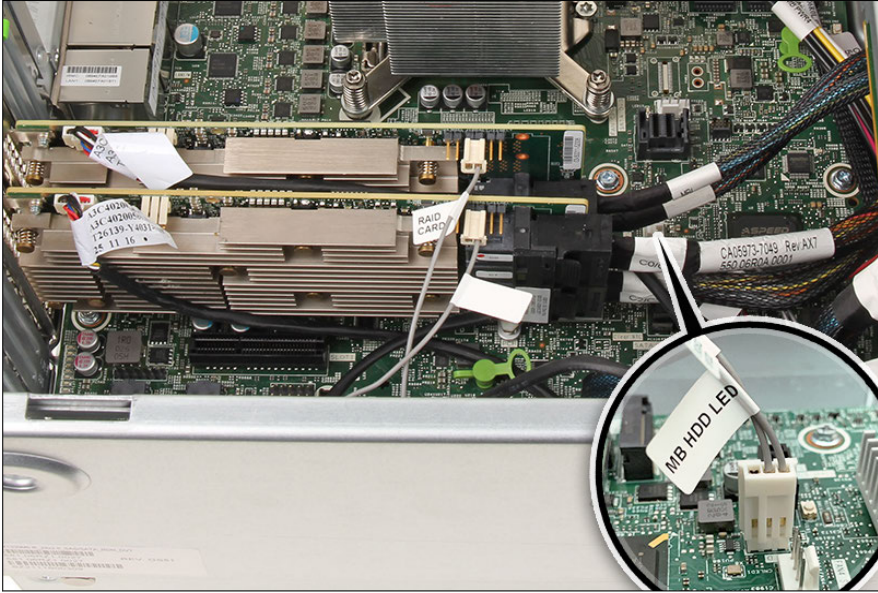

Figure 116: Example with two PRAID EP5x0i

- ▶ With two installed PRAID EP5x0i, connect the HDD LED cable as shown.
- ▶ Connect the SAS cables to the backplane.



For the cable plan, see ["Appendix B" on page 391](#).

Example PRAID EP6x0i

Figure 117: Connecting cables - PRAID EP6x0i

► Connect the cables to the PRAID EP6x0i:

- 1 If applicable, FBU cable
- 2 HDD LED cable

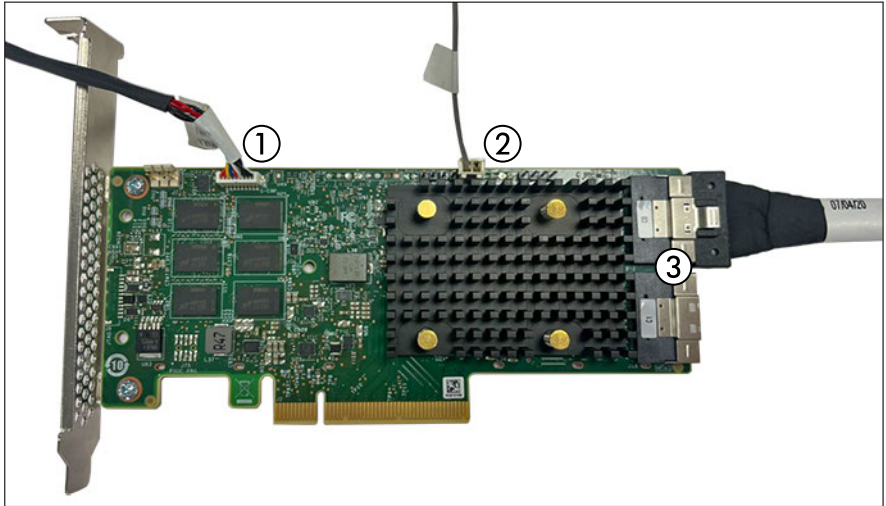
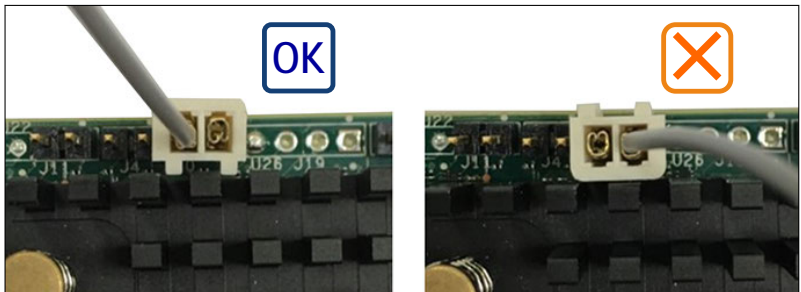

- 3 SAS cables, depending on confi

Example SAS CP5xxi

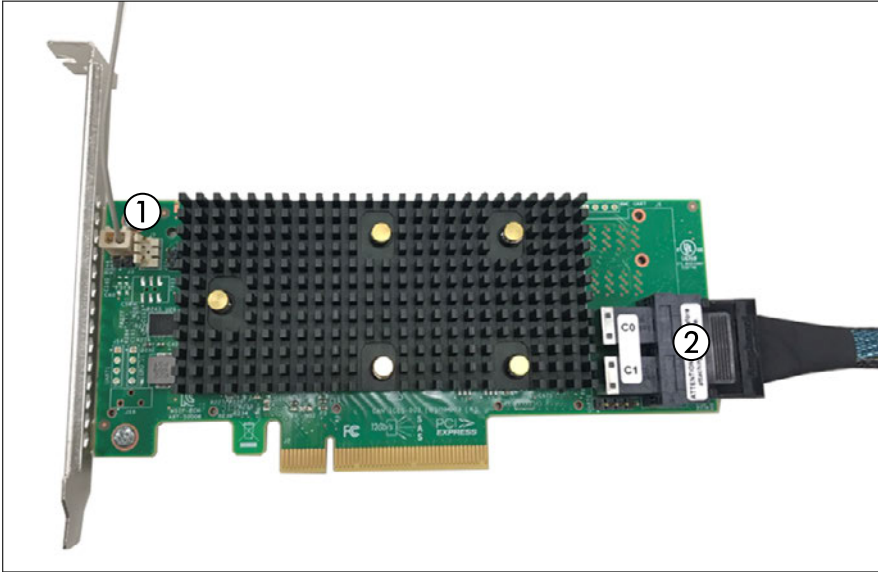
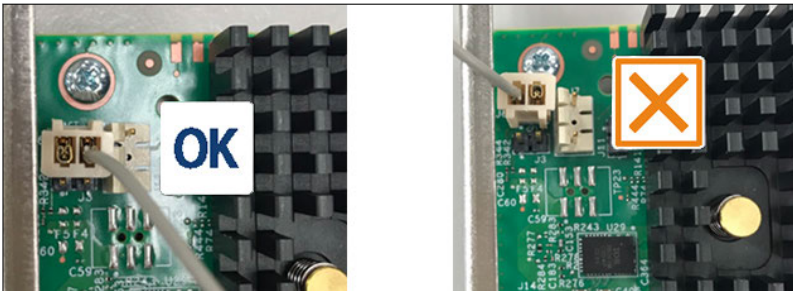

Figure 118: Connecting cables - SAS CP5xxi

► Connect the following cables:

- 1 If applicable, HDD LED cable



- 2 SAS cable

Example SAS CP600i

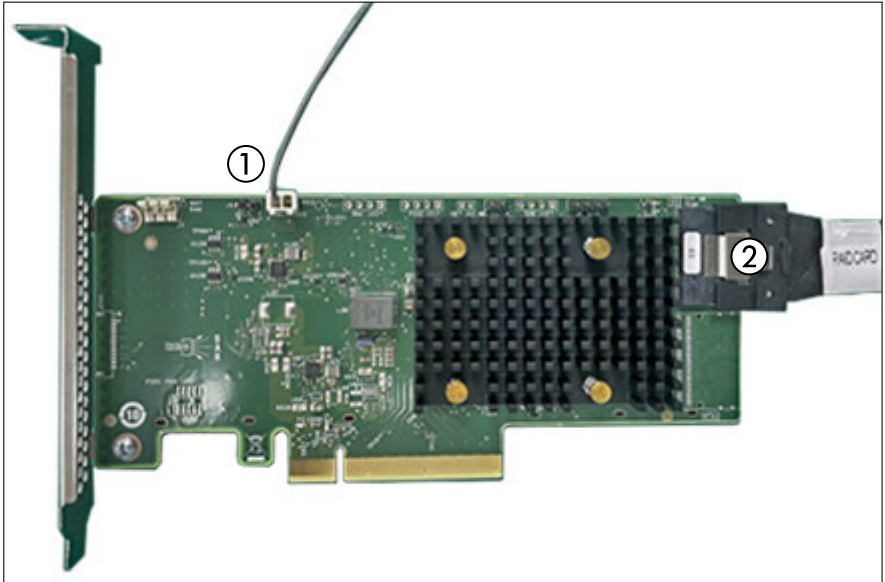
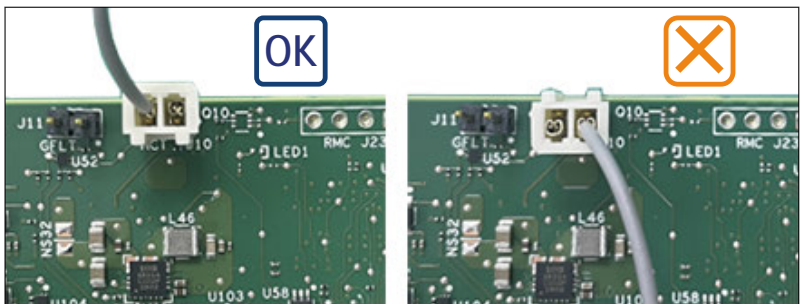

Figure 119: Connecting cables - SAS CP600i

► Connect the following cables:

- 1 HDD LED cable



- 2 SAS cables

Example PRAID EP 3258-16i

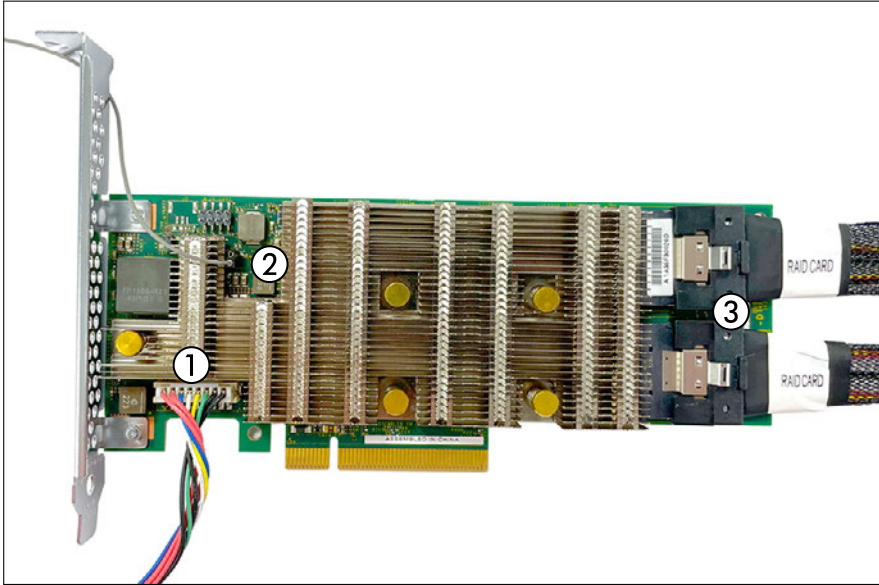
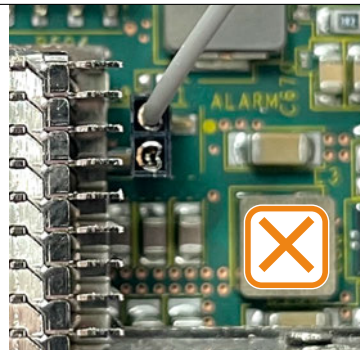

Figure 120: Connecting cables - PRAID EP 3258-16i

► Connect the following cables:

- 1 If applicable, FBU cable
- 2 HDD LED cable



- 3 SAS cables

Example PDUAL CP100 (2x M.2 SSDs SATA RAID PCIe card)

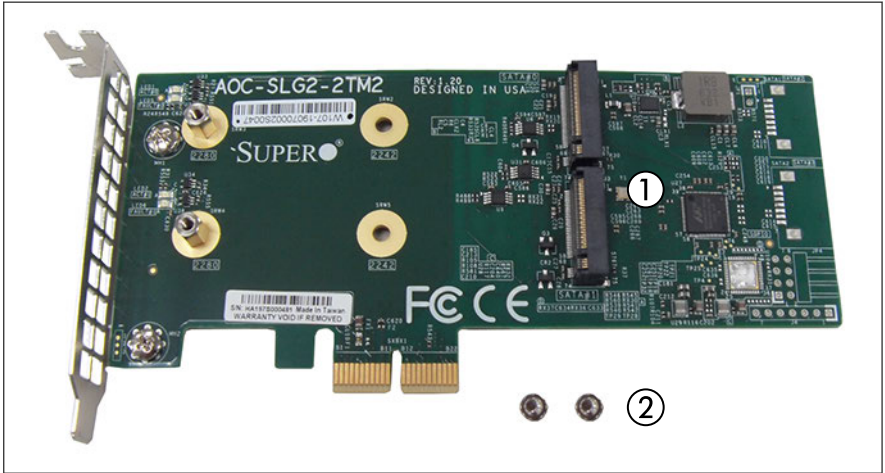

Figure 121: PDUAL CP100

1 PDUAL CP100

2 Screws

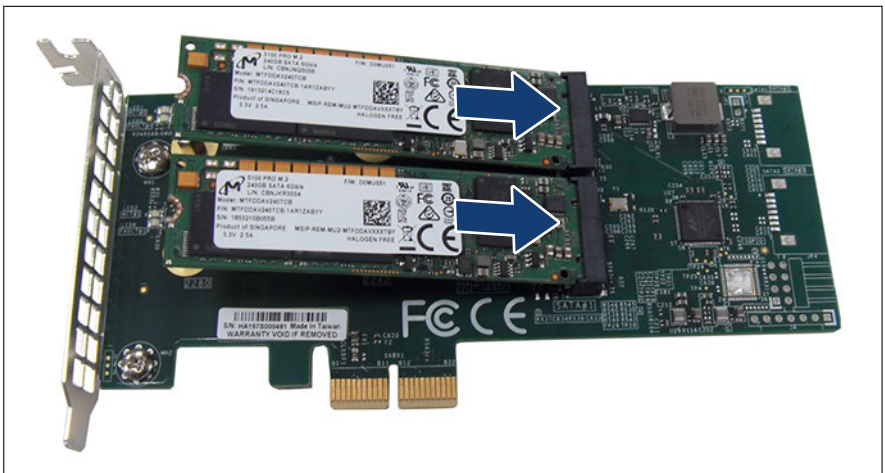

Figure 122: Installing M.2 SSDs (A)

► Insert the two M.2 SDDs in a slight angle.



Figure 123: Installing M.2 SSDs (B)

- ▶ Fasten each M.2 SSD with one screw (see circles).

Concluding steps

- ▶ ["Reassembling" on page 56.](#)
- ▶ If applicable, connect external cables to the expansion card.
- ▶ ["Connecting the power cord" on page 59.](#)
- ▶ ["Switching on the server" on page 63.](#)
- ▶ ["Updating expansion card firmware" on page 81.](#)
- ▶ ["Setting boot priority" on page 100.](#)
- ▶ ["Resuming BitLocker functionality" on page 90.](#)
- ▶ ["After replacing or upgrading LAN controllers" on page 97.](#)

9.5.2 Removing expansion cards



**Upgrade and Repair Unit
(URU)**



Hardware: 5 minutes

Tools: Phillips PH2 / (+) No. 2 screw driver (only for removing the slot bracket)

Preliminary steps

- ▶ ["Suspending BitLocker functionality" on page 73.](#)
- ▶ ["Shutting down the server" on page 47.](#)
- ▶ ["Disconnecting the power cord" on page 48.](#)
- ▶ If applicable, disconnect external cables from the expansion card.
- ▶ ["Getting access to the component" on page 50.](#)

Removing the expansion card

- ▶ If applicable, remove SFP+ transceiver modules from the expansion card, see ["Removing SFP+ transceiver modules" on page 196.](#)
- ▶ If a RAID controller is installed, disconnect the HDD LED cable from the system board.
- ▶ If applicable, disconnect internal cables from the expansion card.
- ▶ If applicable, fold up the slot cover clamp.

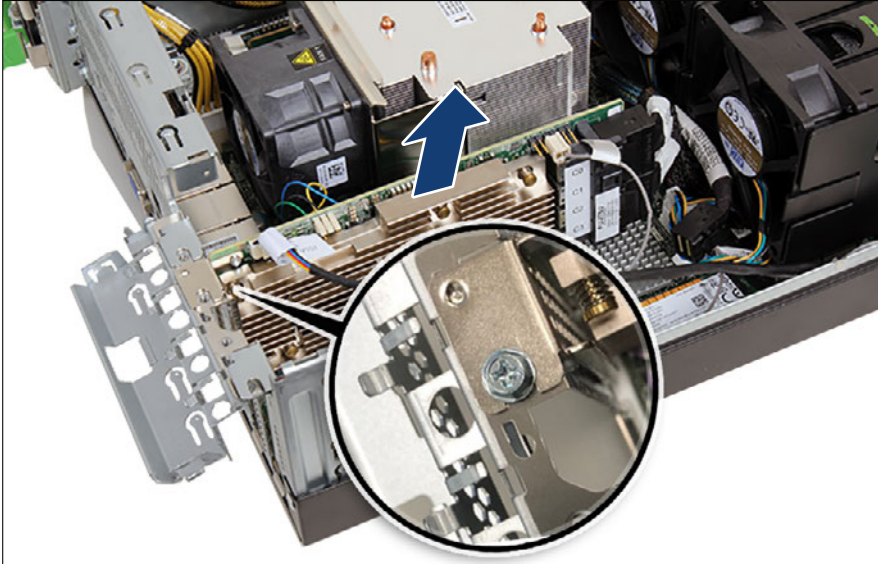

Figure 124: Removing an expansion card

- ▶ If applicable, remove the screw from the slot bracket (see close-up).
- ▶ Carefully remove the expansion card from its slot.

Installing the slot cover



CAUTION

- ▶ Always replace slot covers into unused PCI slot openings to comply with applicable EMC regulations and satisfy cooling requirements.

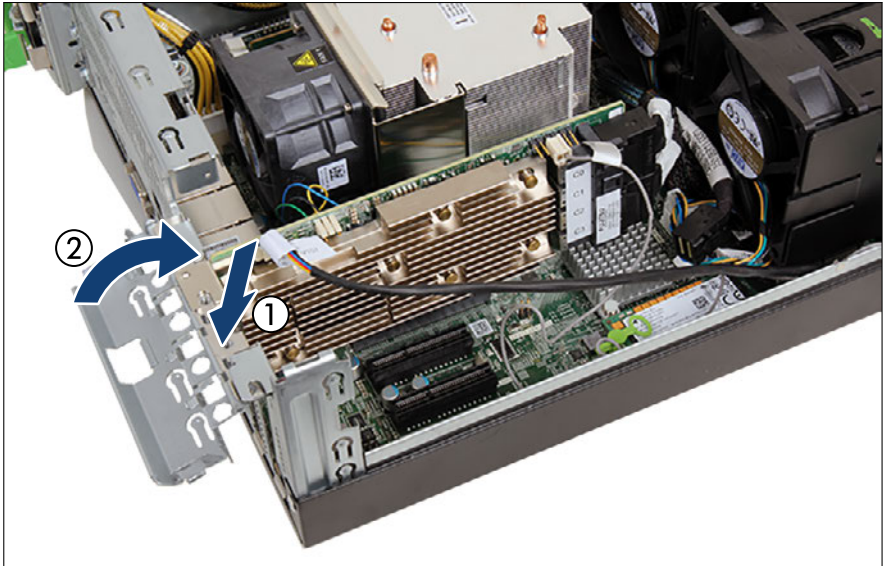

Figure 125: Installing a slot cover

- ▶ If applicable, install a slot cover into the unused PCIe slot opening (1).
- ▶ Fold down the slot cover clamp until it locks in place (2).

Concluding steps

- ▶ "Reassembling" on page 56.
- ▶ "Connecting the power cord" on page 59.
- ▶ "Switching on the server" on page 63.
- ▶ "Removing slot brackets" on page 190.
- ▶ "Removing slot brackets" on page 190.

9.5.3 Replacing expansion cards



**Upgrade and Repair Unit
(URU)**



**Hardware: 5 minutes
Software: 5 minutes**

Expansion cards and backup units

Tools: Phillips PH2 / (+) No. 2 screw driver (only for replacing the slot bracket)

Note on network settings recovery



When replacing network controllers or the system board, network configuration settings in the OS will be lost and replaced by default values. This applies to all static IP address and LAN teaming configurations.

Ensure to note down your current network settings before replacing a network controller or the system board.

Preliminary steps

- ▶ ["Locating the defective server" on page 45.](#)
- ▶ ["Suspending BitLocker functionality" on page 73.](#)
- ▶ ["Checking boot priority" on page 77.](#)
- ▶ If applicable, ensure to note down your current network settings.
- ▶ ["Shutting down the server" on page 47.](#)
- ▶ ["Disconnecting the power cord" on page 48.](#)
- ▶ If applicable, disconnect external cables from the expansion card.
- ▶ ["Getting access to the component" on page 50.](#)
- ▶ ["Locating the defective component" on page 46.](#)

Removing an expansion card

- ▶ Remove the expansion card, see ["Removing the expansion card" on page 211.](#)
- ▶ If the slot bracket on the defective expansion card is to be reused, remove it from the expansion card, see ["Removing slot brackets" on page 190.](#)

Installing an expansion card

- ▶ If applicable, install the slot bracket, see ["Installing a slot bracket" on page 188](#).
- ▶ Install the expansion card, see ["Installing the expansion card" on page 201](#).

Concluding steps

- ▶ ["Reassembling" on page 56](#).
- ▶ If applicable, connect external cables to the expansion card.
- ▶ ["Connecting the power cord" on page 59](#).
- ▶ ["Switching on the server" on page 63](#).
- ▶ ["Enabling replaced components in the BIOS" on page 86](#).
- ▶ Inform the customer about changed WWN and MAC addresses, see ["Looking for MAC/WWN/GUID and SAS addresses" on page 92](#).
- ▶ After replacing a network controller in a server running Linux OS, see ["Updating the NIC configuration file in a Linux and VMware environment" on page 89](#).
- ▶ ["Updating expansion card firmware" on page 81](#).
- ▶ ["Setting boot priority" on page 100](#).
- ▶ ["Resuming BitLocker functionality" on page 90](#).
- ▶ If applicable, reconfigure your network settings in the operation system according to the original configuration of the replaced controller (expansion card or onboard).
 -  Configuration of network settings should be performed by the customer. For more information, see ["Note on network settings recovery" on page 214](#).
- ▶ If applicable, restore LAN teaming configurations, see ["After replacing or upgrading LAN controllers" on page 97](#).

9.6 Flash backup unit (FBU)

9.6.1 Position of the FBU

The FBU backs up the memory contents of the RAID controller in the event of a power failure. One FBU can be installed in the system.



Depending on the RAID controller, different FBUs are available. In configurations with PRAID EP5x0i/EP6x0i, an FBU345 is required.



Figure 126: Position of the FBU

- 1 FBU

9.6.2 Installing an FBU



Upgrade and Repair Unit (URU)



Hardware: 5 minutes

Tools: tool-less

Preliminary steps

- ▶ "Shutting down the server" on page 47.
- ▶ "Disconnecting the power cord" on page 48.
- ▶ "Getting access to the component" on page 50.
- ▶ "Disconnecting the front USB connector" on page 287.

Note for different types of FBU

There are different types of FBU, the procedure is identical.



Figure 127: FBU type 1

Expansion cards and backup units

- ▶ Connect the FBU adapter cable (1) to the FBU cable (2).

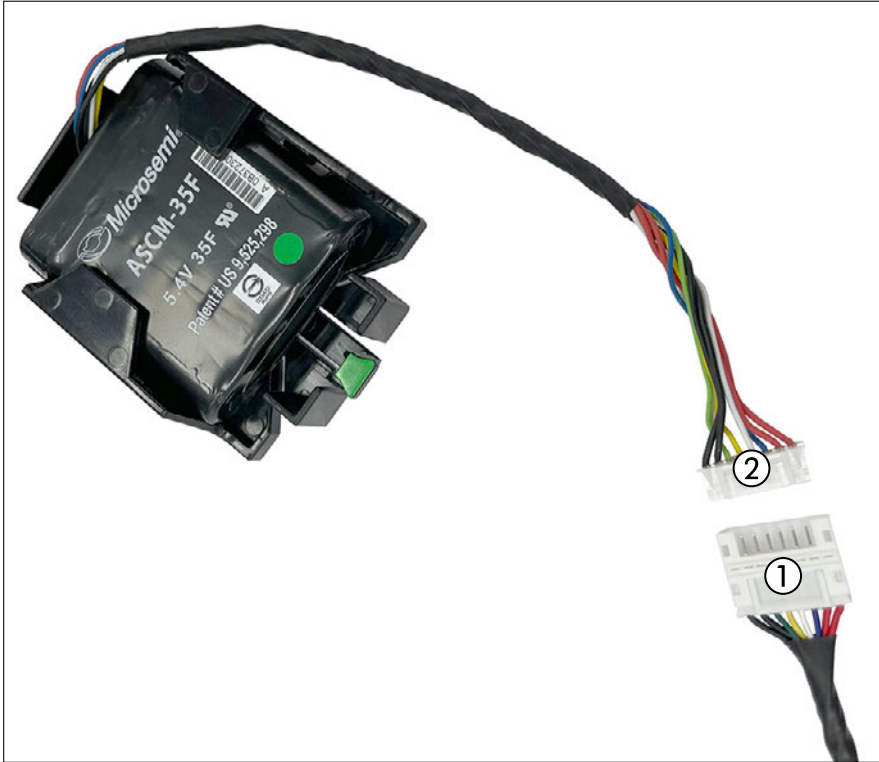

Figure 128: FBU type 2

- ▶ Depending of the configuration, connect the FBU extension cable (1) to the FBU cable (2).

Preparing the FBU



Figure 129: Installing the FBU in the holder

- ▶ Install the FBU in the FBU holder.
- ▶ At a slight angle, align the FBU under the both retaining brackets of the FBU holder.
- ▶ Push in the FBU until it locks in place.
- ▶ Ensure that the FBU is properly seated in the FBU holder.
- ▶ Connect the FBU to the FBU adapter cable.

Removing the FBU tray

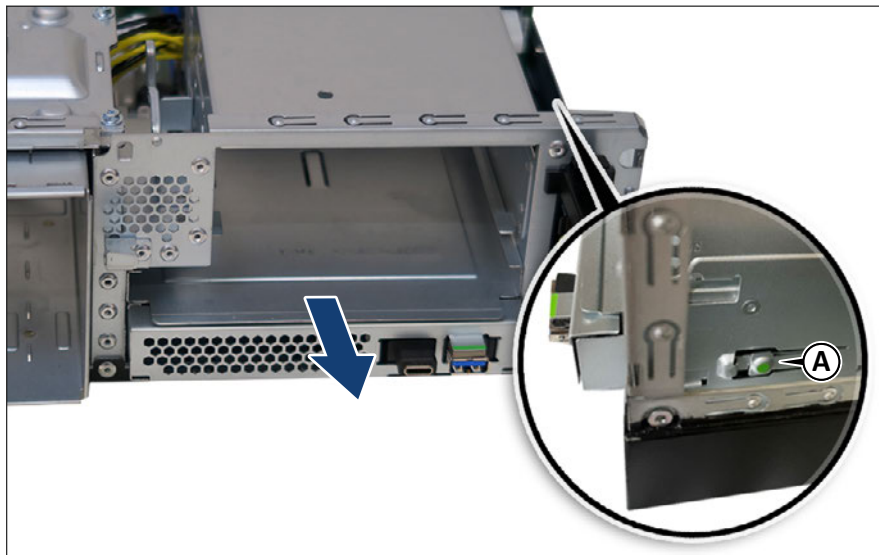

Figure 130: Removing the FBU tray

- ▶ Press on the green tab (A) to open the FBU tray.
- ▶ Pull out the FBU tray.

Installing the FBU module into the FBU tray



Figure 131: Hooks on the FBU tray

- Place the FBU module on the hooks of the FBU tray (see circles).

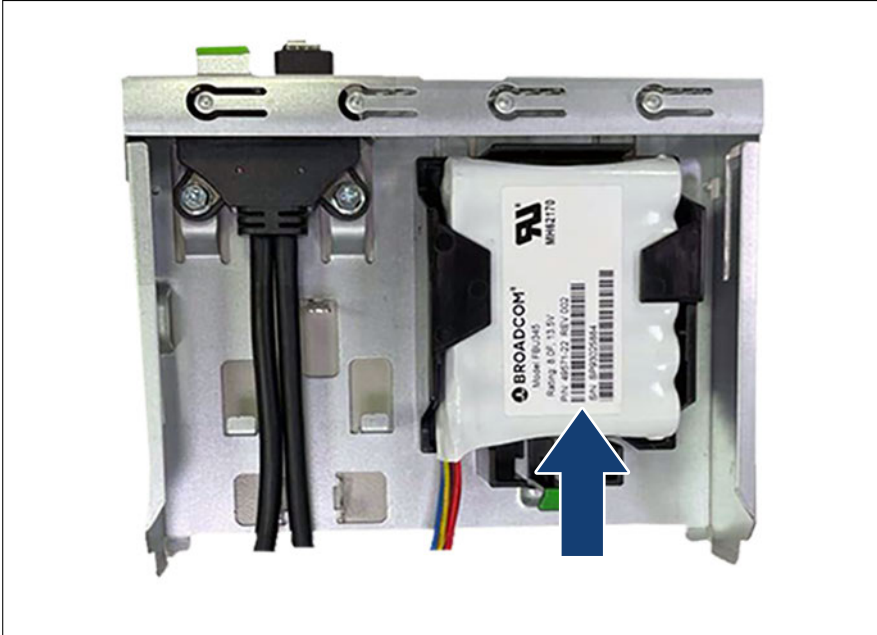

Figure 132: Installing the FBU module

- ▶ Slide in the FBU module until it looks in place.

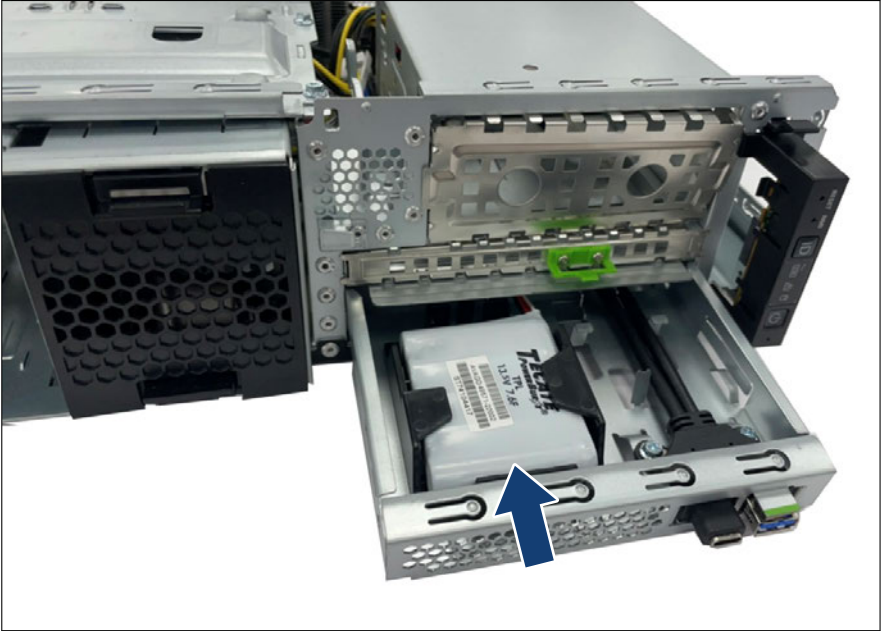

Figure 133: Installing the FBU tray

- ▶ Run the FBU cable through the opening.
- ▶ Install the FBU tray in the bay and slide in as far as it will go.

Connecting the FBU

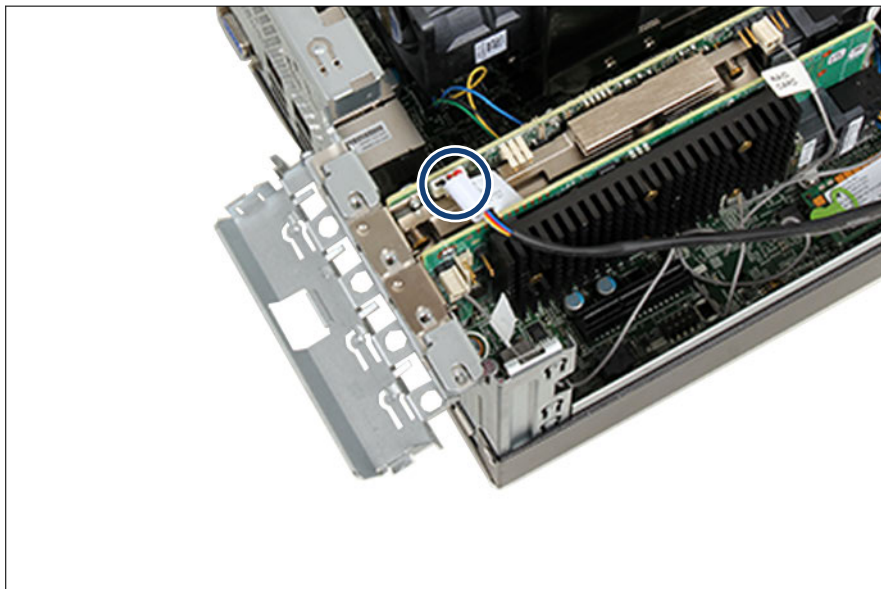

Figure 134: Connecting the FBU cable

- ▶ Connect the FBU cable to the RAID controller (see circle).

Concluding steps

- ▶ ["Connecting the front USB connector" on page 286.](#)
- ▶ ["Reassembling" on page 56.](#)
- ▶ ["Connecting the power cord" on page 59.](#)
- ▶ ["Switching on the server" on page 63.](#)
- ▶ ["Updating expansion card firmware" on page 81.](#)

9.6.3 Removing an FBU



Upgrade and Repair Unit (URU)



Hardware: 5 minutes

Tools: tool-less



CAUTION

- ▶ Dispose of used battery properly. Keep away from children.
- ▶ Do not throw flash backup units into the trash can. Batteries must be disposed of in accordance with local regulations concerning special waste.

Preliminary steps

- ▶ ["Shutting down the server" on page 47.](#)
- ▶ ["Disconnecting the power cord" on page 48.](#)
- ▶ ["Getting access to the component" on page 50.](#)
- ▶ ["Disconnecting the front USB connector" on page 287.](#)

Disconnecting the FBU

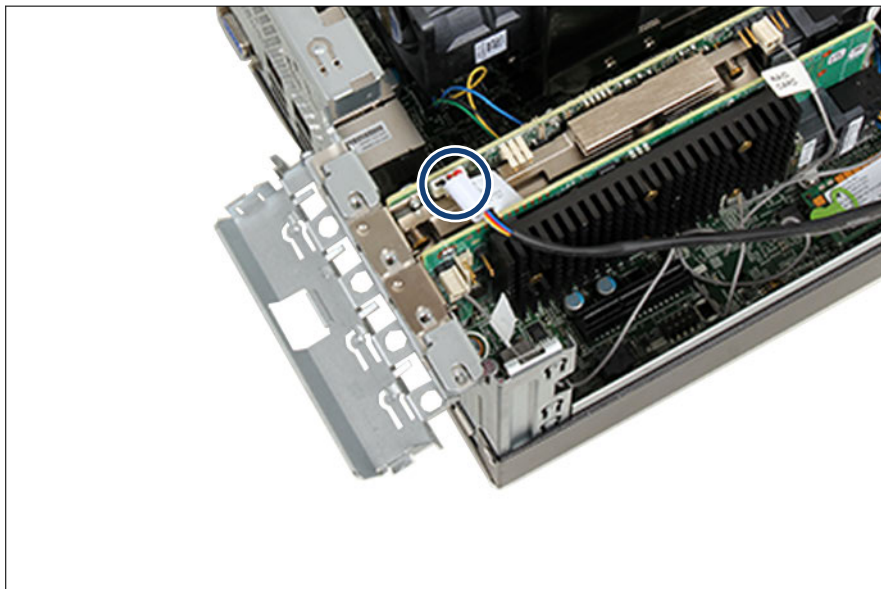

Figure 135: Disconnecting the FBU cable

- ▶ Disconnect the FBU cable from the RAID controller (see circle).

Removing the FBU from the tray

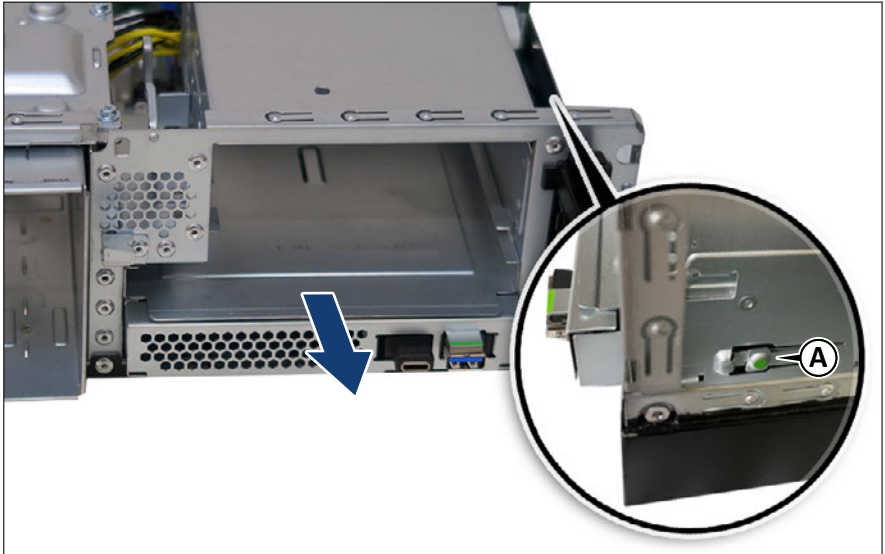

Figure 136: Removing the FBU tray

- ▶ Press on the green tab (see close-up, A) to open the FBU tray.
- ▶ Pull out the FBU tray.

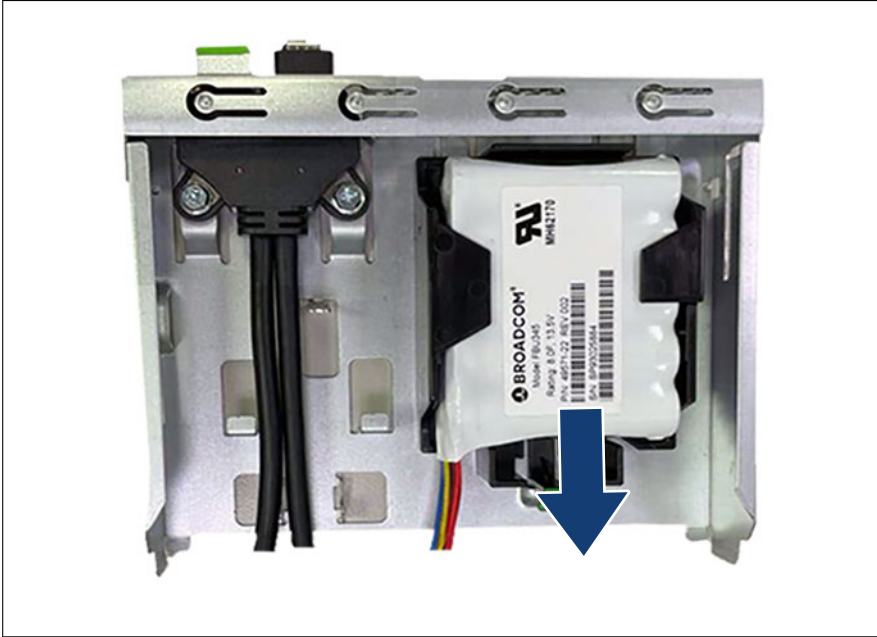

Figure 137: Removing the FBU

- ▶ Slide the FBU in the direction of the arrow and remove the FBU from the FBU tray.
- ▶ Disconnect the FBU from the FBU adapter cable.

Installing the FBU tray



Figure 138: Installing the FBU tray

- ▶ Install the FBU tray into the bay and slide it into the bay as far as it will go.

Concluding steps

- ▶ ["Connecting the front USB connector" on page 286.](#)
- ▶ ["Reassembling" on page 56.](#)
- ▶ ["Connecting the power cord" on page 59.](#)
- ▶ ["Switching on the server" on page 63.](#)

9.6.4 Replacing an FBU



Upgrade and Repair Unit (URU)



Hardware: 10 minutes

Tools: tool-less



CAUTION

- ▶ Dispose of used battery properly. Keep away from children.
- ▶ Do not throw flash backup units into the trash can. Batteries must be disposed of in accordance with local regulations concerning special waste.

Preliminary steps

- ▶ ["Locating the defective server" on page 45.](#)
- ▶ ["Shutting down the server" on page 47.](#)
- ▶ ["Disconnecting the power cord" on page 48.](#)
- ▶ ["Getting access to the component" on page 50.](#)
- ▶ ["Disconnecting the front USB connector" on page 287.](#)

Removing the defective FBU

- ▶ Disconnect the FBU, see ["Disconnecting the FBU" on page 226.](#)
- ▶ Remove the FBU from the FBU tray, see ["Removing the FBU tray" on page 220.](#)

Installing the new FBU

- ▶ Install the FBU into the FBU tray, see ["Installing the FBU tray" on page 229.](#)
- ▶ Connect the FBU, see ["Connecting the FBU" on page 224.](#)

Concluding steps

- ▶ ["Connecting the front USB connector" on page 286.](#)
- ▶ ["Reassembling" on page 56.](#)
- ▶ ["Connecting the power cord" on page 59.](#)
- ▶ ["Switching on the server" on page 63.](#)
- ▶ ["Updating expansion card firmware" on page 81.](#)

10 Main memory

10.1 Safety notes



CAUTION

- ▶ Before removing several memory modules, make sure that all memory modules can be reinstalled into their original slots. Otherwise, data may be lost.
- ▶ Do not install unsupported third party memory modules. For more information on supported memory modules, see "[Basic information](#)" on page 21. Doing so may cause electric shock, a fire, or failures.
- ▶ Memory modules remain hot after shutdown. Wait for components to cool down before installing or removing memory modules to prevent burns.
- ▶ Do not install and remove memory modules repeatedly. Doing so may cause failures.
- ▶ If the memory module has not been correctly installed, it may cause a fire. Install the memory module with attention.

Pressing out the securing clips on the memory module connector will eject the installed memory module. To prevent damage and injuries eject memory modules carefully without applying excessive force.
- ▶ For more information, see "[Important information](#)" on page 31.

10.2 Basic information

10.2.1 Slots and features

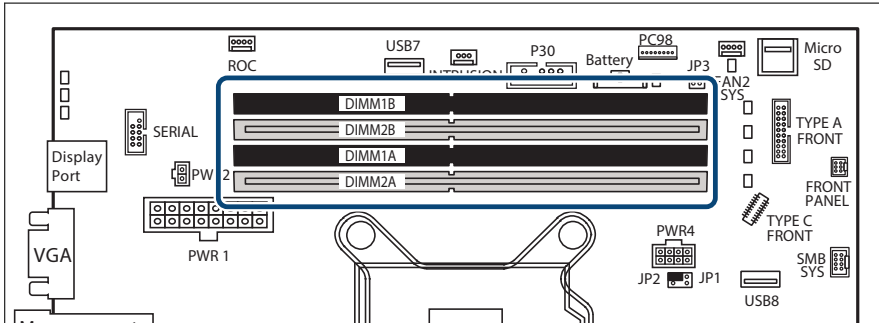

Figure 139: Memory slots overview

- Dual DDR4 memory architecture
- Four memory DIMM sockets
- Up to four DDR4 UDIMMs with up to 128 GB

The notation of the CPU, memory channels and DIMM sockets correspond to the silk print on the system board.

i For system relevant information, see the hardware configurator of your server available online at the following address:

<https://www.fujitsu.com/emeia/products/computing/servers>

For Japan:

<https://www.fujitsu.com/jp/products/computing/servers/primergy/>

10.2.2 General memory population rules

- Populate memory slot 1 / channel A (DIMM 1A) first.
- Within all channels memory slot 1 must be populated prior to slot 2.
- For maximum performance, populate both channels with the same amount of memory (symmetric dual channel configuration).

- Mixing memory modules with different speeds is not supported.
- Mixing memory modules with different technologies or capacities between two channels is not supported.
- Mixing memory modules with different part numbers is not supported.

Channel	A		B	
	1A	2A	1B	2B
DIMM# 1	x			
DIMM# 2	x		x	
DIMM# 3	x	x	x	
DIMM# 4	x	x	x	x

Table 3: Mounting order

10.2.3 Modes of operation

- The maximum performance can be achieved in a symmetric dual-channel configuration. Therefore both channels have to be populated with the same amount of memory. The DRAM device technology (1 Gbit / 2 Gbit / 4 Gbit) may vary from one channel to the other.
- If the amount of memory differs between the two channels, the system board will run in dual-channel asymmetric mode.
- Regardless of the mode, all DIMMs will run at the highest common frequency that is allowed by the SPD Data of the DIMMs and the maximum speed of the selected configuration.
- Single-channel mode is used if one memory module is populated in DIMM 1A.

10.3 Installing memory modules



Upgrade and Repair Unit (URU)



Hardware: 5 minutes

Main memory

Tools: tool-less

Preliminary steps

- ▶ ["Suspending BitLocker functionality"](#) on page 73.
- ▶ ["Shutting down the server"](#) on page 47.
- ▶ ["Disconnecting the power cord"](#) on page 48.
- ▶ ["Getting access to the component"](#) on page 50.

Selecting the memory slot

- ▶ Choose the memory slot according to the configuration rules in ["Basic information"](#) on page 232.

Installing a memory module

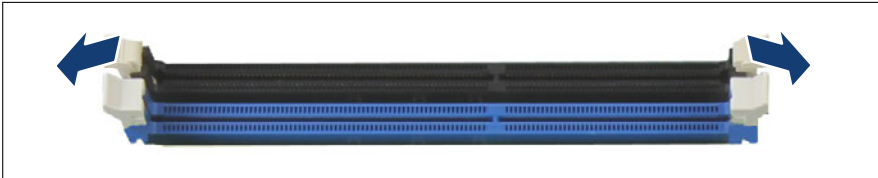

Figure 140: Opening the securing clips

- ▶ Press the securing clips on both sides of the memory slot concerned outward.

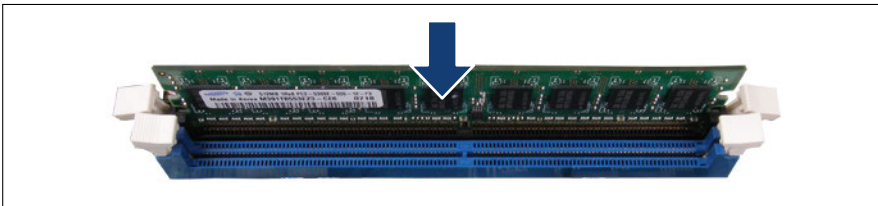

Figure 141: Installing a memory module

- ▶ Align the notch on the bottom of the module with the crossbar in the slot.
- ▶ Press down on the memory module until the securing clips snap into the cutouts at each end of the module.

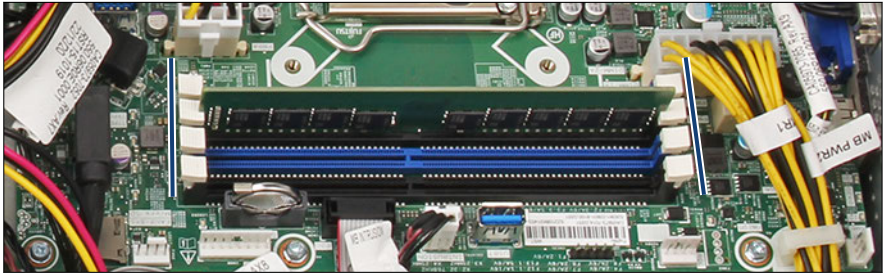

Figure 142: Correct position of securing clips

i To improve the contact of the memory module perform the following steps:

- ▶ Eject the memory module again by pressing out the securing clips at each end of the memory slot.
- ▶ Press down on the memory module until the securing clips snap into the cutouts at each end of the module.
- ▶ Check if all securing clips are in the correct position, see ["Correct position of securing clips" on page 235](#).

Concluding steps

- ▶ ["Reassembling" on page 56](#).
- ▶ ["Connecting the power cord" on page 59](#).
- ▶ ["Switching on the server" on page 63](#).
- ▶ ["Resuming BitLocker functionality" on page 90](#).

10.4 Removing memory modules



Upgrade and Repair Unit
(URU)



Hardware: 5 minutes

Tools: tool-less

Preliminary steps

- ▶ ["Suspending BitLocker functionality"](#) on page 73.
- ▶ ["Shutting down the server"](#) on page 47.
- ▶ ["Disconnecting the power cord"](#) on page 48.
- ▶ ["Getting access to the component"](#) on page 50.

Removing a memory module

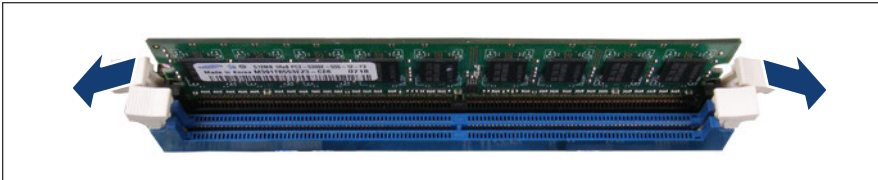

Figure 143: Removing memory modules (A)

- ▶ Eject the desired memory module by pressing out the securing clips at each end of the memory slot.

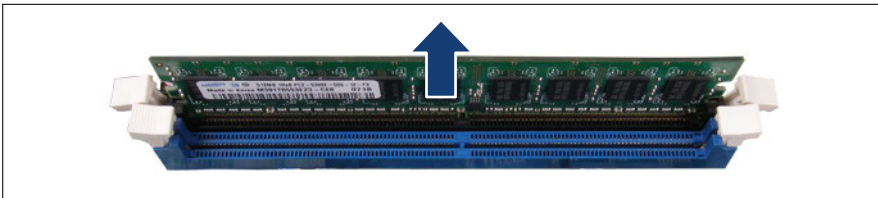

Figure 144: Removing memory modules (B)

- ▶ Remove the ejected memory module.

Concluding steps

- ▶ ["Reassembling"](#) on page 56.
- ▶ ["Connecting the power cord"](#) on page 59.
- ▶ ["Switching on the server"](#) on page 63.
- ▶ ["Resuming BitLocker functionality"](#) on page 90.

10.5 Replacing memory modules



Upgrade and Repair Unit (URU)



Hardware: 5 minutes
Software: 5 minutes

Tools: tool-less

Preliminary steps

- ▶ ["Locating the defective server"](#) on page 45.
- ▶ ["Suspending BitLocker functionality"](#) on page 73.
- ▶ ["Shutting down the server"](#) on page 47.
- ▶ ["Disconnecting the power cord"](#) on page 48.
- ▶ ["Getting access to the component"](#) on page 50.
- ▶ ["Locating the defective component"](#) on page 46.

Removing the defective memory module

- ▶ Remove the memory module, see ["Removing a memory module"](#) on page 236.

Installing the new memory module

- ▶ Install the memory module, see ["Installing a memory module"](#) on page 234.

Concluding steps

- ▶ ["Reassembling" on page 56.](#)
- ▶ ["Connecting the power cord" on page 59.](#)
- ▶ ["Switching on the server" on page 63.](#)
- ▶ ["Enabling replaced components in the BIOS" on page 86.](#)
- ▶ ["Resuming BitLocker functionality" on page 90.](#)

11 Processor (CPU)

11.1 Safety notes



CAUTION

- ▶ Do not install unsupported CPUs. For more information on supported CPUs, see "[Basic information](#)" on page 21.
- ▶ Circuit boards and soldered parts of internal options are exposed and can be damaged by static electricity. Always discharge static build-up (e.g. by touching a grounded object) before handling electrostatic sensitive devices (ESDs).
- ▶ Do not touch the circuitry on boards or soldered parts. Hold circuit boards by their metallic areas or edges.
- ▶ When removing or installing CPUs, be careful not to touch or bend the spring contacts on the CPU sockets.
- ▶ Never touch the underside of the CPUs. Even minor soiling such as grease from the skin can impair the CPU's operation or destroy the CPUs.
- ▶ For more information, see "[Important information](#)" on page 31.

11.2 Basic information

Supported CPUs

- One Intel® Xeon® CPU E23xx or Pentium, up to 95 W, up to 8 cores
- One CPU socket LGA 1200
- Thermal Design Power (TDP) class: up to 95 W



For system relevant information, see the hardware configurator of your server available online at the following address:

https://ts.fujitsu.com/products/standard_servers/index.htm

For Japan:

<https://www.fujitsu.com/jp/products/computing/servers/primergy/>

11.3 Upgrading or replacing the CPU



Field Replaceable Unit (FRU)



Hardware: 15 minutes

Software: 5 minutes

Tools: Phillips PH2 / (+) No. 2 screw driver



CAUTION

CPUs are extremely sensitive to electrostatic discharge and therefore must always be handled with care.

- ▶ After a CPU has been removed from its protective sleeve or from its socket, place it upside down on a nonconducting, antistatic surface.
- ▶ Never push a CPU over a surface.

Preliminary steps

- ▶ ["Locating the defective server" on page 45.](#)
- ▶ ["Suspending BitLocker functionality" on page 73.](#)
- ▶ ["Shutting down the server" on page 47.](#)
- ▶ ["Disconnecting the power cord" on page 48.](#)
- ▶ ["Getting access to the component" on page 50.](#)

Removing the standard heat sink

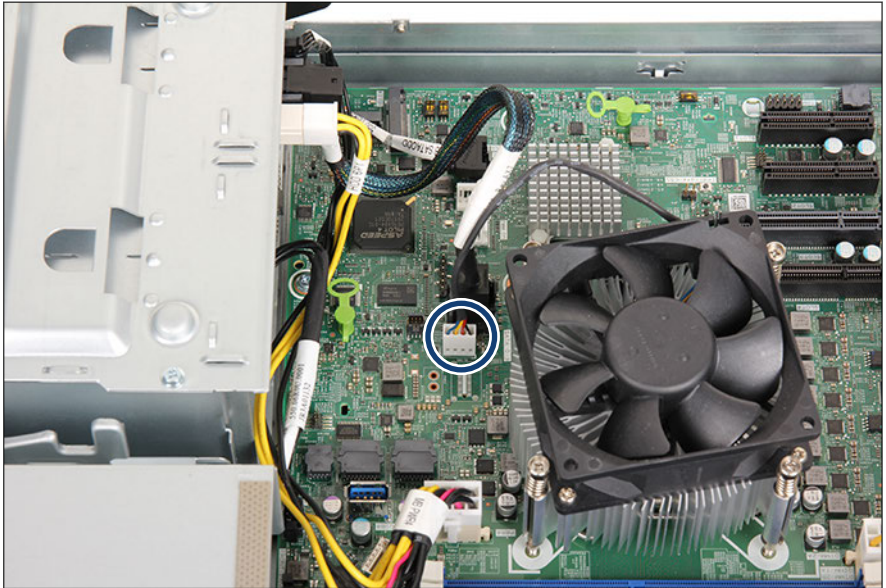

Figure 145: Disconnecting the CPU fan cable

- ▶ Disconnect the CPU fan cable from the connector “FAN CPU” on the system board (see circle).

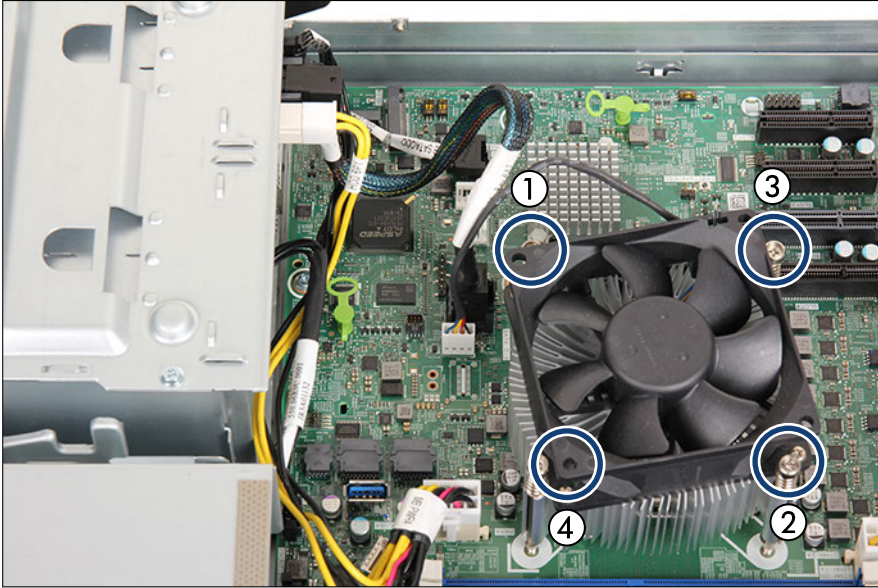

Figure 146: Removing the standard heat sink

- ▶ Loosen the four captive screws on the heat sink in a crossover pattern (1-4).
- ▶ Carefully twist the heat sink back and forth to detach it from the CPU.



This may be necessary due to the adhesive quality of the thermal paste located between the heat sink and CPU.



CAUTION

- ▶ Pay special attention not to damage any system board components surrounding the CPU socket.
- ▶ Lift the heat sink out of the chassis.
- ▶ Clean residual thermal paste from the CPU surface using a lint-free cloth and store the CPU in a safe place.

Removing the performance heat sink

- ▶ Disconnect the CPU fan cable from the connector "FAN CPU" on the system board, see [Figure 145](#).

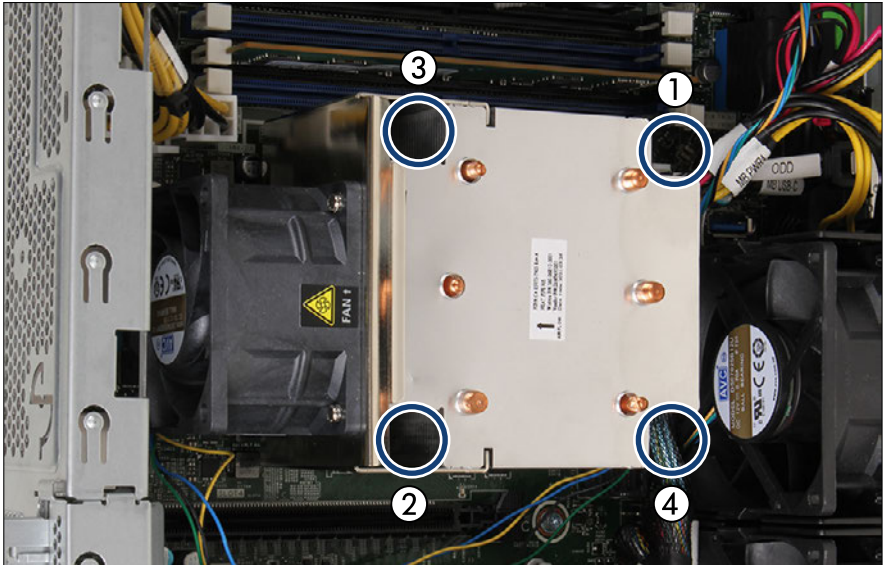

Figure 147: Removing the performance heat sink

- ▶ Loosen the four captive screws on the heat sink in a crossover pattern (1-4).
- ▶ Carefully twist the heat sink back and forth to detach it from the CPU.



This may be necessary due to the adhesive quality of the thermal paste located between the heat sink and CPU.



CAUTION

- ▶ Pay special attention not to damage any system board components surrounding the CPU socket.
- ▶ Lift the heat sink out of the chassis.
- ▶ Clean residual thermal paste from the CPU surface using a lint-free cloth and store the CPU in a safe place.

Removing the CPU

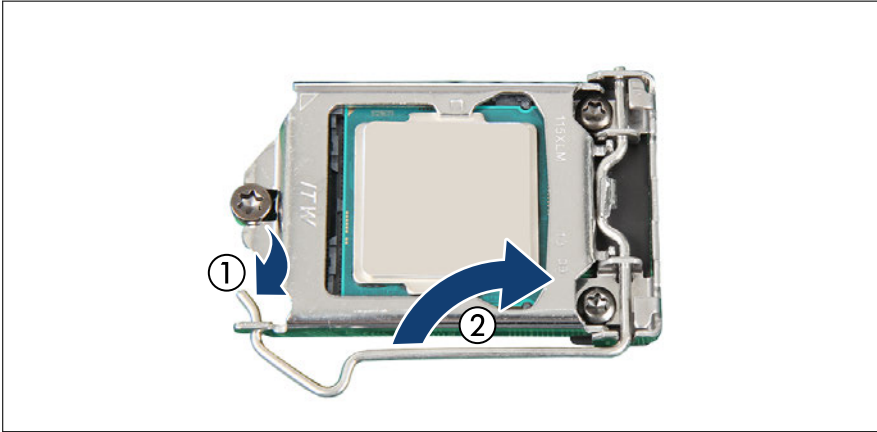

Figure 148: Unlatching the socket release lever

- ▶ Unlatch the socket release lever by pushing it down and away from the socket (1).
- ▶ Fold back the socket release lever (2).

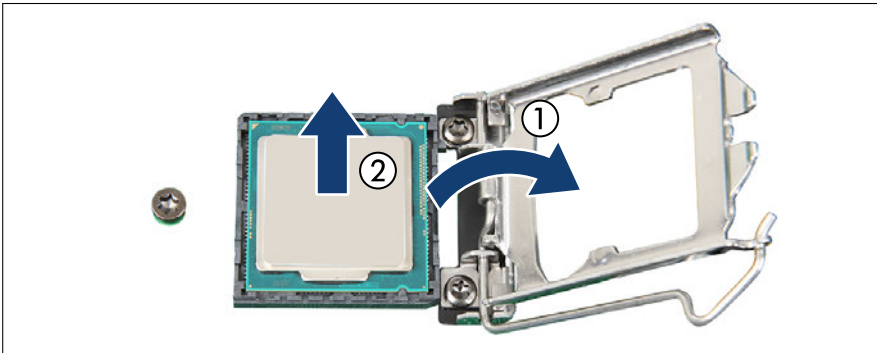

Figure 149: Removing the CPU

- ▶ Rotate the socket release lever to lift the load plate away from the socket (1).
Make sure that the load plate is in the fully open position.
- ▶ Carefully remove the CPU from its socket in a vertical motion (2).

**CAUTION**

- ▶ Be careful not to touch or bend the spring contacts on the CPU socket.

Installing the CPU

- ▶ Confirm that the CPU model number printed on the top of the CPU fits with the requirements.
- ▶ If applicable, remove the protective cap from the bottom side of the CPU.

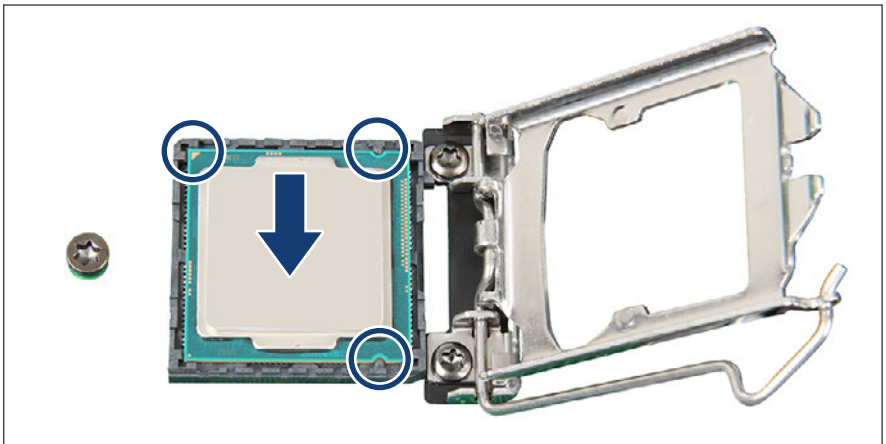

Figure 150: Installing the CPU

- ▶ Hold the CPU with your thumb and index finger. Make sure that the notches on the CPU align with the posts on the socket (see circles).
- ▶ Lower the CPU straight down without tilting or sliding it in the socket.

**CAUTION**

- ▶ Ensure that the CPU is level in the socket.
- ▶ Be careful not to touch or bend the pins on the CPU socket.
- ▶ Never touch the underside of the CPU. Even minor soiling such as grease from the skin can impair the CPU's operation or destroy the CPU.
- ▶ Ensure not to scrape or dent the CPU edges.

Processor (CPU)

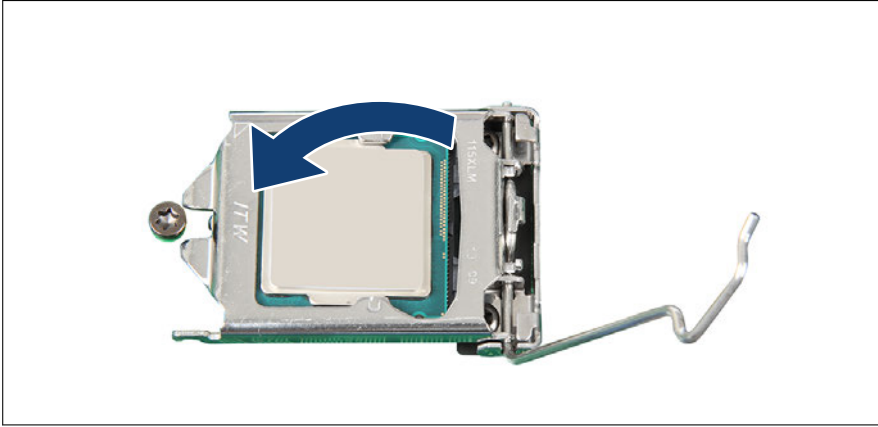

Figure 151: Closing the load plate (A)

- ▶ Lower the load plate over the CPU while leaving the socket release lever in its open position.

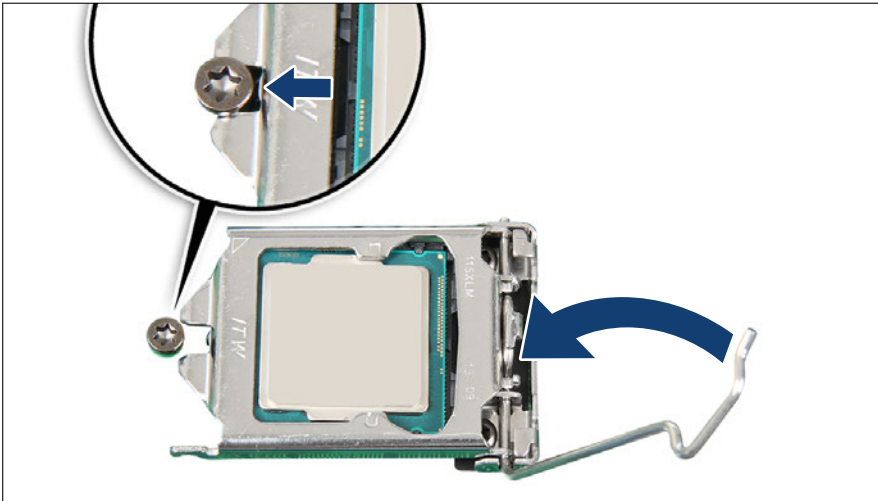

Figure 152: Closing the load plate (B)

- ▶ Lower the socket release lever while making sure that the front edge of the load plate slides under the shoulder screw cap (see close-up) as the lever is lowered.

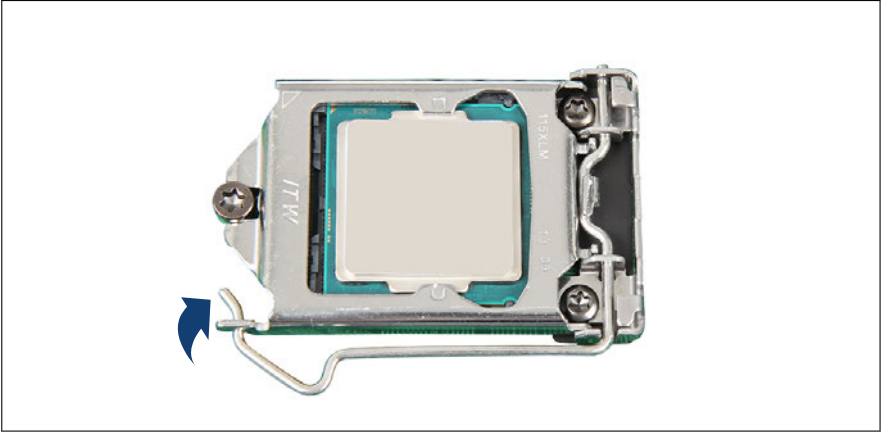

Figure 153: Latching the socket release lever

- ▶ Latch the socket release lever under the load plate tab.

Applying thermal paste to the CPU surface

- i** For Japan, the service engineer must follow the instruction provided separately.
- i** If the CPU upgrade or replacement kit contains a new heat sink, a thin layer of thermal compound has already been pre-applied to its lower surface. In this case, it isn't necessary to apply thermal paste to the CPU surface.

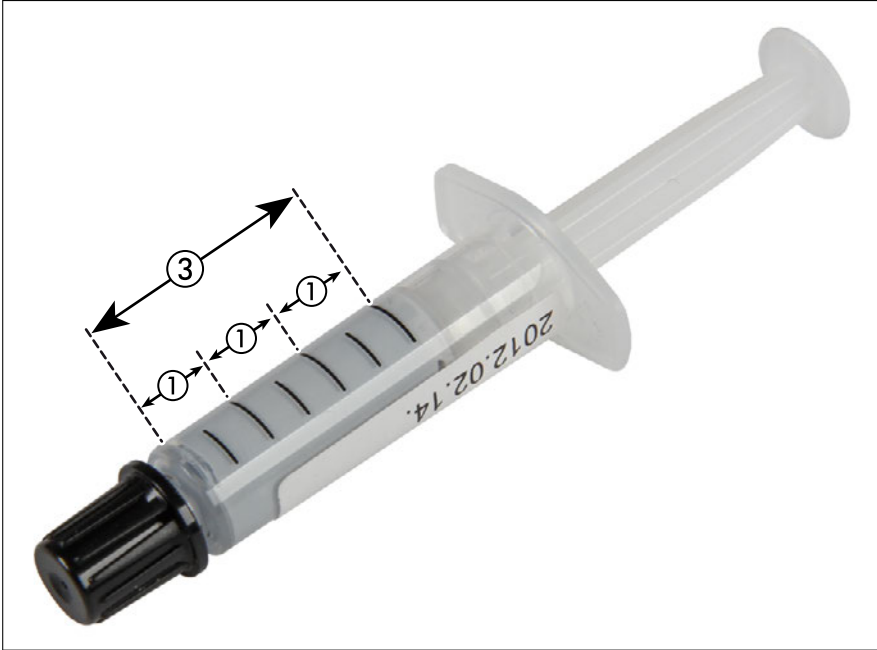

Figure 154: Thermal paste syringe

One thermal compound syringe (FSP:P304000004) contains thermal paste for three CPUs.

In order to determine the correct amount of thermal paste (equal to 1.0 gram), divide the grey area of the syringe up into three equal segments.



Add graduation marks to the syringe using a permanent marker to help you apply the thermal paste.

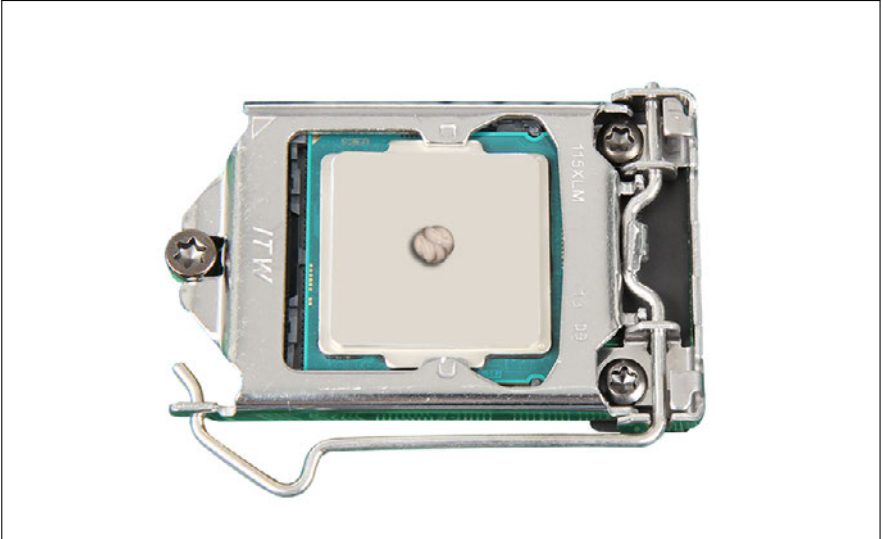

Figure 155: Applying the thermal paste

- ▶ Apply a small point-shaped amount of thermal paste (1.0 gram, see description above) to the center of the CPU surface as shown.



CAUTION

- ▶ Do not mix different types of thermal paste.

Installing the standard heat sink



The standard heat sink is used for CPUs up to 80 W TDP and ambient temperature up to 35 °C.

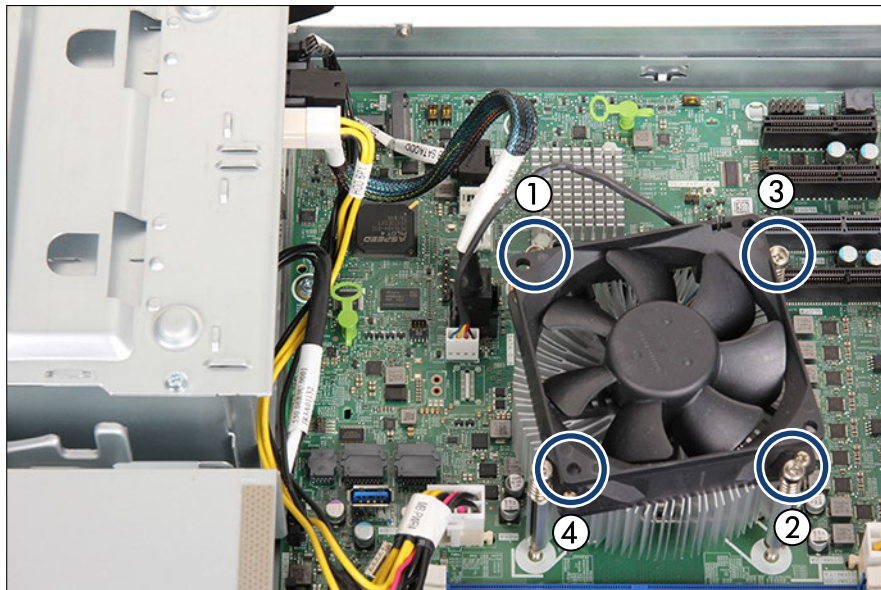

Figure 156: Installing the standard heat sink

- ▶ Carefully place the heat sink on the four threaded holes as shown.



CAUTION

- ▶ Ensure that the screws on the heat sink are properly seated on the threaded holes.
 - ▶ Ensure that the heat sink cooling fins match the direction of the airflow!
- ▶ Fasten the four captive screws on the heat sink in a crossover pattern (screw torque: 0.6 Nm, not applicable for Japan) (1-4).

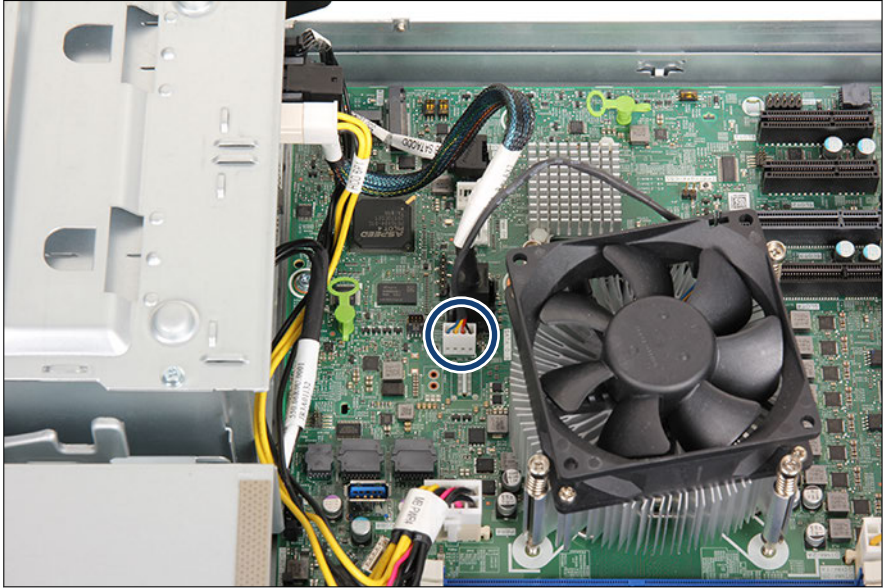

Figure 157: Connecting the CPU fan cable

- ▶ Connect the CPU fan cable to the connector "FAN CPU" on the system board (see circle).

Installing the performance heat sink

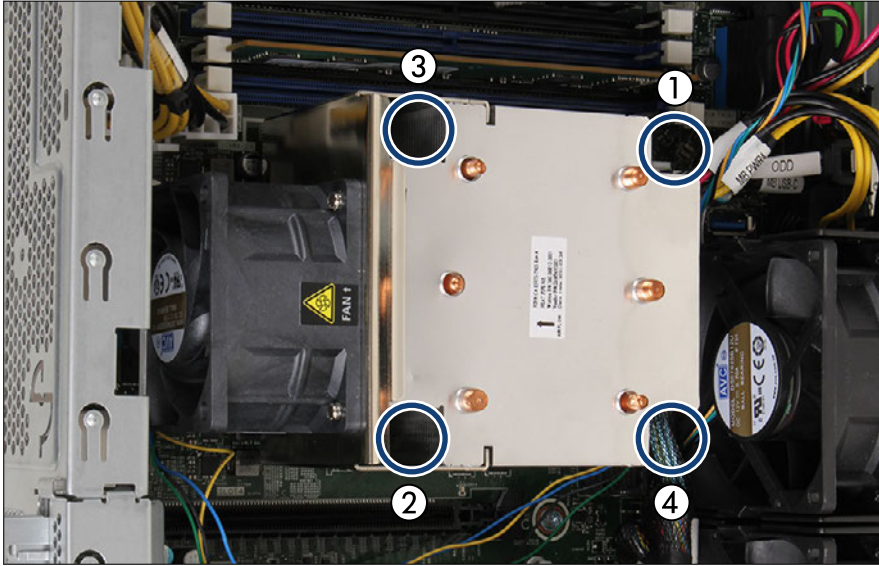

Figure 158: Installing the performance heat sink

- ▶ Carefully place the heat sink on the four threaded holes as shown.



CAUTION

- ▶ Ensure that the screws on the heat sink are properly seated on the threaded holes.
- ▶ Ensure that the heat sink cooling fins match the direction of the airflow!
- ▶ Fasten the four captive screws on the heat sink in a crossover pattern (screw torque: 0.6 Nm, not applicable for Japan) (1-4).
- ▶ Connect the CPU fan cable to the connector "FAN CPU" on the system board, see [Figure 157](#).

Concluding steps

- ▶ "[Reassembling](#)" on page 56.
- ▶ "[Connecting the power cord](#)" on page 59.

- ▶ ["Switching on the server" on page 63.](#)



When the system is powered on after a CPU has been replaced or upgraded, the Global Error indicator will start flashing with the message CPU has been changed.

This only indicates that the CPU configuration has been altered. There is no technical problem.

Proceed as follows:

- Restart your server.
 - As soon as the startup screen appears, press the [F2] function key to enter the BIOS.
 - If a password is assigned, enter the password and press [Enter].
 - Select the **Save & Exit** menu.
 - Select **Save Changes and Exit** or **Save Changes and Reset**.
 - Verify that the Global Error indicator stops flashing.
- ▶ If applicable, ["Updating or recovering the BIOS and iRMC S6" on page 78.](#)
 - ▶ ["Enabling replaced components in the BIOS" on page 86.](#)
 - ▶ ["Resuming BitLocker functionality" on page 90.](#)

11.4 Replacing the heat sink



Field Replaceable Unit
(FRU)



Hardware: 15 minutes

Tools: Phillips PH2 / (+) No. 2 screw driver

Preliminary steps

- ▶ ["Locating the defective server" on page 45.](#)
- ▶ ["Shutting down the server" on page 47.](#)
- ▶ ["Disconnecting the power cord" on page 48.](#)

Processor (CPU)

- ▶ ["Getting access to the component" on page 50.](#)

Removing the defective heat sink

- ▶ Remove the heat sink, see ["Removing the standard heat sink" on page 241](#) or ["Removing the performance heat sink" on page 242.](#)
- ▶ Remove the residual thermal paste from the CPU surface.
- ▶ Clean the CPU surface using a lint-free cloth.

Installing the new heat sink

- ▶ Remove the protective cover on the underside of the new heat sink.



- ▶ Do not touch the thermal paste on the underside of the heat sink.
- ▶ Install the heat sink, see ["Installing the standard heat sink" on page 249](#) or ["Installing the performance heat sink" on page 252.](#)

Concluding steps

- ▶ ["Reassembling" on page 56.](#)
- ▶ ["Connecting the power cord" on page 59.](#)
- ▶ ["Switching on the server" on page 63.](#)
- ▶ ["Performing a fan test" on page 99.](#)

12 Accessible drives

12.1 Safety notes



CAUTION

- ▶ Before installing an accessible drive, acquaint yourself with the drive's user documentation.
- ▶ When inserting an accessible drive into the server, ensure not to pinch or strain any connected cables.
- ▶ When installing an accessible drive, hold it by its sides. Applying force to the top of the casing may cause failures.
- ▶ When disposing of, transferring, or returning a backup drive, ensure that all backup media has been removed from the drive.
- ▶ Circuit boards and soldered parts of internal options are exposed and can be damaged by static electricity. Always discharge static build-up (e.g. by touching a grounded object) before handling electrostatic-sensitive devices (ESDs).
- ▶ Do not touch the circuitry on boards or soldered parts. Hold circuit boards by their metallic areas or edges.
- ▶ For more information, see "[Important information](#)" on page 31.

12.2 Basic information

Mounting order for accessible drives

PRIMERGY TX1320 M5 server offers a 5.25-inch slimline SATA ODD bay and 3.5-inch RDX backup drive bay.

Accessible drives

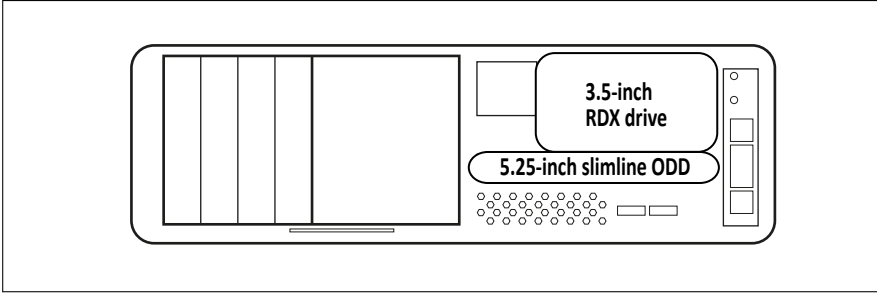

Figure 159: Accessible drives mounting order

	Accessible drive	Max. #
5.25-inch bay 2	ODD	1
3.5-inch bay	Backup drive	1

Table 4: Accessible drive mounting sequence

12.3 Optical disk drive (ODD)

12.3.1 Installing the ODD



Upgrade and Repair Unit (URU)



Hardware: 10 minutes

Tools: Phillips PH1 / (+) No. 1 screw driver

Preliminary steps

- ▶ ["Suspending BitLocker functionality" on page 73.](#)
- ▶ ["Checking boot priority" on page 77.](#)
- ▶ ["Shutting down the server" on page 47.](#)
- ▶ ["Disconnecting the power cord" on page 48.](#)
- ▶ ["Getting access to the component" on page 50.](#)

Removing the ODD dummy cover

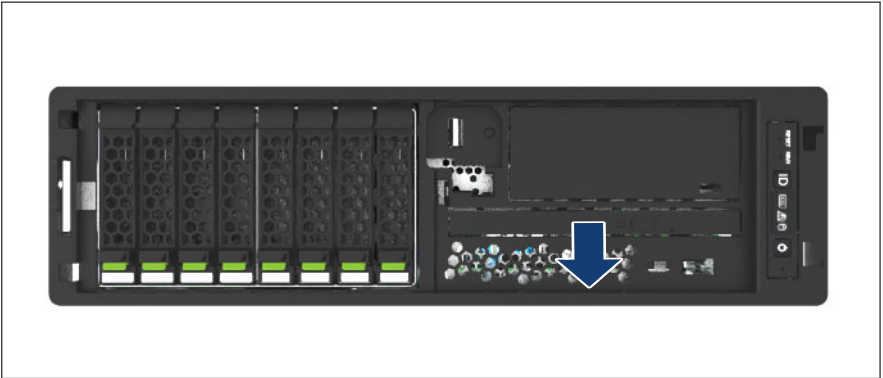

Figure 160: Removing the ODD dummy cover

- If applicable, remove the ODD dummy cover.

Removing the ODD filler cover

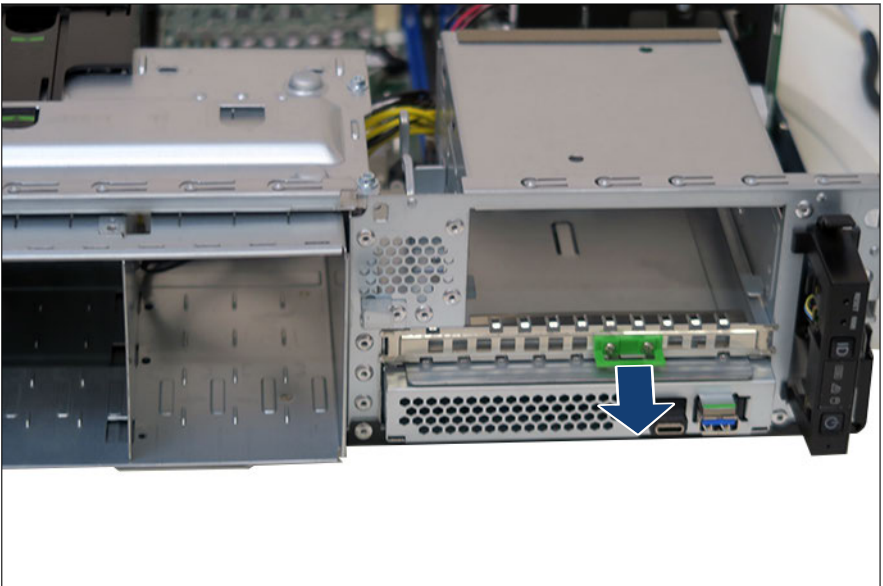

Figure 161: Removing the ODD filler cover

Accessible drives

- ▶ Grip the ODD latch of the ODD filler cover.



CAUTION

- ▶ Save the ODD filler cover for future use.

Always replace dummy modules into unused drive bays to comply with applicable EMC regulations and satisfy cooling requirements.

- ▶ Pull out the ODD filler cover and remove it from its installation bay.

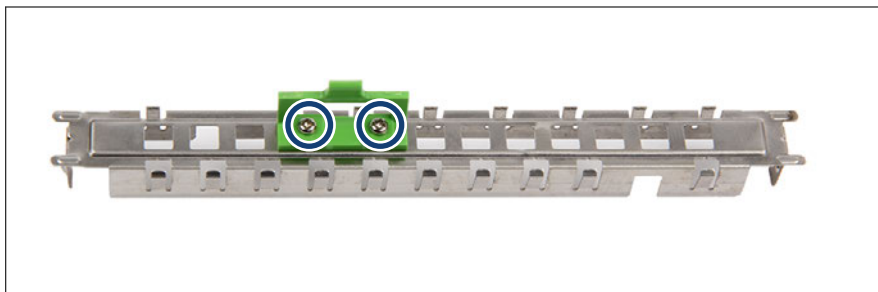

Figure 162: Removing the ODD latch

- ▶ Remove the two screws (see circles).
- ▶ Remove the ODD latch from the ODD filler cover.

Installing the ODD



Figure 163: Installing the ODD latch on the ODD

- Fasten the ODD latch with two screws to the rear side of the ODD (see circles).

Accessible drives

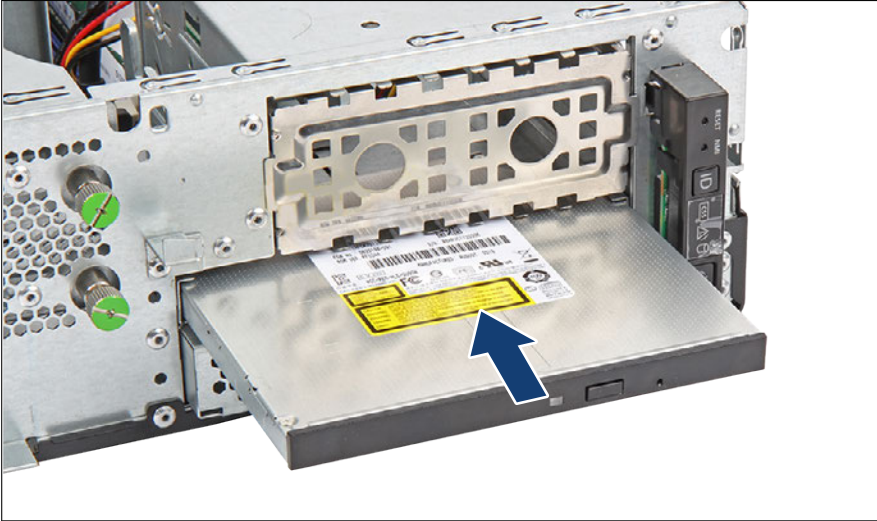

Figure 164: Installing the ODD (A)

- ▶ Insert the ODD into its bay and push it until the ODD latch is visible on the rear of the cage.



Figure 165: Installing the ODD (B)

- ▶ Press down the ODD latch (see circle) and push the ODD back until it engages.

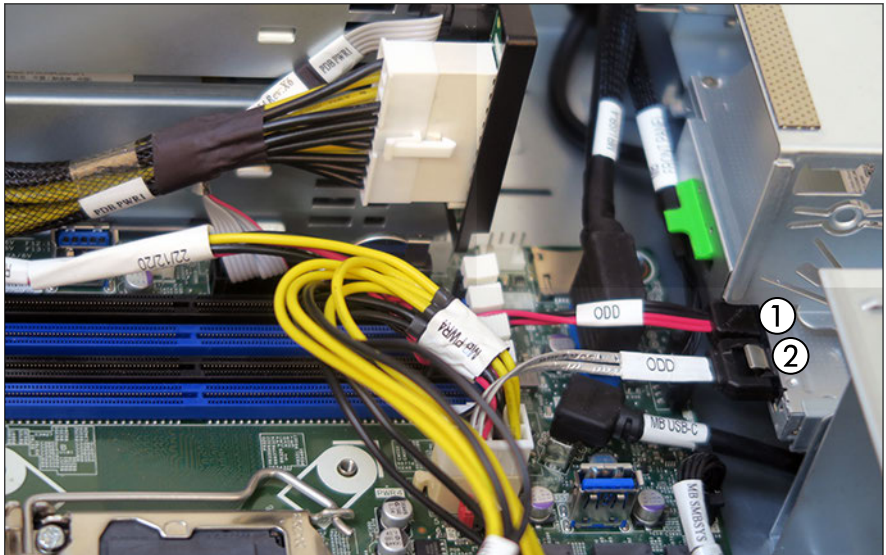

Figure 166: Connecting cables to the ODD

- ▶ Connect the cables to the ODD:
 - 1 Power cable connector “ODD” to the connector on the ODD
 - 2 SATA cable to the ODD and to the connector “SATA ODD” on the system board



For the cable plan, see ["Appendix B" on page 391](#).

Concluding steps

- ▶ ["Reassembling" on page 56](#).
- ▶ ["Connecting the power cord" on page 59](#).
- ▶ ["Switching on the server" on page 63](#).
- ▶ ["Setting boot priority" on page 100](#).

- ▶ ["Resuming BitLocker functionality" on page 90.](#)

12.3.2 Removing the ODD



Field Replaceable Unit (FRU)



Hardware: 10 minutes

Tools: Phillips PH1 / (+) No. 1 screw driver (Japan)

Preliminary steps

- ▶ ["Removing backup and optical disk media" on page 76.](#)
- ▶ ["Suspending BitLocker functionality" on page 73.](#)
- ▶ ["Shutting down the server" on page 47.](#)
- ▶ ["Disconnecting the power cord" on page 48.](#)
- ▶ ["Getting access to the component" on page 50.](#)

Removing an ODD

- ▶ Disconnect all cables from the ODD.

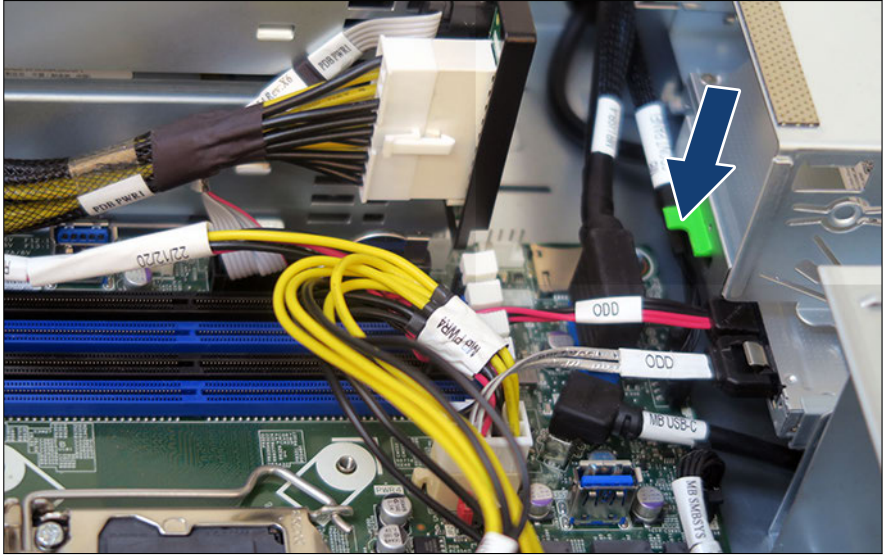

Figure 167: Unlocking the ODD

- ▶ Press the ODD latch in direction of the arrow until it disengages.

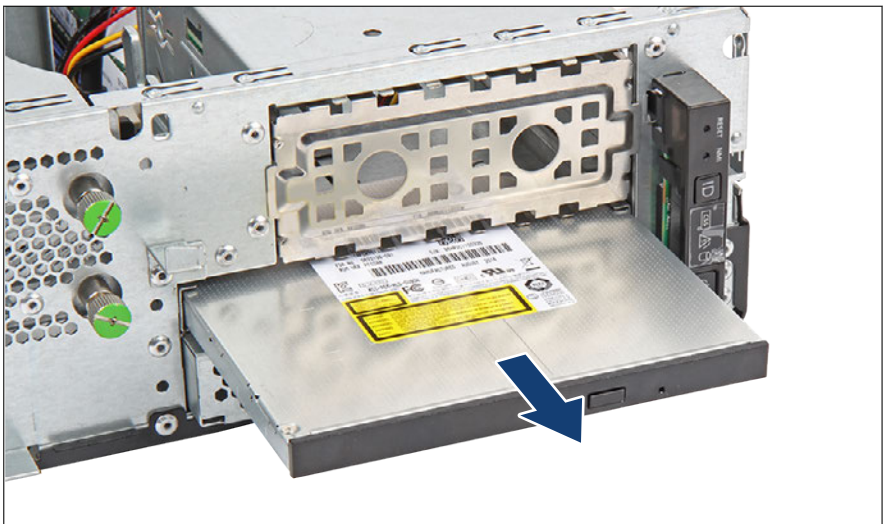

Figure 168: Removing the ODD

Accessible drives

- ▶ Pull the ODD out of the bay.

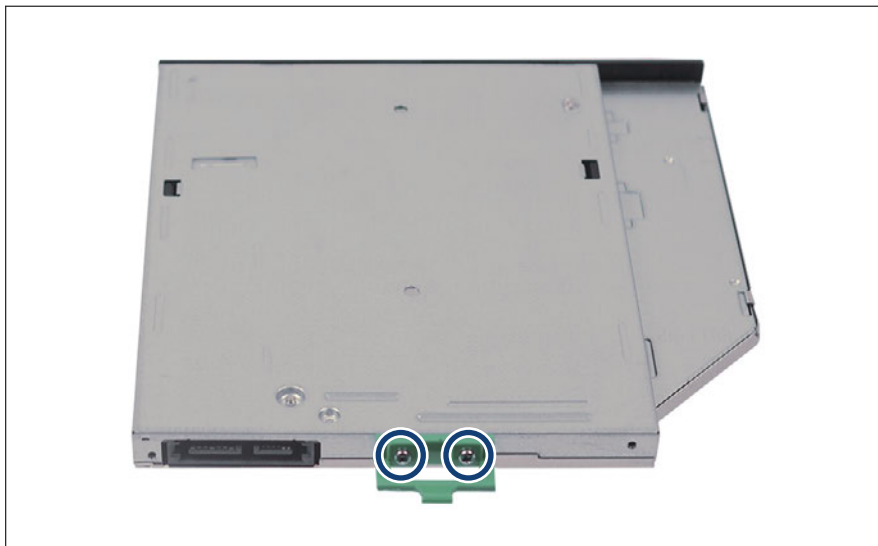

Figure 169: Removing the ODD latch

- ▶ Remove the two screws (see circles).
- ▶ Remove the ODD latch.

If no new ODD will be installed:

- ▶ Fasten the ODD latch with two screws to the ODD filler cover, see [Figure 163](#).

Installing the ODD filler cover

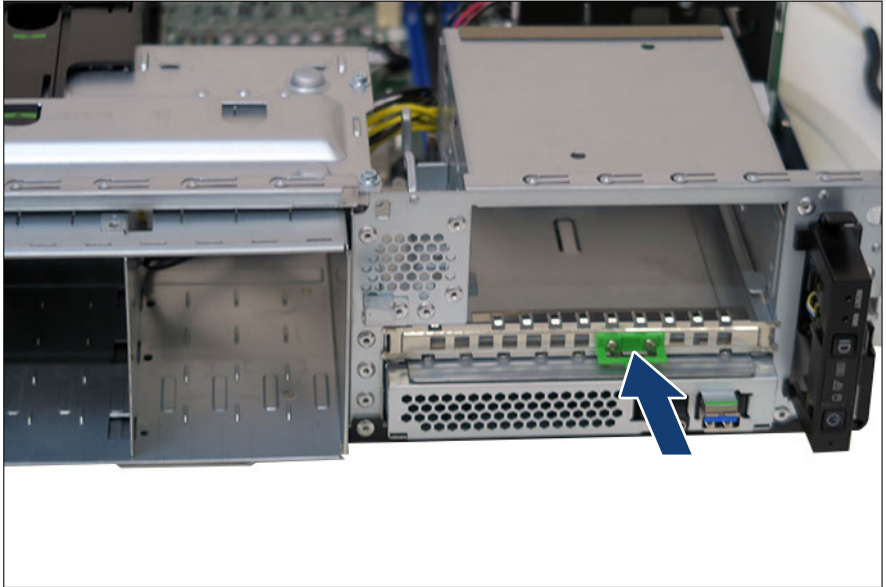

Figure 170: Installing the ODD filler cover

- ▶ Install the ODD filler cover into the empty bay.

Concluding steps

- ▶ "Reassembling" on page 56.
- ▶ "Connecting the power cord" on page 59.
- ▶ "Switching on the server" on page 63.
- ▶ "Resuming BitLocker functionality" on page 90.

12.3.3 Replacing the ODD



**Field Replaceable Unit
(FRU)**



Hardware: 15 minutes

Accessible drives

Tools: Phillips PH1 / (+) No. 1 screw driver

Preliminary steps

- ▶ ["Locating the defective server" on page 45.](#)
- ▶ ["Removing backup and optical disk media" on page 76.](#)
- ▶ ["Suspending BitLocker functionality" on page 73.](#)
- ▶ ["Checking boot priority" on page 77.](#)
- ▶ ["Shutting down the server" on page 47.](#)
- ▶ ["Disconnecting the power cord" on page 48.](#)
- ▶ ["Getting access to the component" on page 50.](#)

Removing the defective ODD

- ▶ Remove the ODD, see ["Removing the ODD" on page 262.](#)

Installing the new ODD

- ▶ Install the ODD, see ["Installing the ODD" on page 256.](#)

Concluding steps

- ▶ ["Reassembling" on page 56.](#)
- ▶ ["Connecting the power cord" on page 59.](#)
- ▶ ["Switching on the server" on page 63.](#)
- ▶ ["Setting boot priority" on page 100.](#)
- ▶ ["Resuming BitLocker functionality" on page 90.](#)

12.4 RDX drive

12.4.1 Installing the RDX drive



Upgrade and Repair Unit (URU)



Hardware: 10 minutes

Tools: Phillips PH2 / (+) No. 2 screw driver

Preliminary steps

- ▶ ["Suspending BitLocker functionality" on page 73.](#)
- ▶ ["Shutting down the server" on page 47.](#)
- ▶ ["Disconnecting the power cord" on page 48.](#)
- ▶ ["Getting access to the component" on page 50.](#)

Removing the RDX drive dummy cover

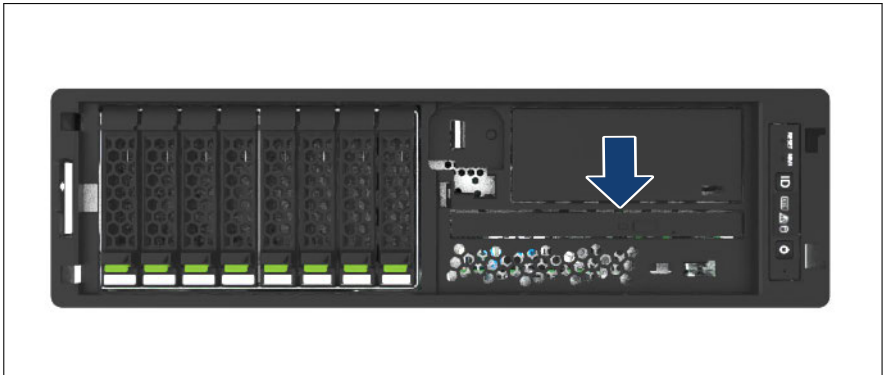

Figure 171: Removing the RDX drive dummy cover

- ▶ Remove the drive dummy cover.

Removing the RDX drive filler cover

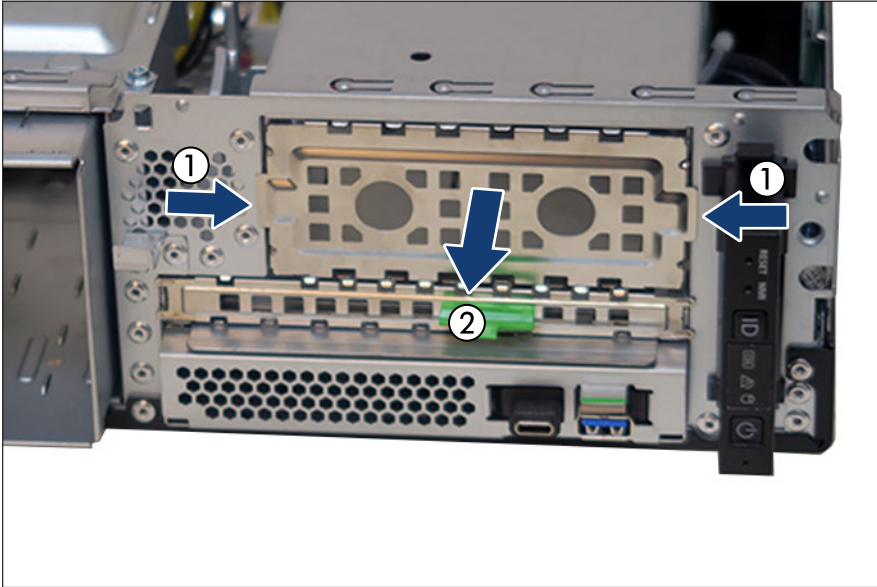

Figure 172: Removing the RDX drive filler cover

- ▶ Hold the RDX drive filler cover by the two handle recesses (1).
- ▶ Pull out the RDX drive filler cover (2).



CAUTION

- ▶ Keep the drive filler cover for future use.
- ▶ Always replace dummy modules into unused drive bays to comply with applicable EMC regulations and satisfy cooling requirements.

Installing the RDX drive

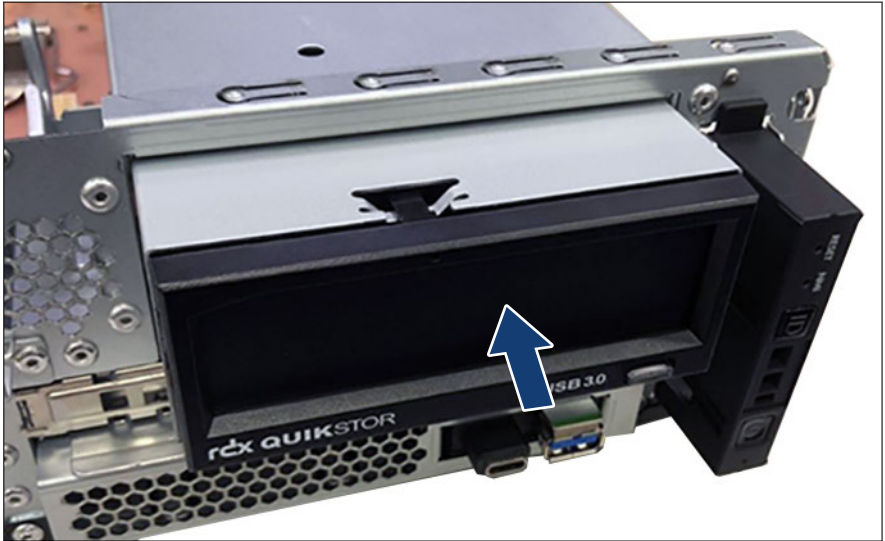

Figure 173: Installing the RDX drive (A)

- ▶ Insert the RDX drive into its installation bay.
- ▶ Carefully push back until the RDX drive cover plate is flush with the front panel.

Accessible drives

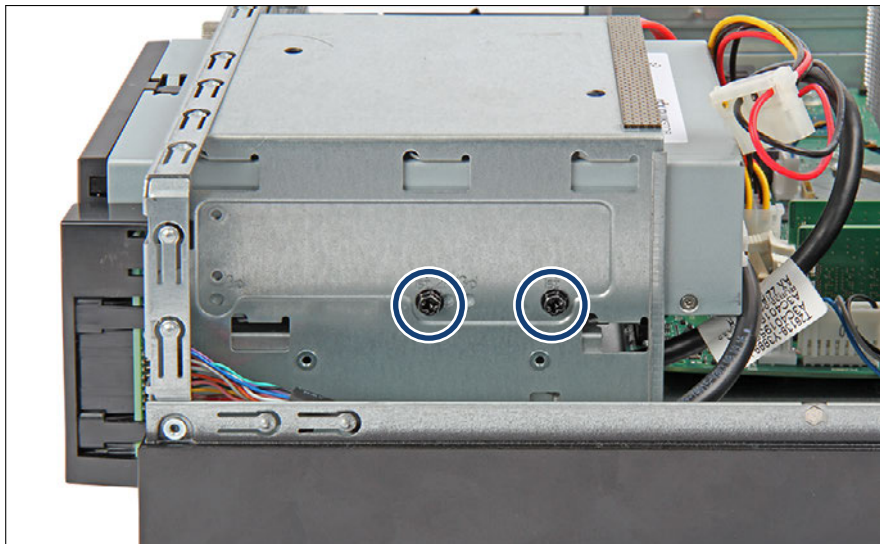

Figure 174: Installing the RDX drive (B)

- ▶ Fasten the RDX drive to the drive cage with two screws.



Use the screw hole marked "1st".

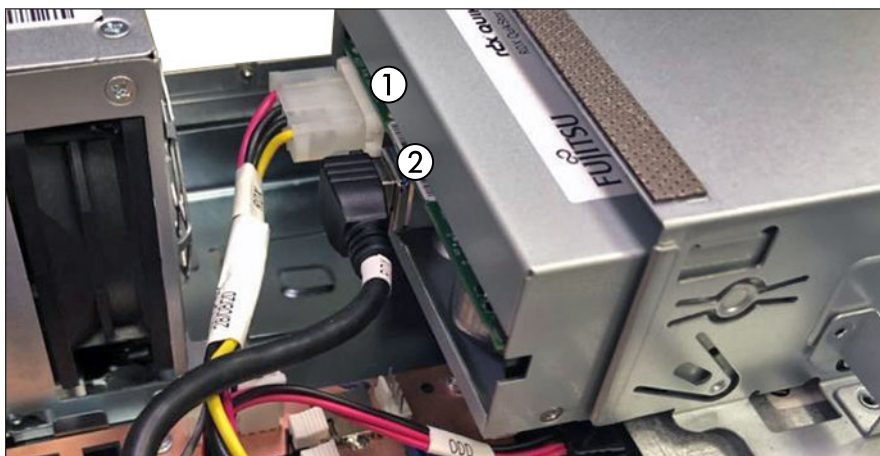

Figure 175: Connecting cables to the RDX drive

- ▶ Connect the cables to the RDX drive:
 - 1 Power cable connector “RDX” to the connector on the RDX drive
 - 2 USB cable to the RDX drive and to the connector “USB8” on the system board

Concluding steps

- ▶ ["Reassembling" on page 56.](#)
- ▶ ["Connecting the power cord" on page 59.](#)
- ▶ ["Switching on the server" on page 63.](#)
- ▶ ["Resuming BitLocker functionality" on page 90.](#)



For the cable plan, see ["Appendix B" on page 391.](#)

12.4.2 Removing the RDX drive



Field Replaceable Unit (FRU)



Hardware: 10 minutes

Tools: Phillips PH2 / (+) No. 2 screw driver

Preliminary steps

- ▶ ["Removing backup and optical disk media" on page 76.](#)
- ▶ ["Suspending BitLocker functionality" on page 73.](#)
- ▶ ["Shutting down the server" on page 47.](#)
- ▶ ["Disconnecting the power cord" on page 48.](#)
- ▶ ["Getting access to the component" on page 50.](#)

Removing the RDX drive

- ▶ Disconnect all cables from the RDX drive.

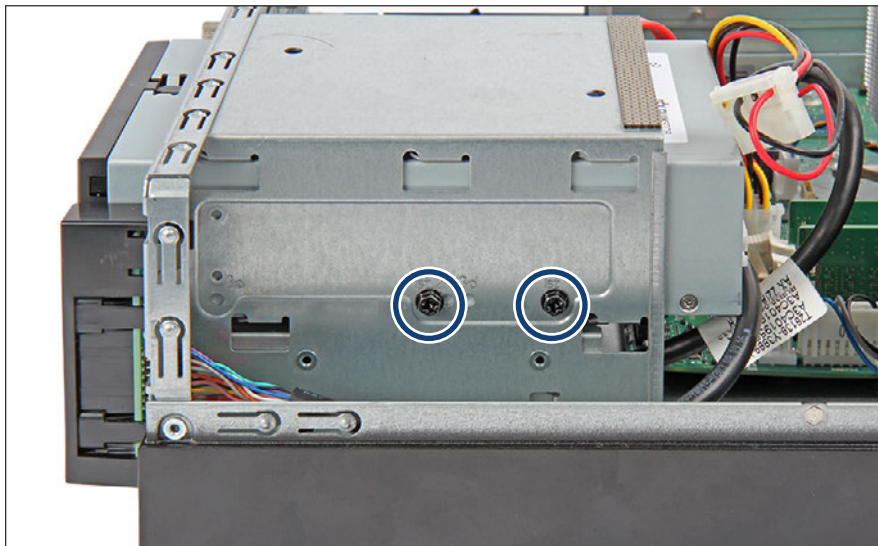

Figure 176: Removing the RDX drive (A)

- ▶ Remove the two screws (see circles).

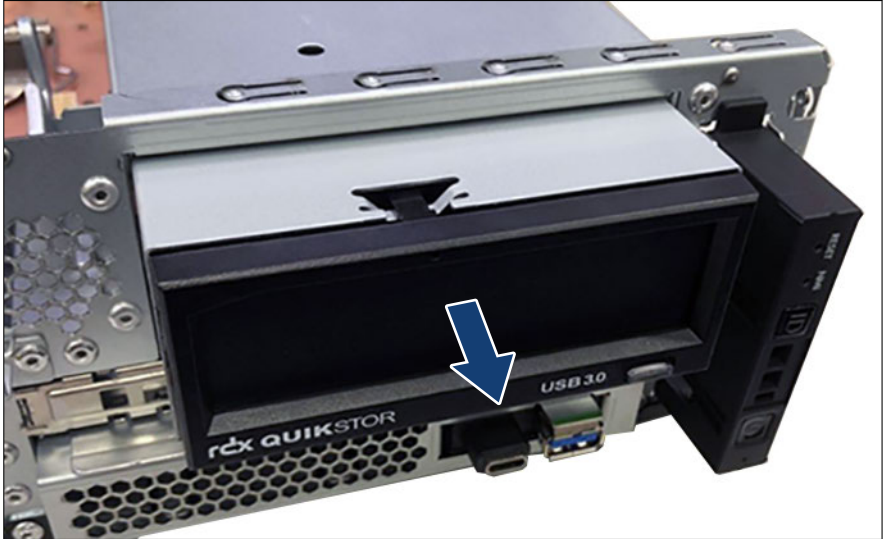

Figure 177: Removing the RDX drive (B)

- Pull the RDX drive out of its bay.

Installing the RDX drive filler cover



Figure 178: Installing the RDX drive filler cover

- ▶ Install the RDX drive filler cover.

Concluding steps

- ▶ ["Reassembling" on page 56.](#)
- ▶ ["Connecting the power cord" on page 59.](#)
- ▶ ["Switching on the server" on page 63.](#)
- ▶ ["Resuming BitLocker functionality" on page 90.](#)

12.4.3 Replacing the RDX drive



**Field Replaceable Unit
(FRU)**



Hardware: 10 minutes

Tools: Phillips PH2 / (+) No. 2 screw driver

Preliminary steps

- ▶ ["Locating the defective server" on page 45.](#)
- ▶ ["Removing backup and optical disk media" on page 76.](#)
- ▶ ["Suspending BitLocker functionality" on page 73.](#)
- ▶ ["Shutting down the server" on page 47.](#)
- ▶ ["Disconnecting the power cord" on page 48.](#)
- ▶ ["Getting access to the component" on page 50.](#)

Removing the defective RDX drive

- ▶ Remove the RDX drive, see ["Removing the RDX drive" on page 271.](#)

Installing the new RDX drive

- ▶ Install the RDX drive, see ["Installing the RDX drive" on page 267.](#)

Concluding steps

- ▶ ["Reassembling" on page 56.](#)
- ▶ ["Connecting the power cord" on page 59.](#)
- ▶ ["Switching on the server" on page 63.](#)
- ▶ ["Resuming BitLocker functionality" on page 90.](#)

13 Front panel

13.1 Safety notes



CAUTION

- ▶ When inserting the front panel module into the server, ensure not to pinch or strain any connected cables.
- ▶ Circuit boards and soldered parts of internal options are exposed and can be damaged by static electricity. Always discharge static build-up (e.g. by touching a grounded object) before handling electrostatic-sensitive devices (ESDs).
- ▶ Do not touch the circuitry on boards or soldered parts. Hold circuit boards by their metallic areas or edges.
- ▶ For more information, see "[Important information](#)" on page 31.

13.2 Replacing the front panel module



Field Replaceable Unit (FRU)



Hardware: 10 minutes
Software: 5 minutes

Tools: flat screw driver (for the retention hooks)

Note on system information backup/restore

The front panel (front panel module, front panel board or front panel on QRL) contains the Chassis ID EPROM that contains system information like server name and model, housing type, serial number and manufacturing data. To avoid the loss of non-default settings when replacing the system board, a backup copy of important system configuration data is automatically stored from the system board NVRAM to the Chassis ID EPROM.

Front panel



CAUTION

For that reason the front panel and system board must not be replaced simultaneously! In this case, restoring the system configuration data on the system board would fail.

When replacing the front panel, the system information like server name and model, housing type, serial number and manufacturing data are not restored automatically. So never forget to restore it manually by Chassis ID Prom Tool.

Preliminary steps

- ▶ ["Locating the defective server" on page 45.](#)
- ▶ ["Suspending BitLocker functionality" on page 73.](#)
- ▶ ["Shutting down the server" on page 47.](#)
- ▶ ["Disconnecting the power cord" on page 48.](#)
- ▶ ["Getting access to the component" on page 50.](#)

Removing the defective front panel module

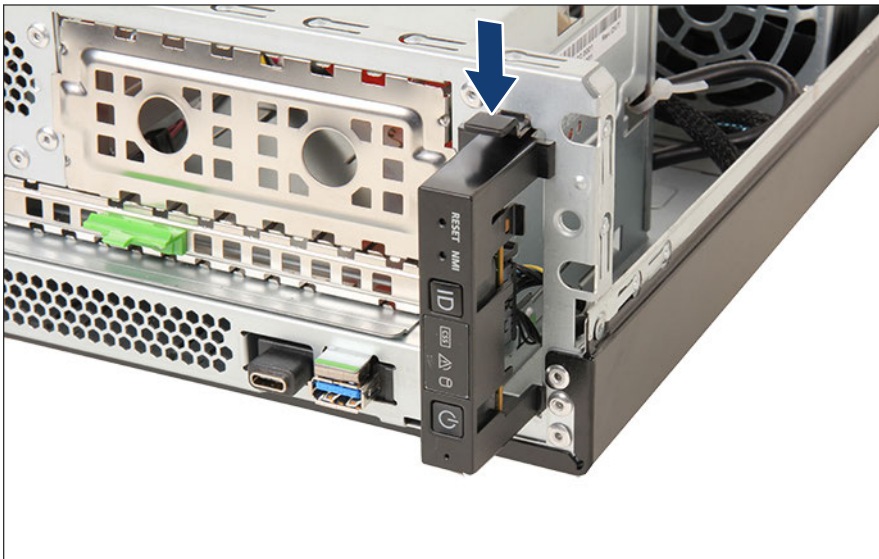

Figure 179: Removing the front panel module (A)

- ▶ Press the release latch to remove the front panel module.
- ▶ Pull out the front panel module.

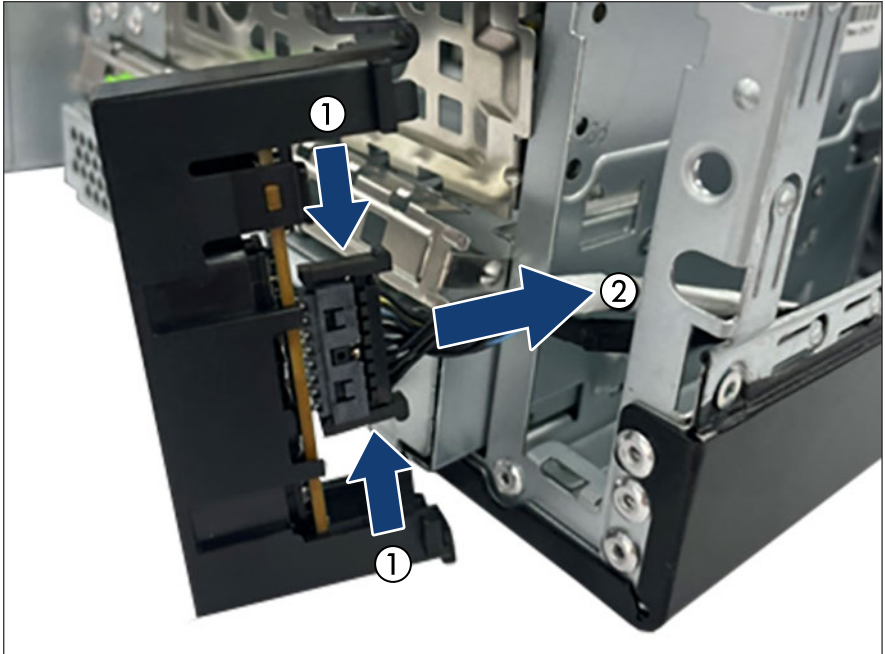

Figure 180: Removing the front panel module (B)

- ▶ Press the release latches (1).
- ▶ Disconnect the front panel cable (2).
- ▶ Remove the front panel module.

Installing the new front panel module

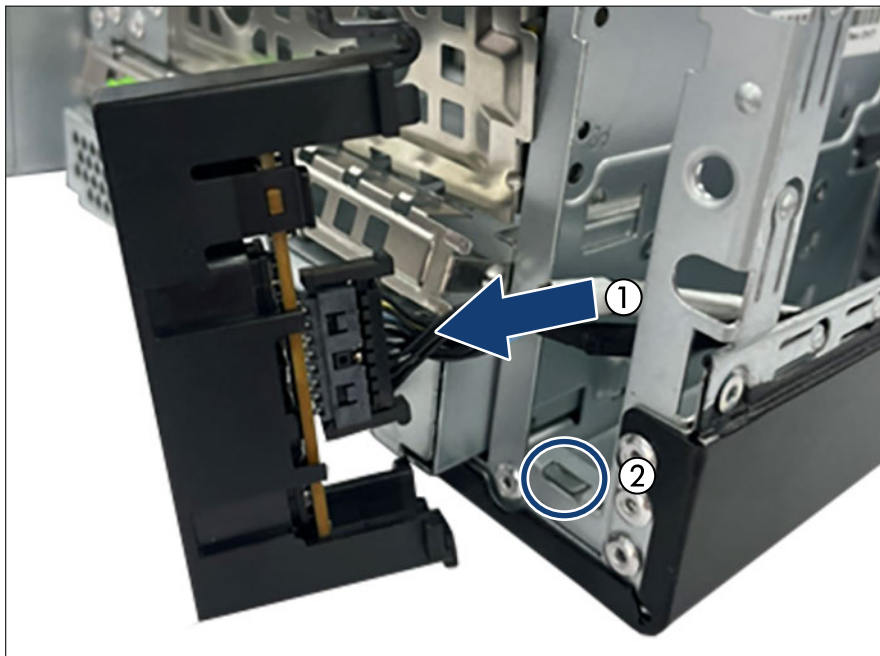

Figure 181: Installing the front panel module (A)

- ▶ Connect the front panel cable (1).
- ▶ Align the notch on the bottom of the chassis with the front panel module (2).

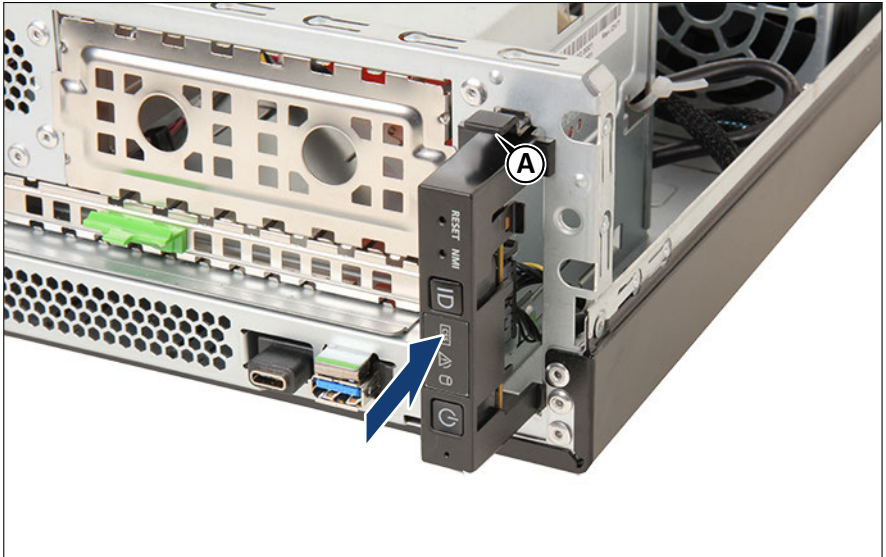

Figure 182: Installing the front panel module (B)

- ▶ Install the front panel module until the release latch (A) snaps in place.

Concluding steps

- ▶ ["Reassembling"](#) on page 56.
- ▶ ["Connecting the power cord"](#) on page 59.
- ▶ ["Switching on the server"](#) on page 63.
- ▶ ["Verifying system information backup or restore"](#) on page 80.
- ▶ ["Using the Chassis ID Prom Tool"](#) on page 95.
- ▶ ["Resuming BitLocker functionality"](#) on page 90.

14 Front USB connector

14.1 Installing a front USB connector



Upgrade and Repair Unit (URU)



Hardware: 5 minutes

Tools: Phillips PH2 / (+) No. 2 screw driver

Preliminary steps

- ▶ ["Shutting down the server" on page 47.](#)
- ▶ ["Disconnecting the power cord" on page 48.](#)
- ▶ ["Getting access to the component" on page 50.](#)

Removing the FBU tray

- ▶ Remove the FBU tray, see [Figure 136](#).

Front USB connector

Installing the front USB connector



Figure 183: Installing the front USB connector

- ▶ Place the front USB connector in the FBU tray and slide it in the direction of the arrow until it locks in place.
- ▶ Fasten the USB front connector with two screws (see circles).

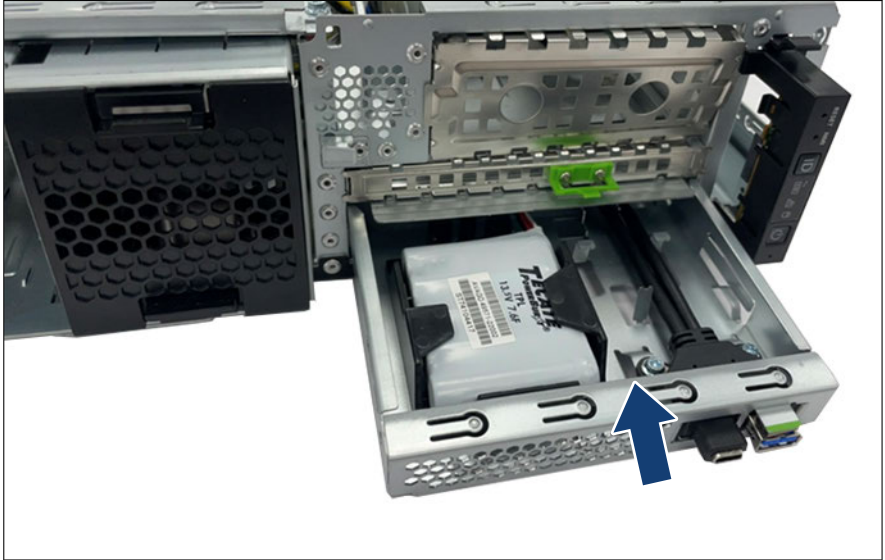

Figure 184: Installing the front USB connector

- ▶ Run the front USB connector cable through the opening.
- ▶ Insert the FBU tray into the corresponding bay and slide it in as far as it will go.

Connecting the front USB connector

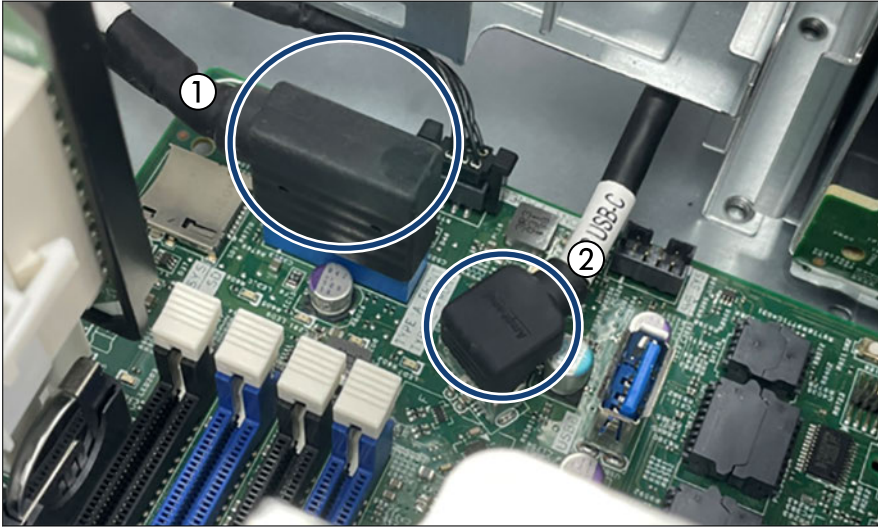

Figure 185: Connecting the front USB connector

- ▶ Connect the front USB connector cable to the connector "TYPE A FRONT" on the system board (1).
- ▶ Connect the front USB connector cable to the connector "TYPE C FRONT" on the system board (2).

Concluding steps

- ▶ ["Reassembling" on page 56.](#)
- ▶ ["Connecting the power cord" on page 59.](#)
- ▶ ["Switching on the server" on page 63.](#)

14.2 Removing a front USB connector



**Upgrade and Repair Unit
(URU)**



Hardware: 5 minutes

Tools: Phillips PH2 / (+) No. 2 screw driver

Preliminary steps

- ▶ "Shutting down the server" on page 47.
- ▶ "Disconnecting the power cord" on page 48.
- ▶ "Getting access to the component" on page 50.

Disconnecting the front USB connector

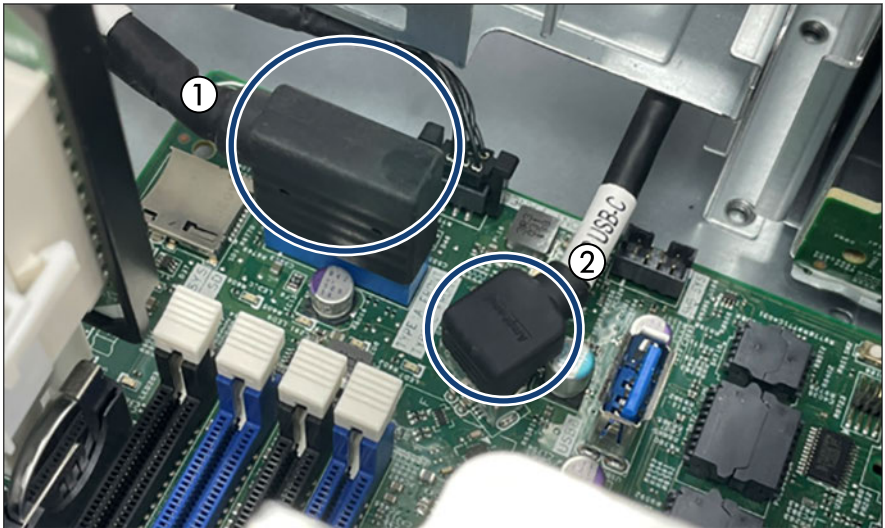

Figure 186: Disconnecting the front USB connector

- ▶ Disconnect the front USB connector cable from the connector "TYPE A FRONT" on the system board (1).
- ▶ Disconnect the front USB connector cable from the connector "TYPE C FRONT" on the system board (2).

Removing the front USB connector from FBU tray

- ▶ Remove the FBU tray, see [Figure 130](#).

Front USB connector

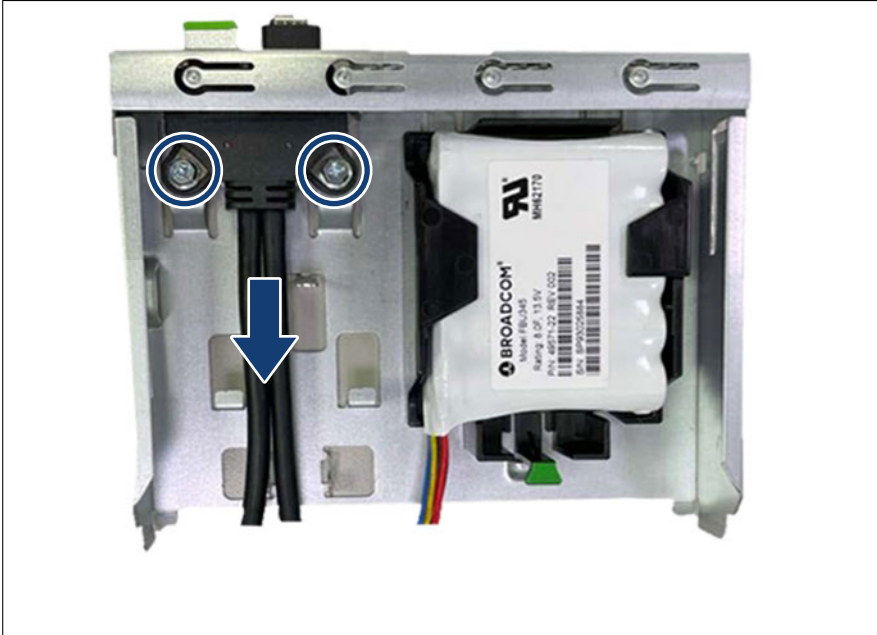

Figure 187: Removing the front USB connector

- ▶ Remove the two screws (see circles).
- ▶ Remove the front USB connector from the FBU tray.

Installing the FBU tray

- ▶ Install the FBU tray, see [Figure 138](#).

Concluding steps

- ▶ "Reassembling" on page 56.
- ▶ "Connecting the power cord" on page 59.
- ▶ "Switching on the server" on page 63.

14.3 Replacing a front USB connector



Upgrade and Repair Unit (URU)



Hardware: 10 minutes

Tools: Phillips PH2 / (+) No. 2 screw driver

Preliminary steps

- ▶ ["Locating the defective server" on page 45.](#)
- ▶ ["Shutting down the server" on page 47.](#)
- ▶ ["Disconnecting the power cord" on page 48.](#)
- ▶ ["Getting access to the component" on page 50.](#)

Removing the defective front USB connector

- ▶ Remove the front USB connector, see ["Removing the front USB connector from FBU tray" on page 287.](#)

Installing the new front USB connector

- ▶ Install the front USB connector, see ["Installing the front USB connector" on page 284.](#)

Concluding steps

- ▶ ["Reassembling" on page 56.](#)
- ▶ ["Connecting the power cord" on page 59.](#)
- ▶ ["Switching on the server" on page 63.](#)

15 Serial interface

15.1 Safety notes



CAUTION

▶ For more information, see ["Important information" on page 31](#).

15.2 Installing the serial interface



Upgrade and Repair Unit (URU)



Hardware: 5 minutes

Tools: <ul style="list-style-type: none">– Phillips PH2 / (+) No. 2 screw driver– Hexagon screw driver 5 mm

Preliminary steps

- ▶ ["Shutting down the server" on page 47](#).
- ▶ ["Disconnecting the power cord" on page 48](#).
- ▶ ["Getting access to the component" on page 50](#).

Breaking off the metal cover



Figure 188: Removing the metal cover

- ▶ Insert the screw driver to the hole and twist the metal cover until it breaks off (see close-up).
- ▶ Remove the metal cover.

Installing the serial interface

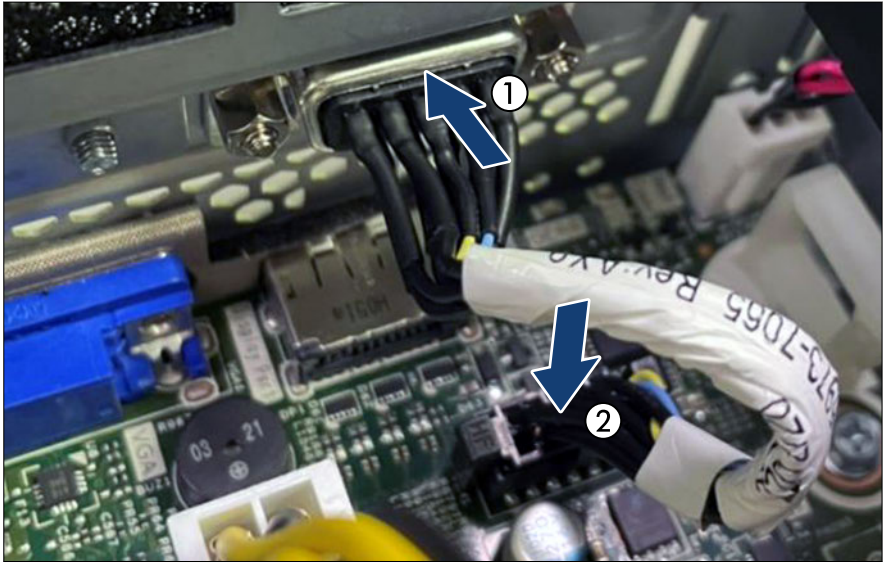

Figure 189: Installing the serial interface (A)

- ▶ Insert the serial interface into the slot (1).
- ▶ Connect the serial interface cable to the connector "SERIAL" on the system board (2).



Figure 190: Installing the serial interface (B)

- ▶ Fasten the serial interface with two hexagonal bolts (see circles).

Concluding steps

- ▶ "Reassembling" on page 56.
- ▶ "Connecting the power cord" on page 59.
- ▶ "Switching on the server" on page 63.

15.3 Removing the serial interface



Upgrade and Repair Unit (URU)



Hardware: 5 minutes

Tools: Hexagon screw driver 5 mm

Preliminary steps

- ▶ "Shutting down the server" on page 47.
- ▶ "Disconnecting the power cord" on page 48.
- ▶ "Getting access to the component" on page 50.

Removing the serial interface



Figure 191: Removing the serial interface (A)

- ▶ Remove the two hexagon bolts (see circles).

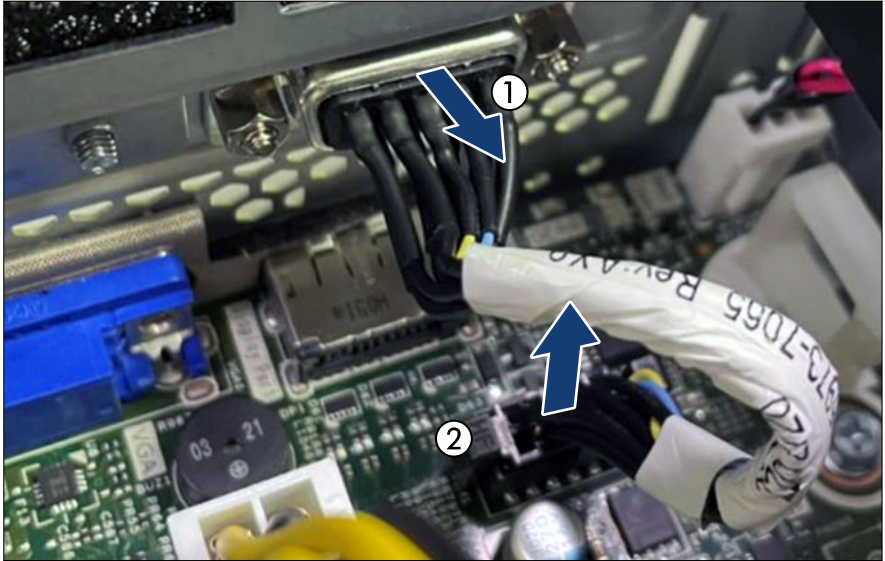

Figure 192: Removing the serial interface (B)

- ▶ Remove the serial interface (1).
- ▶ Disconnect the serial interface cable from the system board (2).

Concluding steps

- ▶ ["Reassembling" on page 56.](#)
- ▶ ["Connecting the power cord" on page 59.](#)
- ▶ ["Switching on the server" on page 63.](#)

15.4 Replacing the serial interface



**Upgrade and Repair Unit
(URU)**



Hardware: 5 minutes

Serial interface

Tools: Hexagon screw driver 5 mm

Preliminary steps

- ▶ ["Shutting down the server" on page 47.](#)
- ▶ ["Disconnecting the power cord" on page 48.](#)
- ▶ ["Getting access to the component" on page 50.](#)

Removing the defective serial interface

- ▶ Remove the serial interface, see ["Removing the serial interface" on page 294.](#)

Installing the new serial interface

- ▶ Install the serial interface, see ["Installing the serial interface" on page 293.](#)

Concluding steps

- ▶ ["Reassembling" on page 56.](#)
- ▶ ["Connecting the power cord" on page 59.](#)
- ▶ ["Switching on the server" on page 63.](#)

16 Dust cover

16.1 Safety notes



CAUTION

- ▶ Do not damage or modify internal cables or devices. Doing so may cause a device failure, fire, or electric shock.
- ▶ Devices and components inside the server remain hot after shutdown. After shutting down the server, wait for hot components to cool down before installing or removing internal options.
- ▶ Circuit boards and soldered parts of internal options are exposed and can be damaged by static electricity. Always discharge static build-up (e.g. by touching a grounded object) before handling electrostatic-sensitive devices (ESDs).
- ▶ Do not touch the circuitry on boards or soldered parts. Hold circuit boards by their metallic areas or edges.
- ▶ If devices are installed or disassembled using methods other than those outlined in this chapter, the warranty will be invalidated.
- ▶ For more information, see "[Important information](#)" on page 31.

16.2 Basic information

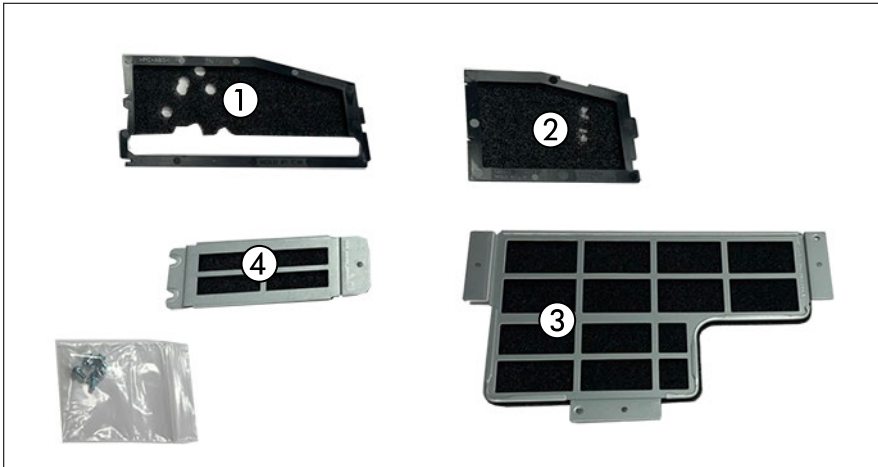

Figure 193: Dust cover kit

- | | | | |
|---|--------------|---|--------------|
| 1 | Dust cover 1 | 3 | Dust cover 3 |
| 2 | Dust cover 2 | 4 | Dust cover 4 |

16.3 Installing the dust covers



Upgrade and Repair Unit (URU)



Hardware: 15 minutes

Tools: Phillips PH2 / (+) No. 2 screw driver

Preliminary steps

- ▶ ["Shutting down the server" on page 47.](#)
- ▶ ["Disconnecting the power cord" on page 48.](#)
- ▶ ["Getting access to the component" on page 50.](#)

Installing the dust cover 1



Figure 194: Installing the dust cover 1

- ▶ Align the dust cover 1 with the HDD bay cover (see circle).
- ▶ Attach the dust cover 1 in a slight angle to the hdd bay cover.
- ▶ Press down the dust cover 1 until it snaps in.

Installing the dust cover 2

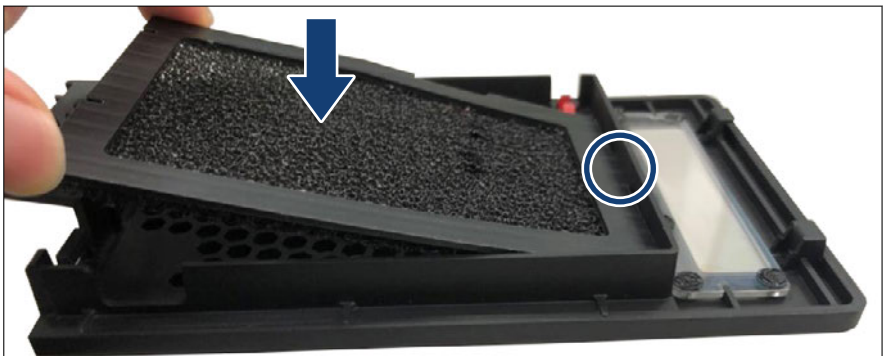

Figure 195: Installing the dust cover 2

- ▶ Align the dust cover 2 with the accessible drive bay cover (see circle).
- ▶ Attach the dust cover 2 in a slight angle to the accessible drive bay cover.
- ▶ Press down the dust cover 2 until it snaps in.

Dust cover

Installing the dust cover 3

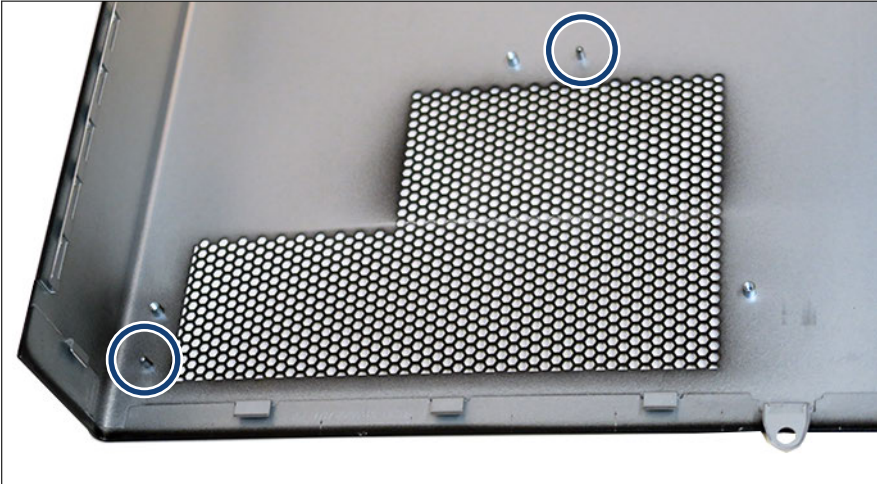

Figure 196: Installing the dust cover 3 (A)

- ▶ Install the dust cover 3 on the two guiding pins of the top cover (see circles).

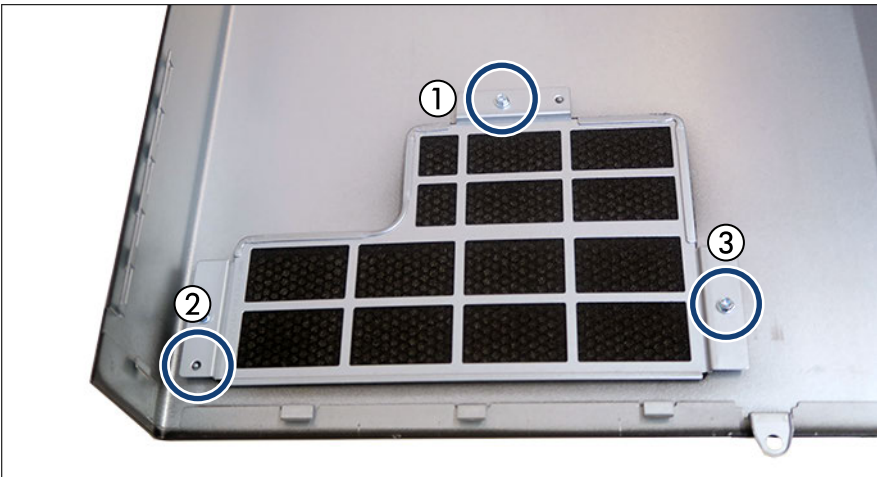

Figure 197: Installing the dust cover 3 (B)

- ▶ Fasten the three screws (see circles) in the specified order (1-3).

Installing the dust cover 4



Figure 198: Installing the dust cover 4 (A)

- Install the dust cover 4 on the two guiding pins of the top cover (see circles).



Figure 199: Installing the dust cover 4 (B)

- Fasten the screw (see circle).

Concluding steps

- ▶ ["Reassembling" on page 56.](#)
- ▶ ["Connecting the power cord" on page 59.](#)
- ▶ ["Switching on the server" on page 63.](#)
- ▶ Update the system information of your server using the Chassis ID Prom Tool, see ["Using the Chassis ID Prom Tool" on page 95.](#)

16.4 Removing the dust covers



Upgrade and Repair Unit (URU)



Hardware: 15 minutes

Tools: Phillips PH2 / (+) No. 2 screw driver

Preliminary steps

- ▶ ["Shutting down the server" on page 47.](#)
- ▶ ["Disconnecting the power cord" on page 48.](#)
- ▶ ["Getting access to the component" on page 50.](#)

Removing the dust cover 4



Figure 200: Removing the dust cover 4

- ▶ Remove the screw (see circle).
- ▶ Remove the dust cover 4 from the top cover.

Removing the dust cover 3

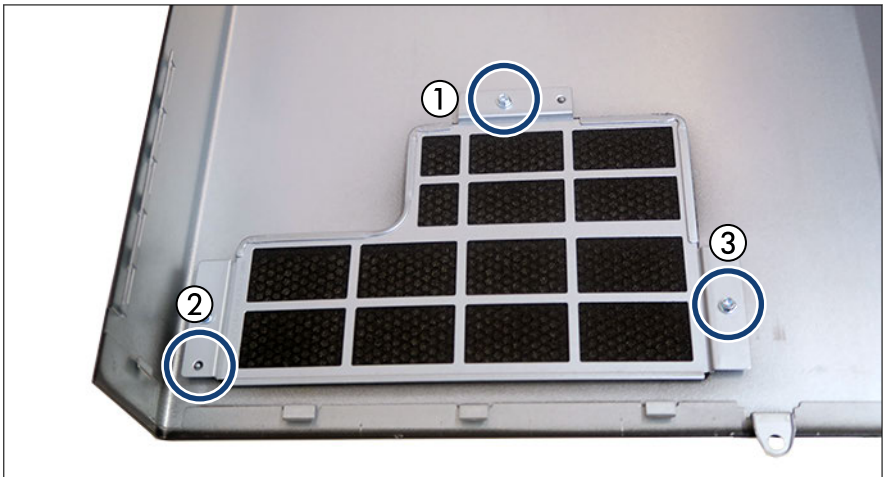

Figure 201: Removing the dust cover 3

Dust cover

- ▶ Remove the three screws (see circles) in the specified order (1-3).
- ▶ Remove the dust cover 3 from the top cover.

Removing the dust cover 2

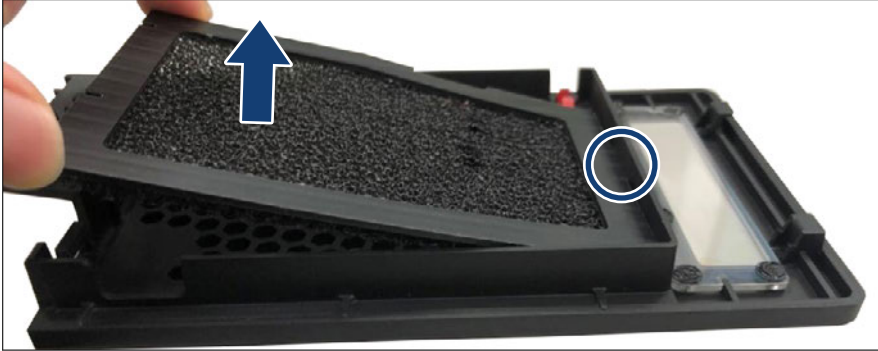

Figure 202: Removing the dust cover 2

- ▶ Remove dust cover 2 from the hook of the accessible drive bay cover (see circle).
- ▶ Remove the dust cover 2 in a slight angle from the accessible drive bay cover.

Removing the dust cover 1



Figure 203: Removing the dust cover 1

- ▶ Remove dust cover 1 from the hook of the HDD bay cover (see circle).
- ▶ Remove the dust cover 1 in a slight angle from the HDD bay cover.

Concluding steps

- ▶ ["Reassembling" on page 56.](#)
- ▶ ["Connecting the power cord" on page 59.](#)
- ▶ ["Switching on the server" on page 63.](#)

16.5 Replacing the dust covers



Upgrade and Repair Unit (URU)



Hardware: 15 minutes

Tools: Phillips PH2 / (+) No. 2 screw driver

Preliminary steps

- ▶ ["Shutting down the server" on page 47.](#)
- ▶ ["Disconnecting the power cord" on page 48.](#)
- ▶ ["Getting access to the component" on page 50.](#)

Removing the dust covers

- ▶ Remove the dust covers, see ["Removing the dust covers" on page 302.](#)

Installing the dust covers

- ▶ Install the dust covers, see ["Installing the dust covers" on page 298.](#)

Concluding steps

- ▶ ["Reassembling" on page 56.](#)
- ▶ ["Connecting the power cord" on page 59.](#)
- ▶ ["Switching on the server" on page 63.](#)

16.6 Cleaning the dust covers



Upgrade and Repair Unit (URU)



Hardware: 10 minutes

(Cleaning with a handy cleaner)



Hardware: 15 minutes

(Cleaning without a handy cleaner)

Tools: tool-less

Preliminary steps

- ▶ ["Shutting down the server" on page 47.](#)
- ▶ ["Disconnecting the power cord" on page 48.](#)
- ▶ If you do not have a handy cleaner, see ["Getting access to the component" on page 50.](#)



Do not wash the dust cover with water or liquid detergent.

- The dust covers should be cleaned every six months.
- Depending on your system configuration and system environment, cleaning may be required for less than six months if the contamination is severe.
- If the dust cover is very dirty or damaged, purchase a new dust cover. The dust cover replacement must be performed by a service person and is chargeable.
- The iRMC has a counter for the energization time and the SEL warning message `Dust cover lifetime is less than 1 month` is displayed in the iRMC S6 web interface at the fifth month.
- The SEL error message `Dust cover lifetime has been expired` appears on the iRMC S6 web interface at the sixth month. The CSS LED blinks.

- When the customer cleans the dust cover and resets the iRMC S6 web interface counters, the CSS LED turns off and the next six months are counted again.
- If the customer simply turns off the CSS LED manually by clicking **Suppress CSS warning** without cleaning the dust cover, the counter will continue to count. A warning message will appear again at the third month (ninth month).
- You cannot manually turn off the CSS LEDs at the third month (twelve months total energization) after the second warning message. Clean the dust cover and reset the counter.

Cleaning the dust covers

If you have a handy cleaner, proceed as follows:

- ▶ Remove dust from the dust cover 1 to the dust cover 4 with a handy cleaner.

If you do not have a handy cleaner, proceed as follows:

- ▶ Remove the dust cover 1, see ["Removing the dust cover 1" on page 304](#).
- ▶ Remove the dust cover 2, see ["Removing the dust cover 2" on page 304](#).
- ▶ Clean the dust cover 1 and the dust cover 2 with a dry cloth.
- ▶ Install the dust cover 2, see ["Installing the dust cover 2" on page 299](#).
- ▶ Install the dust cover 1, see ["Installing the dust cover 1" on page 299](#).

Concluding steps

- ▶ If you do not have a handy cleaner, see ["Reassembling" on page 56](#).
- ▶ ["Connecting the power cord" on page 59](#).
- ▶ ["Switching on the server" on page 63](#).
- ▶ Reset the counters in the iRMC S6 web interface, see ["Resetting the counter using the iRMC S6 web interface" on page 308](#)

Resetting the counter using the iRMC S6 web interface

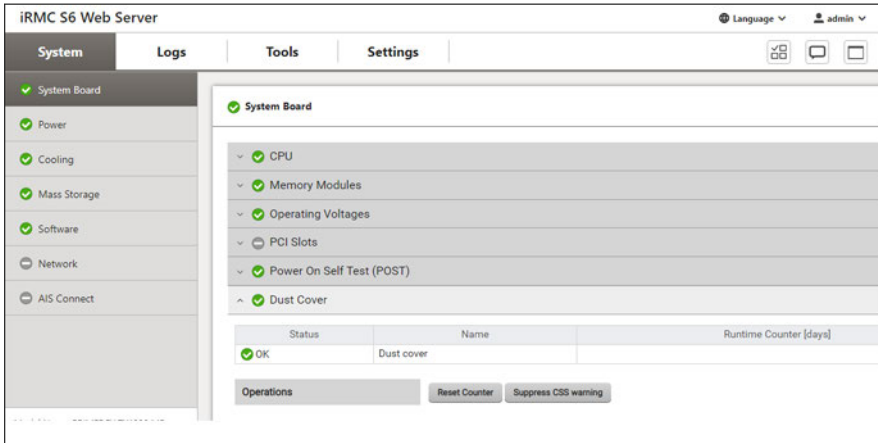

Figure 204: Resetting the counter

Proceed as follows:

- ▶ Enter the iRMC S6 web interface.
- ▶ Select the **System** menu.
- ▶ Open the **System Board** page.
- ▶ Select **Dust cover**.
- ▶ Click **Reset counter**.

17 System board and components

17.1 Safety notes



CAUTION

- ▶ Devices and components inside the server remain hot after shutdown. After shutting down the server, wait for hot components to cool down before installing or removing internal options.
- ▶ Circuit boards and soldered parts of internal options are exposed and can be damaged by static electricity. Always discharge static build-up (e.g. by touching a grounded object) before handling electrostatic-sensitive devices (ESDs).
- ▶ Do not touch the circuitry on boards or soldered parts. Hold circuit boards by their metallic areas or edges.
- ▶ For more information, see ["Important information" on page 31](#).

17.2 Basic information

This section provides instructions for the system board and the following components:

- CMOS battery (CR2032)

The real-time clock is powered by a lithium coin cell (CMOS battery) when mains get lost. This cell lasts up to five years, depending on ambient temperature and use.

If the CMOS battery is depleted or falls below minimum voltage levels, it need to be replaced immediately.

- TPM (Trusted Platform Module)

The system board is optionally equipped with a TPM. This module enables programs from third party manufacturers to store key information, for example drive encryption using Windows Bitlocker Drive Encryption.

System board and components

- iRMC microSD card

The iRMC microSD card is necessary for using the embedded Lifecycle Management (eLCM) functionality of the iRMC.

- M.2 SSD

The system board offers two M.2 slots (Key M) with support 80 mm and 110 mm long M.2 SSDs. With the M.2 SSD an internal SSD is offered. This SSD can be configured as a boot device or data storage device.

17.3 CMOS battery

17.3.1 Replacing the CMOS battery



Upgrade and Repair Unit (URU)



Hardware: 5 minutes

Tools: tool-less



For this server the battery type CR2032 is used.



CAUTION

- ▶ The CMOS battery must be replaced with an identical battery or with a battery type recommended by the manufacturer.
- ▶ Keep lithium batteries away from children.
- ▶ Do not throw batteries into the trash can. Lithium batteries must be disposed of in accordance with local regulations concerning special waste.
- ▶ For more safety information, see "Environmental protection" in the operating manual of your server.

Note on BIOS settings recovery



When replacing the CMOS battery, the BIOS settings will be reset.

Ensure to note down your current BIOS settings including **System Time** and **System date** before replacing the CMOS battery.

Preliminary steps

- ▶ ["Locating the defective server" on page 45.](#)
- ▶ ["Shutting down the server" on page 47.](#)
- ▶ ["Disconnecting the power cord" on page 48.](#)
- ▶ ["Getting access to the component" on page 50.](#)

Replacing the defective CMOS battery

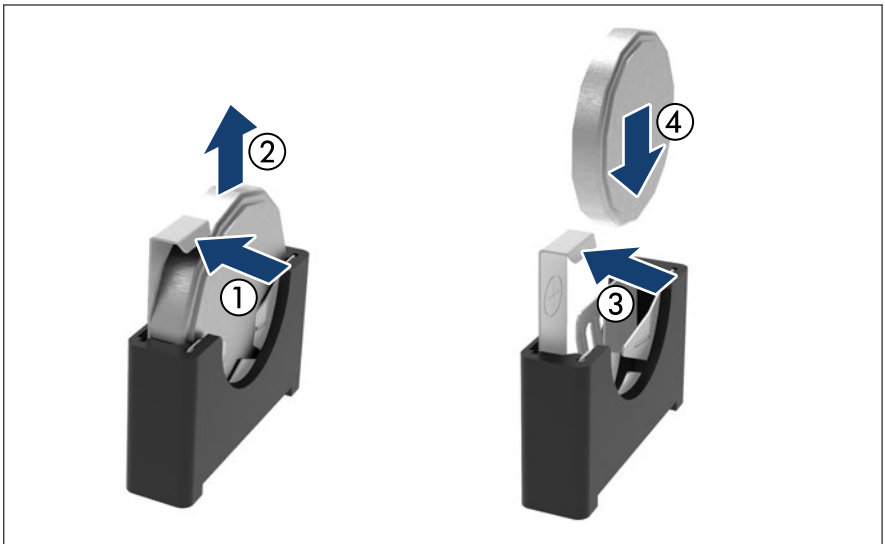

Figure 205: Replacing the CMOS battery

- ▶ Push the locking spring in direction of the arrow (1) and remove the CMOS battery out of its socket (2).
- ▶ Push the locking spring in direction of the arrow (3) and insert a new CMOS battery of the same type into the socket (4).

Concluding steps

- ▶ Dispose of the CMOS battery in accordance with local regulations concerning special waste.
- ▶ ["Reassembling"](#) on page 56.
- ▶ ["Connecting the power cord"](#) on page 59.
- ▶ ["Switching on the server"](#) on page 63.
- ▶ BIOS settings are automatically reloaded. Time and date must be set manually, see ["Verifying the system time settings"](#) on page 86.



You must manually change the BIOS settings according to the note on your current BIOS settings, see ["Note on BIOS settings recovery"](#) on page 311.

17.4 Trusted Platform Module (TPM)

17.4.1 Position of the TPM

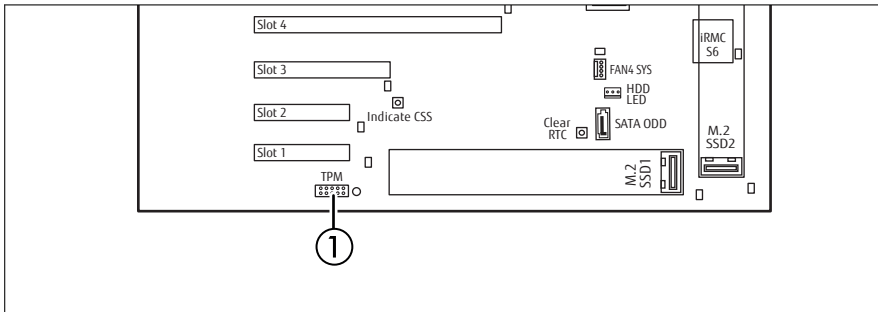

Figure 206: Position of the TPM on the system board

1 TPM

17.4.2 TPM kit

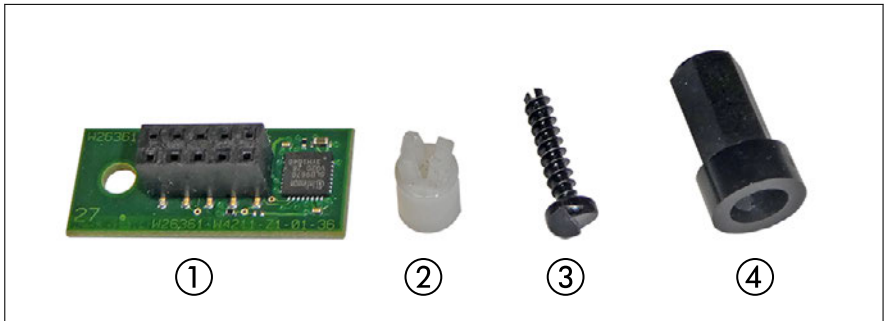

Figure 207: TPM installation kit

- | | | | |
|---|------------|---|--------------------------------------|
| 1 | TPM | 3 | Special screw for TPM |
| 2 | TPM spacer | 4 | TPM bit insert for TPM special screw |

17.4.3 Installing the TPM



Field Replaceable Unit (FRU)



Hardware: 5 minutes
Software: 5 minutes

- Tools:**
- Bit screw driver
 - TPM bit insert (*)
- (*)For Japan:
- TPM module fixing tool (S26361-F3552-L909)

Preliminary steps

- ▶ ["Suspending BitLocker functionality" on page 73.](#)
- ▶ ["Shutting down the server" on page 47.](#)
- ▶ ["Disconnecting the power cord" on page 48.](#)
- ▶ ["Getting access to the component" on page 50.](#)

Installing the TPM

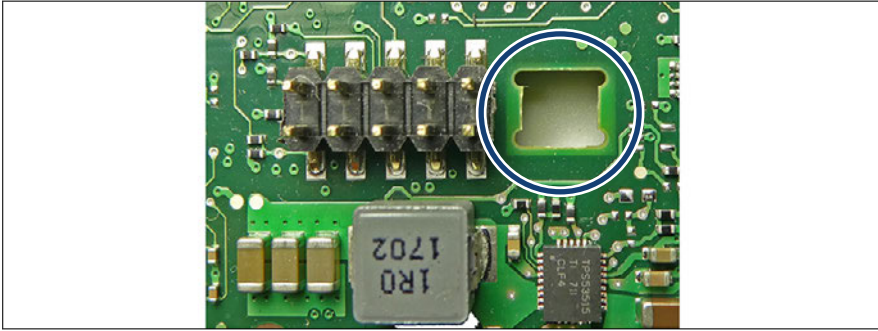

Figure 208: Position for the TPM spacer

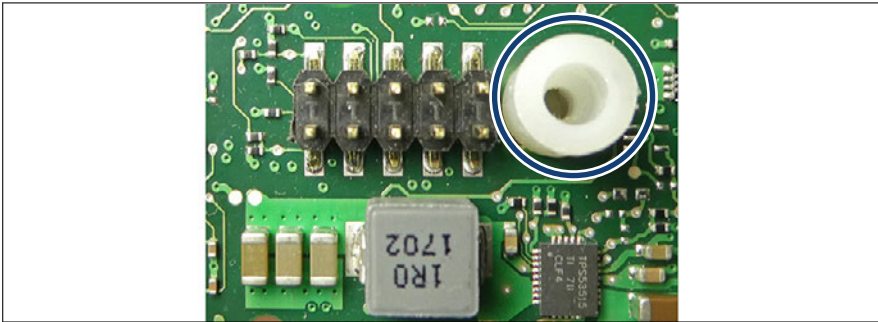

Figure 209: Inserting the TPM spacer on the system board

- ▶ Insert the TPM spacer into the hole on the system board.



Figure 210: TPM bit insert

- ▶ Attach the TPM bit insert or TPM module fixing tool (for Japan) to a bit screw driver.

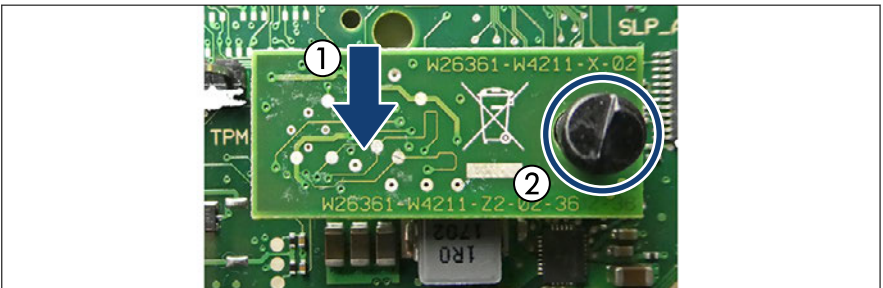

Figure 211: Installing the TPM

- ▶ Connect the TPM to the system board (1).
- ▶ Fasten the TPM with the special screw for the TPM using the TPM bit insert or TPM module fixing tool (Japan) (2).



CAUTION

- ▶ Do not fasten the screw too firmly.
- ▶ Stop it by extent where the head of the screw lightly touches the TPM. Torque: 0.6 Nm (not used in Japan).

Concluding steps

- ▶ "Reassembling" on page 56.
- ▶ "Connecting the power cord" on page 59.
- ▶ "Switching on the server" on page 63.
- ▶ "Resuming BitLocker functionality" on page 90.

Enabling the TPM in the system board BIOS

Proceed as follows:

- ▶ Switch on or restart your server.
- ▶ As soon as the startup screen appears, press the [F2] function key to enter the BIOS setup menu.
- ▶ Select the **Advanced** menu.
- ▶ Select the **Trusted Computing** submenu.
- ▶ Set the **TPM Support** and **TPM State** settings to **Enabled**.
- ▶ Under **Pending TPM operation**, select the desired TPM operation mode.
- ▶ Save your changes and exit the BIOS.



For information on how to access the BIOS and modify settings, see the corresponding BIOS Setup Utility reference manual.

17.4.4 Removing the TPM



Field Replaceable Unit (FRU)



Hardware: 30 minutes

Tools: Removing the system board:

- Phillips PH2 / (+) No. 2 screw driver

Removing the TPM:

- Bit screw driver
- flat nose pliers
- TPM bit insert (*)

(*) For Japan:

- TPM module fixing tool (S26361-F3552-L909)



CAUTION

- Advise your contact persons that they must provide you with all recovery keys which belong to the system to restore them in the TPM later.

Preliminary steps



Preliminary steps are not necessary, if a system board has to be replaced and the TPM is used again.

Removing BitLocker protection and decrypting the volume

- ▶ Before removing the TPM board, it is necessary to remove BitLocker protection from the computer and to decrypt the volume. Ask the system administrator to turn off BitLocker protection using the BitLocker setup wizard available either from the Control Panel or Windows Explorer:
 - ▶ Open Bitlocker Drive Encryption by clicking the **Start** button, clicking **Control Panel**, clicking **Security**, and then clicking **Bitlocker Drive Encryption**.



Administrator permission required: If you are prompted for an administrator password or confirmation, type the password or provide confirmation.

- ▶ To turn off BitLocker and decrypt the volume, click **Turn Off BitLocker**, and then click **Decrypt the volume**.



Decrypting the volume may be time-consuming. By decrypting the volume, all of the information stored on that computer is decrypted.

For more information on how to disable BitLocker drive encryption, see the Microsoft Knowledge Base. See the Fujitsu web pages for more details.

Disabling the TPM in the system board BIOS

Proceed as follows:

- ▶ Switch on or restart your server.
- ▶ As soon as the startup screen appears, press the [F2] function key to enter the BIOS setup menu.
- ▶ Select the **Advanced** menu.
- ▶ Select the **Trusted Computing** submenu.
- ▶ Set the **TPM Support** and **TPM State** settings to **Disabled**.
- ▶ Save your changes and exit the BIOS.



For information on how to access the BIOS and modify settings, see the corresponding BIOS Setup Utility reference manual.

- ▶ "Suspending BitLocker functionality" on page 73.
- ▶ "Shutting down the server" on page 47.
- ▶ "Disconnecting the power cord" on page 48.
- ▶ "Getting access to the component" on page 50.

Removing the TPM

- ▶ Remove the system board, see ["Removing the defective system board" on page 353](#).
- ▶ Lay the system board on a soft, antistatic surface with its component side facing down.

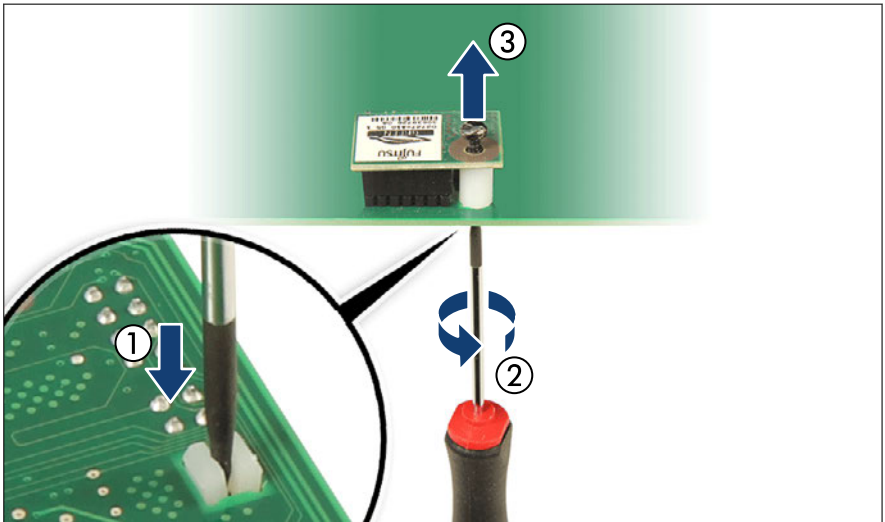

Figure 212: Removing the TPM screw

System board and components

- ▶ Locate the slotted lower end of the TPM screw (1).
- ▶ Carefully loosen the TPM screw using a thin slotted screw driver (e.g. watchmaker's screw driver) or the dedicated TPM screw driver (Japan) (2).



CAUTION

- ▶ Ensure to turn the screw **clockwise** in order to remove it.
 - ▶ Slowly and carefully increase the pressure on the screw until it begins to turn. The effort when loosening the screw should be as low as possible.

Otherwise the thin metal bar may break, rendering it impossible to loosen the screw.
- ▶ Remove the TPM screw (3).
 - ▶ Remove the TPM on the upper side of the system board.

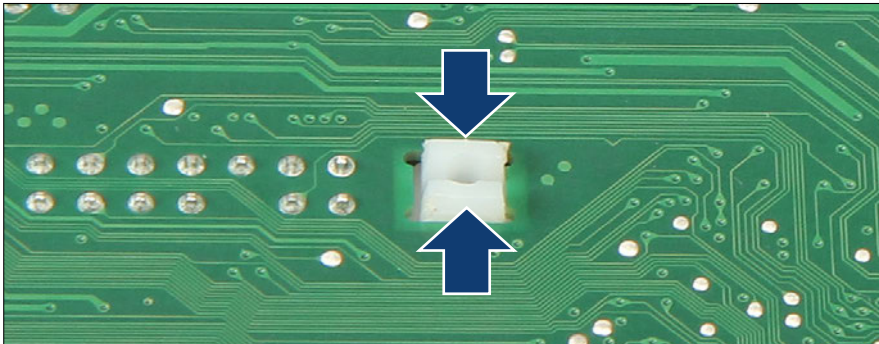

Figure 213: Removing the TPM spacer

- ▶ Using a flat nose pliers, press together the hooks on the TPM spacer and remove it from the system board (2).



If the TPM is to be replaced, the TPM spacer may remain on the system board.

- ▶ Install the system board, see ["Installing the new system board" on page 356](#).

Concluding steps

- ▶ ["Reassembling" on page 56.](#)
- ▶ ["Connecting the power cord" on page 59.](#)
- ▶ ["Switching on the server" on page 63.](#)

17.4.5 Replacing the TPM



Field Replaceable Unit (FRU)



Hardware: 40 minutes

- Tools:** Removing the system board:
- Phillips PH2 / (+) No. 2 screw driver
- Replacing the TPM:
- Bit screw driver
 - TPM bit insert (*)
 - flat nose pliers
 - thin slotted screw driver (2 x 0.4 mm)(*)
- (*)For Japan:
- Dedicated TPM screw driver (CWZ8291A)
 - TPM module fixing tool (S26361-F3552-L909)



CAUTION

- ▶ Advise your contact persons that they must provide you with all recovery keys which belong to the system to restore them in the TPM later.

Preliminary steps

- ▶ ["Locating the defective server" on page 45.](#)
- ▶ ["Suspending BitLocker functionality" on page 73.](#)

System board and components

- ▶ ["Shutting down the server" on page 47.](#)
- ▶ ["Disconnecting the power cord" on page 48.](#)
- ▶ ["Getting access to the component" on page 50.](#)
- ▶ ["Removing the defective system board" on page 353.](#)

Removing the defective TPM

- ▶ Remove the TPM, see ["Removing the TPM" on page 319.](#)
- ▶ Leave the TPM spacer on the system board when removing the defective TPM.

Installing the new TPM



The TPM spacer is already present on the system board.

- ▶ Install the TPM, see ["Installing the TPM" on page 314.](#)

Concluding steps

- ▶ Install the system board, see ["Installing the new system board" on page 356.](#)
- ▶ ["Reassembling" on page 56.](#)
- ▶ ["Connecting the power cord" on page 59.](#)
- ▶ ["Switching on the server" on page 63.](#)
- ▶ ["Resuming BitLocker functionality" on page 90.](#)



You can find information on configuring the TPM in the corresponding BIOS Setup Utility reference manual.

17.5 iRMC microSD card

17.5.1 Note for embedded Lifecycle Management (eLCM)



The iRMC microSD card is necessary for using the embedded Lifecycle Management (eLCM) functionality of the iRMC. It requires a valid eLCM license key from user purchase order and activated through the iRMC web interface.

For more information, see the “ServerView embedded Lifecycle Management (eLCM)” user guide.

17.5.2 Installing the iRMC microSD card



Upgrade and Repair Unit (URU)



Hardware: 5 minutes

Tools: tool-less

Preliminary steps

- ▶ ["Shutting down the server" on page 47.](#)
- ▶ ["Disconnecting the power cord" on page 48.](#)
- ▶ ["Getting access to the component" on page 50.](#)

Installing the iRMC microSD card



Figure 214: iRMC microSD card

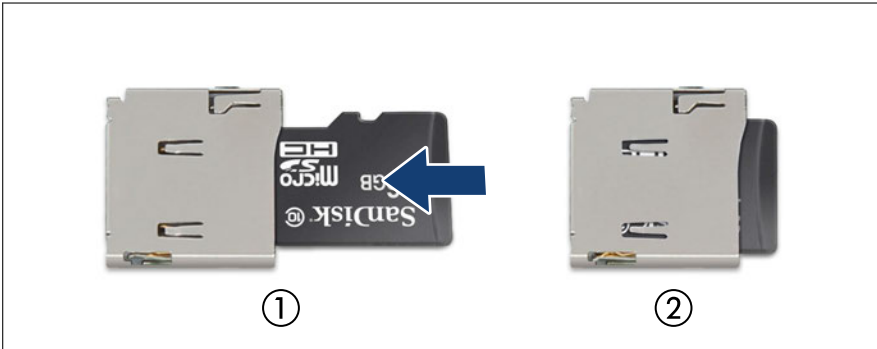

Figure 215: Installing the iRMC microSD card

- ▶ With the label facing up, insert the iRMC microSD card into the microSD card slot (1) until it locks in place (2).



The onboard position of the microSD card slot can be found in ["Connectors and indicators on the system board"](#) on page 368.

Concluding steps

- ▶ ["Reassembling"](#) on page 56.
- ▶ ["Connecting the power cord"](#) on page 59.
- ▶ ["Switching on the server"](#) on page 63.

17.5.3 Removing the iRMC microSD card



Upgrade and Repair Unit
(URU)



Hardware: 5 minutes

Tools: tool-less

Preliminary steps

- ▶ "Shutting down the server" on page 47.
- ▶ "Disconnecting the power cord" on page 48.
- ▶ "Getting access to the component" on page 50.

Removing the iRMC microSD card

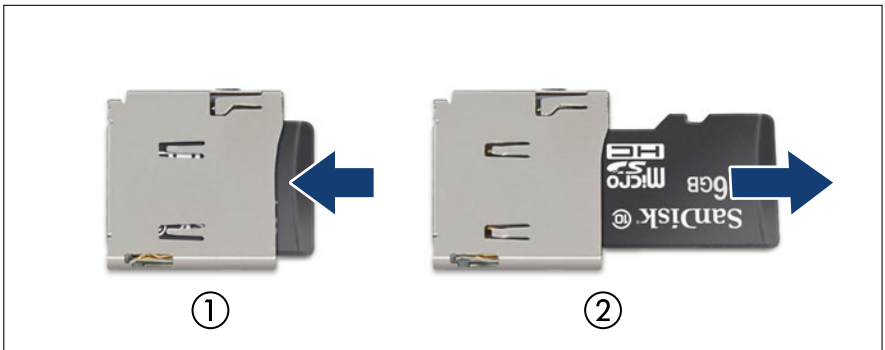

Figure 216: Removing the iRMC microSD card

System board and components

- ▶ To eject the iRMC microSD card, gently push it in and then let go (1).
- ▶ Pull the iRMC microSD card straight out of its slot (2).



CAUTION

(not valid for Europe, Middle East, India and Africa)

The iRMC microSD card contains customer information.

- ▶ After removing the iRMC microSD card, hand the card over to the customer.
- ▶ If the customer requests disposal of the defective microSD card, proceed as follows: Using a pair of side-cutting pliers, cut the microSD card in half.

Concluding steps

- ▶ ["Reassembling" on page 56.](#)
- ▶ ["Connecting the power cord" on page 59.](#)
- ▶ ["Switching on the server" on page 63.](#)

17.5.4 Replacing the iRMC microSD card



Upgrade and Repair Unit (URU)



Hardware: 5 minutes

(Firmware automatic version adjustment: depending on configuration)

Tools: a pair of side-cutting pliers

Preliminary steps

- ▶ ["Locating the defective server" on page 45.](#)
- ▶ ["Shutting down the server" on page 47.](#)
- ▶ ["Disconnecting the power cord" on page 48.](#)
- ▶ ["Getting access to the component" on page 50.](#)

Replacing the iRMC microSD card

- ▶ Remove the defective iRMC microSD card, see ["Removing the iRMC microSD card" on page 325](#).



CAUTION

(not valid for Europe, Middle East, India and Africa)

The iRMC microSD card contains customer information.

- ▶ After removing the iRMC microSD card, hand the card over to the customer.
 - ▶ If the customer requests disposal of the defective microSD card, proceed as follows: Using a pair of side-cutting pliers, cut the microSD card in half.
- ▶ Install the new iRMC microSD card, see ["Installing the iRMC microSD card" on page 323](#).

Concluding steps

- ▶ ["Reassembling" on page 56](#).
- ▶ ["Connecting the power cord" on page 59](#).
- ▶ Update the BIOS, see ["Updating the BIOS" on page 327](#).
- ▶ ["Switching on the server" on page 63](#).

Updating the BIOS



This operation will save the firmware image used for firmware restore function to the iRMC microSD card after replacing the system board.

► Update the BIOS.

Use the currently running firmware version.



For updates using a bootable USB stick or ASP, the firmware is not saved to the iRMC microSD card.

► After the update is completed, check the SEL log files to verify if the update was successful.

If the update is successfully completed, the following messages will be recorded.

<iRMC>

A backup of iRMC Firmware%1 has been successfully created on SD card.

<BIOS>

BIOS backup to SD card succeeded.

If the update fails and is not saved to the iRMC microSD card, a SEL stating that it failed will be recorded.



Even if an error occurs during the saving process, the BIOS backup image already saved on the iRMC microSD will not be lost.

17.6 M.2 SSD

17.6.1 Slots and bolts for M.2 SSDs

The system board offers two M.2 slots (Key M) with support for 80 mm and 110 mm long M.2 SSDs.



Figure 217: Example M.2 SSD

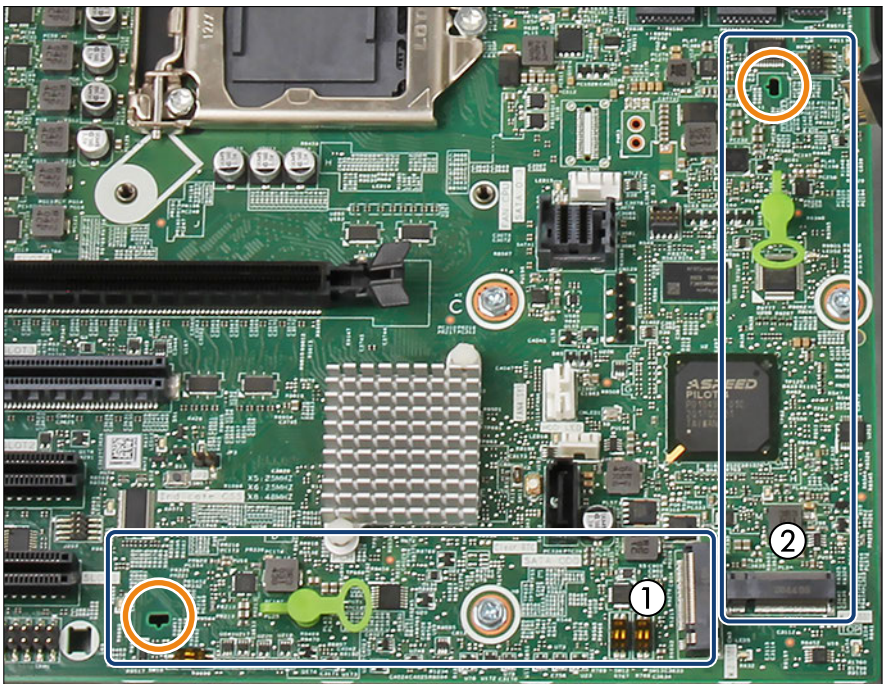

Figure 218: Slots and bolts for M.2 SSDs

1 M.2 slot 1

2 M.2 slot 2



The second hole is for M.2 SSDs with 110 mm length (see orange circles). If necessary, move the M.2 lock to the second hole, see ["Moving the M.2 lock to the second hole" on page 330](#).

17.6.2 Installing an M.2 SSD



Upgrade and Repair Unit (URU)



Hardware: 5 minutes
Software: 15 minutes

Tools: tool-less

Preliminary steps

- ▶ ["Checking boot priority" on page 77](#).
- ▶ ["Shutting down the server" on page 47](#).
- ▶ ["Disconnecting the power cord" on page 48](#).
- ▶ ["Getting access to the component" on page 50](#).
- ▶ If applicable, remove an expansion card, see ["Removing expansion cards" on page 210](#).
- ▶ If applicable, remove the HDD fan module (2.5-inch HDD variant), see ["Removing the HDD fan module \(2.5-inch HDD variant\)" on page 70](#).
- ▶ If applicable, remove the NVMe cables from the PCIe backplane, see [Figure 86](#).

Moving the M.2 lock to the second hole



This step is only necessary when installing M.2 SSDs with 110 mm length.

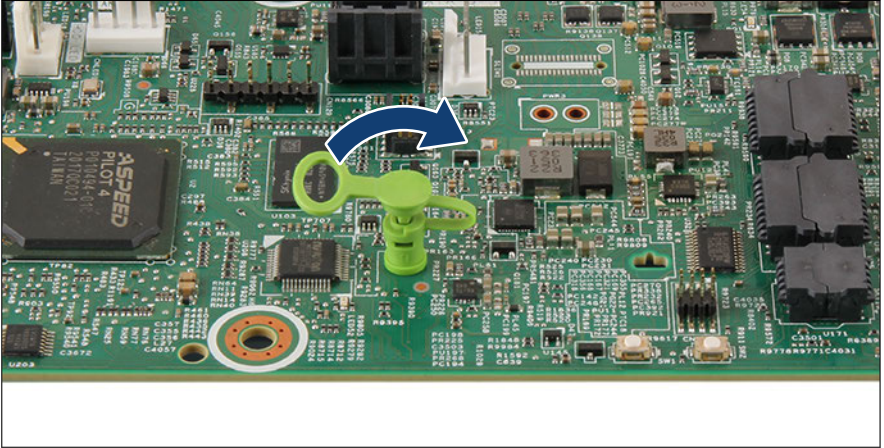

Figure 219: Removing the M.2 lock (A)

- Open the M.2 lock.

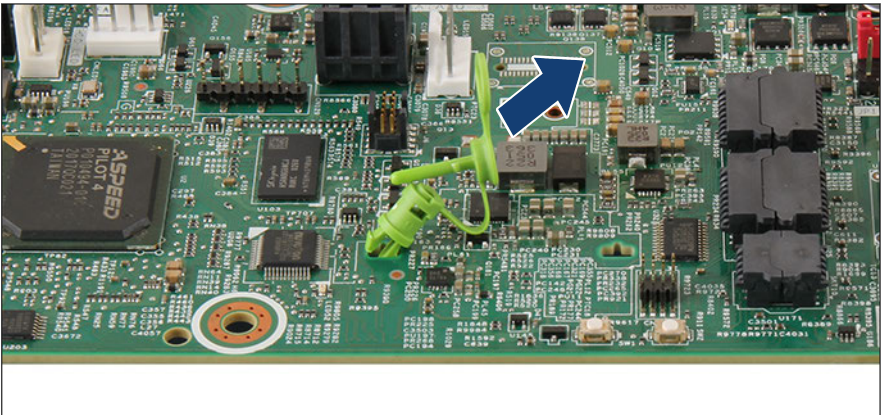

Figure 220: Removing the M.2 lock (B)

- Pull out the M.2 lock in direction of the arrow.

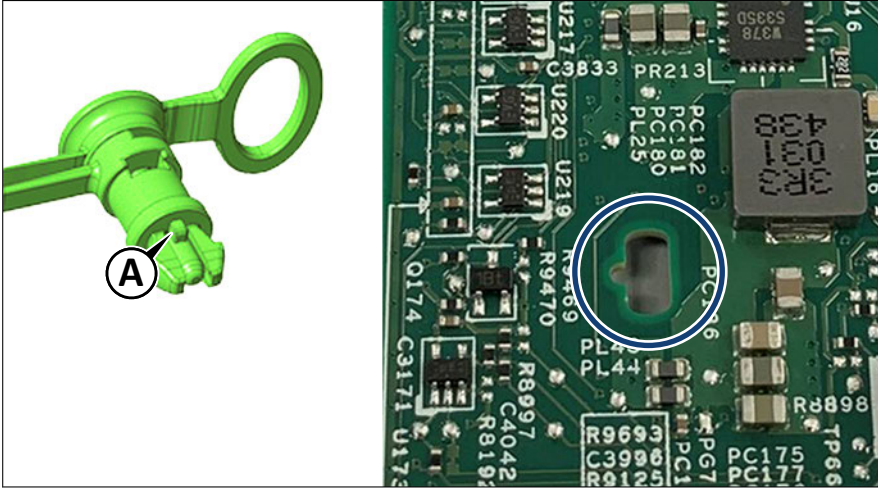

Figure 221: Inserting the M.2 lock

- ▶ Insert the M.2 lock in the second hole (see circle).



The M.2 lock has a pin (A) to ensure right insertion.

Installing the M.2 SSD



CAUTION

An M.2 SSD in M.2 slot 2 is not recognized, if M.2 slot 1 is free.

- ▶ The M.2 slot 1 must be equipped first.

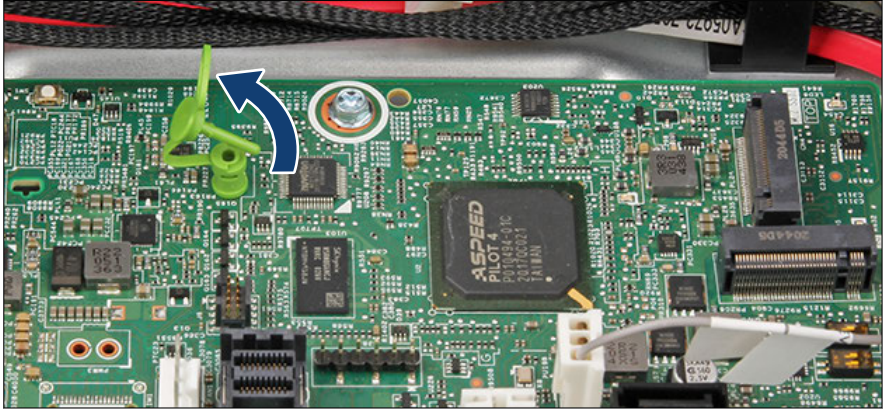

Figure 222: Opening the M.2 lock

- Open the M.2 lock.



Figure 223: Installing the M.2 SSD (A)

- With the label facing up, insert the M.2 SSD into the M.2 slot at a slight angle (1).
- Place the M.2 SSD on the M.2 lock (2).

System board and components



Figure 224: Installing the M.2 SSD (B)

- ▶ Close the M.2 lock to fasten the M.2 SSD.

Concluding steps

- ▶ If applicable, install the NVMe cables from the PCIe backplane, see [Figure 87](#).
- ▶ If applicable, install the HDD fan module (2.5-inch HDD variant), see ["Installing the HDD fan module \(2.5-inch HDD variant\)" on page 71](#).
- ▶ If applicable, install an expansion card, see ["Installing expansion cards" on page 199](#).
- ▶ ["Reassembling" on page 56](#).
- ▶ ["Connecting the power cord" on page 59](#).
- ▶ ["Switching on the server" on page 63](#).
- ▶ ["Setting boot priority" on page 100](#).

Software configuration

In order to install the ESXi to the M.2 SSD, the VMware ESXi installer CD is required. To obtain the ESXi installer CD by purchasing the OEM Media Kit, or downloading the ESXi Custom Image ISO file from the VMware website and burn the image to the CD.

<https://www.vmware.com/go/download-vsphere>

Install the ESXi to the M.2 SSD by following the steps below:

- ▶ Disconnect all storage devices from the server beside the M.2 SSD.
- ▶ Power on the server. Once the server has been started, then enter the BIOS setup menu and select the DVD drive as primary boot device.
- ▶ Insert the CD into the DVD drive and reboot the server. The server will boot from the installer CD.
- ▶ Follow the on-screen instructions to install the ESXi. When the installation is complete, you will be asked to reboot the server.
- ▶ While the server is rebooting, enter the BIOS setup menu again and select the M.2 SSD as primary boot device.

The installation of the ESXi to the M.2 SSD is complete.



For more information on how to access the BIOS and modify settings, see the corresponding BIOS Setup Utility reference manual.



The M.2 SSD can be used only for boot device. Do not use VMFS on the M.2 SSD because of not meeting required endurance. For more information, see the VMware Knowledge Base 2145210.

<https://kb.vmware.com/s/article/2145210>



For Japan

In order to setup the ESXi, see the corresponding version of the "VMware vSphere Software Description" from the following URL and reinstall ESXi to the M.2 SSD.

<https://jp.fujitsu.com/platform/server/primergy/software/vmware/manual/>

17.6.3 Removing an M.2 SSD



Upgrade and Repair Unit (URU)



Hardware: 5 minutes

Tools: tool-less

Preliminary steps

- ▶ "Shutting down the server" on page 47.
- ▶ "Disconnecting the power cord" on page 48.
- ▶ "Getting access to the component" on page 50.
- ▶ If applicable, remove an expansion card, see "Removing expansion cards" on page 210.
- ▶ If applicable, remove the HDD fan module (2.5-inch HDD variant), see "Removing the HDD fan module (2.5-inch HDD variant)" on page 70.
- ▶ If applicable, remove the NVMe cables from the PCIe backplane, see Figure 86.

Removing the M.2 SSD



Figure 225: Removing the M.2 SSD (A)

- ▶ Open the M.2 lock.



Figure 226: Removing the M.2 SSD (B)

- ▶ Remove the M.2 SSD out of the M.2 lock (1).
- ▶ Remove the M.2 SSD out of the M.2 SSD slot in direction of the arrow (2).



Figure 227: Closing the M.2 lock

- ▶ Close the M.2 lock.

Concluding steps

- ▶ If applicable, install the NVMe cables from the PCIe backplane, see [Figure 87](#).
- ▶ If applicable, install the HDD fan module (2.5-inch HDD variant), see ["Installing the HDD fan module \(2.5-inch HDD variant\)" on page 71](#).
- ▶ If applicable, install an expansion card, see ["Installing expansion cards" on page 199](#).
- ▶ ["Reassembling" on page 56](#).
- ▶ ["Connecting the power cord" on page 59](#).
- ▶ ["Switching on the server" on page 63](#).

17.6.4 Replacing an M.2 SSD



**Upgrade and Repair Unit
(URU)**



**Hardware: 5 minutes
Software: 15 minutes**

Tools: tool-less

Preliminary steps

- ▶ ["Locating the defective server" on page 45](#).
- ▶ ["Checking boot priority" on page 77](#).
- ▶ ["Shutting down the server" on page 47](#).
- ▶ ["Disconnecting the power cord" on page 48](#).
- ▶ ["Getting access to the component" on page 50](#).
- ▶ If applicable, remove an expansion card, see ["Removing expansion cards" on page 210](#).
- ▶ If applicable, remove the HDD fan module (2.5-inch HDD variant), see ["Removing the HDD fan module \(2.5-inch HDD variant\)" on page 70](#).
- ▶ If applicable, remove the NVMe cables from the PCIe backplane, see [Figure 86](#).

Replacing the M.2 SSD

- ▶ Remove the defective M.2 SSD, see ["Removing an M.2 SSD" on page 335](#).
- ▶ Install the new M.2 SSD, see ["Installing an M.2 SSD" on page 330](#).

Concluding steps

- ▶ If applicable, install the NVMe cables from the PCIe backplane, see [Figure 87](#).
- ▶ If applicable, install the HDD fan module (2.5-inch HDD variant), see ["Installing the HDD fan module \(2.5-inch HDD variant\)" on page 71](#).
- ▶ If applicable, install an expansion card, see ["Installing expansion cards" on page 199](#).
- ▶ ["Reassembling" on page 56](#).
- ▶ ["Connecting the power cord" on page 59](#).
- ▶ ["Switching on the server" on page 63](#).
- ▶ ["Setting boot priority" on page 100](#).

Software configuration



To install the ESXi to the M.2 SSD, see ["Software configuration" on page 334](#).

17.7 Dual microSD 64GB Enterprise

17.7.1 Position of the Dual microSD 64GB Enterprise

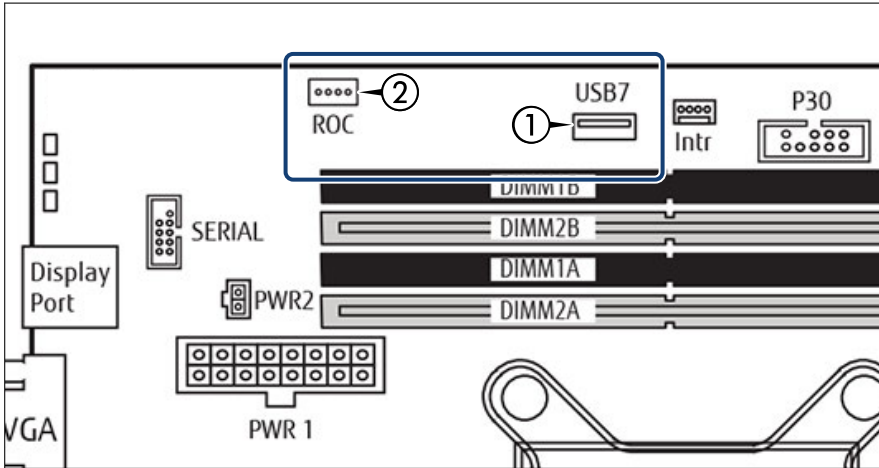

Figure 228: Position on the system board

1 Dual microSD 64GB connector

2 Connector for cable

17.7.2 Installing the Dual microSD 64GB Enterprise



Upgrade and Repair Unit (URU)



Hardware: 5 minutes

Tools: tool-less

Preliminary steps

- ▶ ["Checking boot priority" on page 77.](#)
- ▶ ["Shutting down the server" on page 47.](#)
- ▶ ["Disconnecting the power cord" on page 48.](#)
- ▶ ["Getting access to the component" on page 50.](#)

Installing the Dual microSD 64GB Enterprise

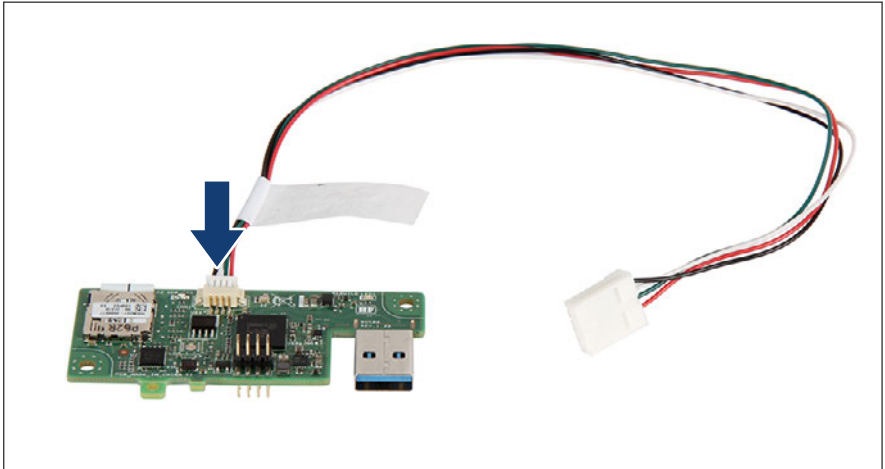

Figure 229: Connecting the cable to the Dual microSD 64GB Enterprise

- ▶ Connect the cable to the Dual microSD 64GB Enterprise.

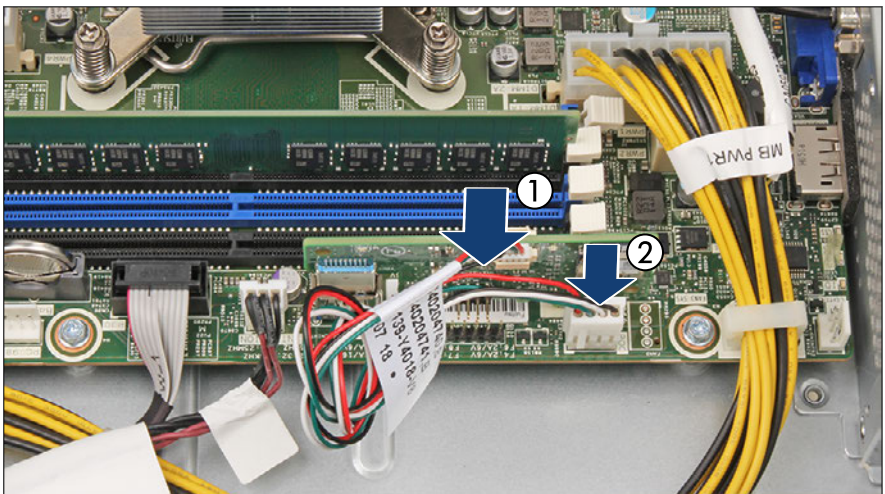

Figure 230: Installing the Dual microSD 64GB Enterprise

- ▶ Install the Dual microSD 64GB Enterprise into the connector "USB 7" (1).
- ▶ Connect the ROC cable to the connector "ROC" (2).



For the connectors "USB 7" and "ROC", see [Figure 228](#).

Concluding steps

- ▶ "Reassembling" on page 56.
- ▶ "Connecting the power cord" on page 59.
- ▶ "Switching on the server" on page 63.
- ▶ "Setting boot priority" on page 100.

Software configuration

In order to install the ESXi to the Dual microSD 64GB Enterprise, the VMware ESXi installer CD is required. To obtain the ESXi installer CD by purchasing the OEM Media Kit, or downloading the ESXi Custom Image ISO file from the VMware website and burn the image to the CD.

<https://www.vmware.com/go/download-vmware>

Install the ESXi to the Dual microSD 64GB Enterprise by following the steps below:

- ▶ Disconnect all storage devices from the server beside the Dual microSD 64GB Enterprise.
- ▶ Power on the server. Once the server has been started, then enter the BIOS setup menu and select the DVD drive as primary boot device.
- ▶ Insert the CD into the DVD drive and reboot the server. The server will boot from the installer CD.
- ▶ Follow the on-screen instructions to install the ESXi. When the installation is complete, you will be asked to reboot the server.
- ▶ While the server is rebooting, enter the BIOS setup menu again and select the Dual microSD 64GB Enterprise as primary boot device.

The installation of the ESXi to the Dual microSD 64GB Enterprise is complete.



For more information on how to access the BIOS and modify settings, see the corresponding BIOS Setup Utility reference manual.



The Dual microSD 64GB Enterprise can be used only for boot device. Do not use VMFS on the Dual microSD 64GB Enterprise because of not meeting required endurance. For more information, see the VMware Knowledge Base 2145210.

<https://kb.vmware.com/s/article/2145210>



For Japan

In order to setup the ESXi, see the corresponding version of the "VMware vSphere Software Description" from the following URL and reinstall ESXi to the Dual microSD 64GB Enterprise.

<https://jp.fujitsu.com/platform/server/primergy/software/vmware/manual/>

17.7.3 Removing the Dual microSD 64GB Enterprise



Upgrade and Repair Unit (URU)



Hardware: 5 minutes

Tools: tool-less

Preliminary steps

- ▶ ["Shutting down the server" on page 47.](#)
- ▶ ["Disconnecting the power cord" on page 48.](#)
- ▶ ["Getting access to the component" on page 50.](#)

Removing the Dual microSD 64GB Enterprise

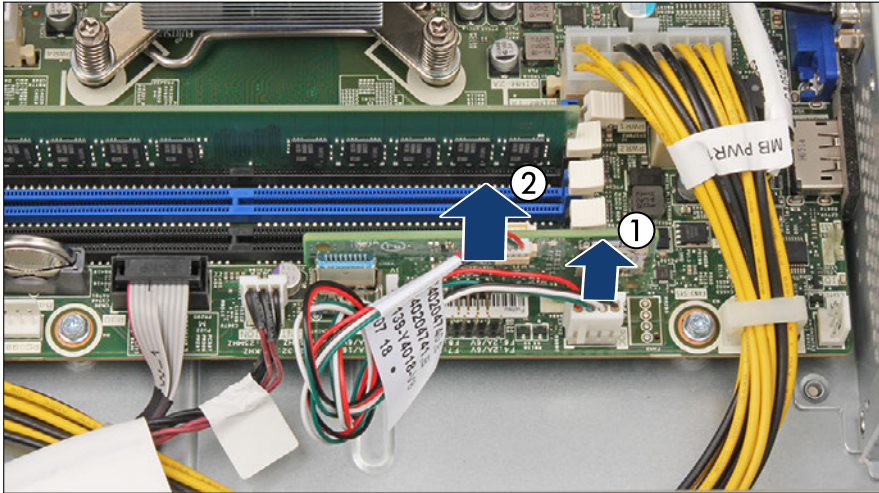

Figure 231: Removing the Dual microSD 64GB Enterprise

- ▶ Disconnect the ROC cable from the connector "ROC" (1).
- ▶ Remove the Dual microSD 64GB Enterprise from the connector "USB 7" (2).

Concluding steps

- ▶ ["Reassembling" on page 56.](#)
- ▶ ["Connecting the power cord" on page 59.](#)
- ▶ ["Switching on the server" on page 63.](#)

17.7.4 Replacing the Dual microSD 64GB Enterprise



Upgrade and Repair Unit (URU)



Hardware: 5 minutes

Tools: tool-less

Preliminary steps

- ▶ "Locating the defective server" on page 45.
- ▶ "Checking boot priority" on page 77.
- ▶ "Shutting down the server" on page 47.
- ▶ "Disconnecting the power cord" on page 48.
- ▶ "Getting access to the component" on page 50.

Replacing the Dual microSD 64GB Enterprise

- ▶ Remove the defective Dual microSD 64GB Enterprise, see "[Removing the Dual microSD 64GB Enterprise](#)" on page 343.
- ▶ Remove both microSD cards from the defective Dual microSD 64GB Enterprise.

Proceed as described in the following:

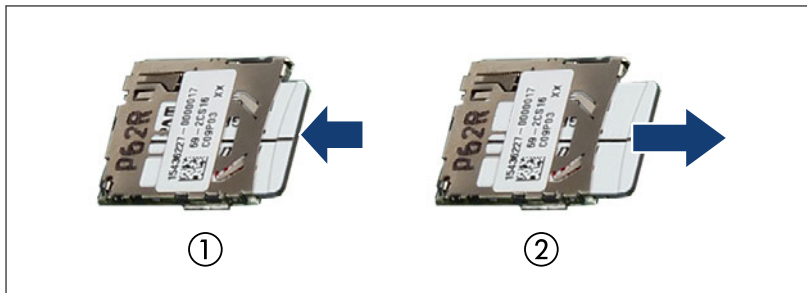

Figure 232: Removing the microSD card

- ▶ To eject the microSD card, gently push it in and then let go (1).
- ▶ Pull the microSD card straight out of its slot (2).

System board and components

- ▶ Install both microSD cards on the new Dual microSD 64GB Enterprise. Proceed as described in the following:

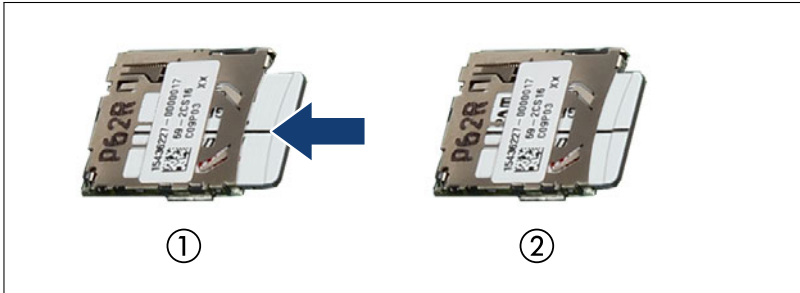



Figure 233: Installing the microSD card

- ▶ With the label facing up, insert the microSD card into the microSD slot on the controller (1) until it locks in place (2).
- ▶ Install the new Dual microSD 64GB Enterprise, see ["Installing the Dual microSD 64GB Enterprise" on page 340](#).

Concluding steps

- ▶ ["Reassembling" on page 56](#).
- ▶ ["Connecting the power cord" on page 59](#).
- ▶ ["Switching on the server" on page 63](#).
- ▶ ["Setting boot priority" on page 100](#).

Software configuration

-  To install the ESXi to the Dual microSD 64GB Enterprise, see ["Software configuration" on page 342](#).

17.7.5 Replacing the microSD card



Upgrade and Repair Unit (URU)



Hardware: 5 minutes

Tools: a pair of side-cutting pliers

Preliminary steps

- ▶ ["Locating the defective server" on page 45.](#)
- ▶ ["Shutting down the server" on page 47.](#)
- ▶ ["Disconnecting the power cord" on page 48.](#)
- ▶ ["Getting access to the component" on page 50.](#)

Replacing the microSD card

- ▶ Remove the Dual microSD 64GB Enterprise, see ["Removing the Dual microSD 64GB Enterprise" on page 343.](#)
- ▶ Remove the defective microSD card from the Dual microSD 64GB Enterprise.

Proceed as described in the following:

- ▶ To eject the defective microSD card, gently push it in and then let go, see [Figure 232.](#)
- ▶ Pull the microSD card straight out of its slot.



CAUTION

(not valid for Europe, Middle East, India and Africa)

The microSD card contains customer information.

- ▶ After removing the microSD card, hand the card over to the customer.
- ▶ If the customer requests disposal of the defective microSD card, proceed as follows: Using a pair of side-cutting pliers, cut the microSD card in half.

System board and components

- ▶ Install the new microSD card on the Dual microSD 64GB Enterprise.
Proceed as described in the following:
 - ▶ With the label facing up, insert the microSD card into the microSD slot on the controller until it locks in place (see [Figure 233](#)).
- ▶ Install the Dual microSD 64GB Enterprise, see "[Installing the Dual microSD 64GB Enterprise](#)" on page 340.

Concluding steps

- ▶ "[Reassembling](#)" on page 56.
- ▶ "[Connecting the power cord](#)" on page 59.
- ▶ "[Switching on the server](#)" on page 63.

17.8 System board

17.8.1 Replacing the system board



Field Replaceable Unit (FRU)



Hardware: 50 minutes

Software: 10 minutes

(Firmware automatic version adjustment: depending on configuration)

Tools: Replacing the system board:

- Phillips PH2 / (+) No. 2 screw driver
- Magnifying glass for inspecting CPU socket springs (recommended)

Replacing the TPM:

- Bit screw driver
- Flat nose pliers
- TPM bit insert (*)
- Thin slotted screw driver (2 x 0.4 mm) (*)

(*) For Japan:

- Dedicated TPM screw driver (CWZ8291A)
- TPM module fixing tool (S26361-F3552-L909)

Note on TPM



The system board can be equipped with an optional TPM (Trusted Platform Module). This module enables third party programs to store key information (e. g. drive encryption using Windows Bitlocker Drive Encryption).

If the customer is using TPM functionality, the TPM has to be removed from the defective system board and connected to the new system board. For a detailed description, see ["Replacing the TPM" on page 321](#).

The TPM has to be enabled in the system BIOS.



CAUTION

- ▶ Before replacing the system board, ask the customer whether TPM functionality is used.
- ▶ If the customer is using TPM functionality, remove the TPM from the old system board and install it on the new system board.
- ▶ Advise your contact persons that they must provide you with all recovery keys which belong to the system to restore them in the TPM later.

Note on network settings recovery



When replacing network controllers or the system board, network configuration settings in the operating system will be lost and replaced by default values. This applies to all static IP address and LAN teaming configurations.

Ensure to note down your current network settings before replacing the system board.

Note on system information backup/restore

The front panel (front panel module, front panel board or front panel on QRL) contains the Chassis ID EPROM that contains system information like server name and model, housing type, serial number and manufacturing data. To avoid the loss of non-default settings when replacing the system board, a backup copy of important system configuration data is automatically stored from the system board NVRAM to the Chassis ID EPROM.



CAUTION

For that reason the front panel and system board must not be replaced simultaneously! In this case, restoring the system configuration data on the system board would fail.

After replacing the system board the backup data is restored from the Chassis ID board to the new system board.

Note on BIOS settings recovery



For replacing the system board, the BIOS has an automatic restore function for the BIOS settings. If the BIOS settings could not be restored after replacing the system board, you must manually change the settings.

Ensure to note down your current BIOS settings before replacing the system board, just in case.



When the system board is replaced, the settings in the **Security** tab on the BIOS setup menu are not automatically transferred, so you must manually restore the BIOS settings.

The settings related to **Security** block all data writing in order to prevent data tampering from external sources such as applications. Restoring BIOS settings is also blocked according to this specification.

Ensure to note down your current BIOS settings before replacing the system board.

Note on BIOS or iRMC automatic version adjustment



When the power cable is connected, iRMC starts and the BIOS/iRMC automatically version is adjusted.

The time to completion is about 25 minutes and depends on the system configuration and iRMC version.

Do not perform the following operations after connecting the power cord. Please wait for the above time to elapse.

- Remove and reinsert the power cord
- Power button on/off
- Connecting and disconnecting other cables, etc.

Note on MicroSD card





The MicroSD card on the system board contains the BIOS/iRMC firmware that is running.

After replacing the system board, the operating version number will be restored based on this information. Do not replace the system board and the MicroSD card at the same time.

Preliminary steps

- ▶ ["Locating the defective server" on page 45.](#)
- ▶ ["Note on network settings recovery" on page 350.](#)
- ▶ ["Suspending BitLocker functionality" on page 73.](#)
- ▶ ["Shutting down the server" on page 47.](#)
- ▶ ["Disconnecting the power cord" on page 48.](#)
- ▶ Disconnect all external cables.
- ▶ ["Getting access to the component" on page 50.](#)
- ▶ Remove the HDD fan module(s), see ["Removing the HDD fan module \(3.5-inch HDD variant\)" on page 67](#) or ["Removing the HDD fan module \(2.5-inch HDD variant\)" on page 70.](#)

- ▶ Remove the following components from the system board:
 - ▶ Heat sink, see ["Removing the standard heat sink" on page 241](#) or ["Removing the performance heat sink" on page 242](#).
 -  Leave the CPU on the defective board for now.
 - ▶ Memory modules, see ["Removing memory modules" on page 236](#).
 -  Ensure to take note of the memory modules' mounting positions for reassembly.
 - ▶ Expansion cards, see ["Removing expansion cards" on page 210](#).
 -  Ensure to take note of the controllers' mounting positions and cable connections for reassembly.
 - ▶ If applicable, iRMC microSD card, see ["Removing the iRMC microSD card" on page 325](#).
 - ▶ If applicable, M.2 SSD, see ["Removing an M.2 SSD" on page 335](#).
 - ▶ If applicable, Dual microSD 64 GB Enterprise, see ["Removing the Dual microSD 64GB Enterprise" on page 343](#).

Removing the defective system board

- ▶ Disconnect all cables from the system board.
- ▶ If applicable, remove all HDD modules, see ["Removing 2.5-inch HDD/SSD modules" on page 156](#).
- ▶ If applicable, remove the HDD cage, see ["Removing the 2.5-inch HDD cage" on page 63](#).
- ▶ If applicable, remove the RDX drive, see ["Removing the RDX drive" on page 271](#).
- ▶ If applicable, remove the power distribution board, see ["Removing the defective power distribution board" on page 123](#).
- ▶ Fold open the slot cover clamp to better reach the two screws in the bottom left corner.

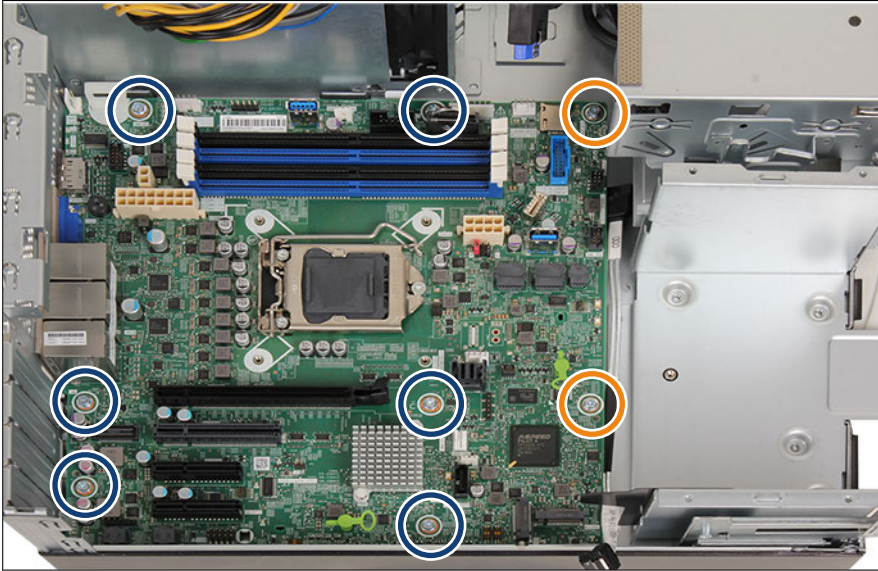

Figure 234: Screws system board

- ▶ Remove the eight screws from the system board (see blue circles, orange circles show the centering bolts).

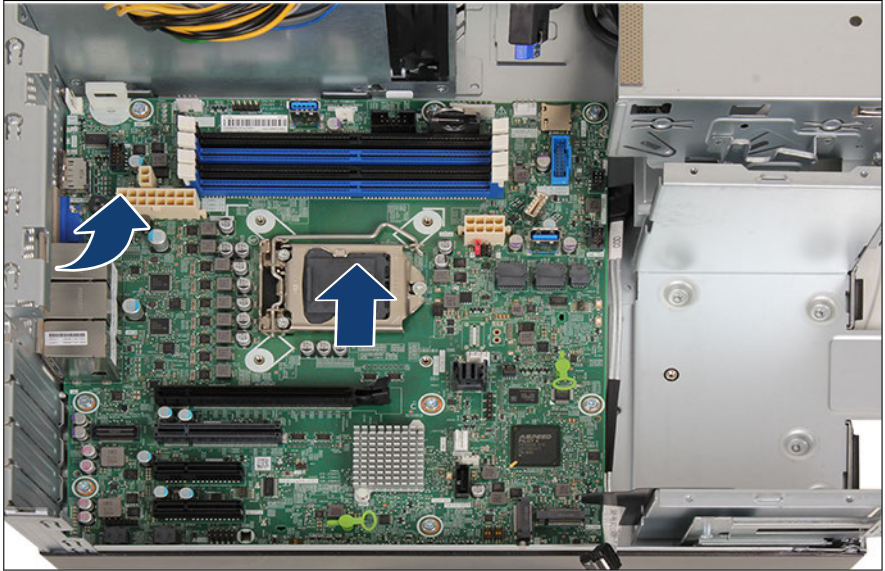

Figure 235: Removing the system board

- ▶ Use both hands to lift the system board carefully out of the chassis in a slight angle. Thereby you pull the connectors out of the I/O panel.



CAUTION

- ▶ Always take the system board with both hands!
 - ▶ **Never lift the system board one-sided or at a heat sink, because the solder connections between the socket and the system board come under tension and increase the risk of damage and malfunction!**
 - ▶ Do not damage the EMI springs which are essential to comply with applicable EMC regulations and satisfy cooling requirements and fire protection measures.
-
- ▶ Place the removed and the new system board on an antistatic surface.
 - ▶ If applicable, remove the TPM, see ["Removing the TPM" on page 316](#).

Installing the new system board

- ▶ If applicable, install the TPM, see ["Installing the TPM" on page 313](#).
- ▶ Check the settings on the new system board, see ["Onboard settings" on page 387](#).
- ▶ Insert the system board by holding it at a slight angle. Slide the connectors into the I/O panel, see [Figure 235](#).
- ▶ Lower the system board carefully into the chassis.
- ▶ Adjust the system board. If necessary adjust the position of the system board with a gentle twisting motion (orange circles in [Figure 234](#) show the centering bolts).
- ▶ Fasten the system board with the eight screws, see [Figure 234](#).
- ▶ Remove the plastic cover from the CPU socket of the new system board.
- ▶ Remove the CPU from the defective system board, see ["Removing the CPU" on page 244](#).
- ▶ Confirm that the CPU model number printed on the top of the CPU fits with the requirements.
- ▶ Install the CPU on the new system board, see ["Installing the CPU" on page 245](#).
- ▶ Fit the protective plastic cover onto the socket of the defective system board which will be sent back to spares.



Returned system boards without this cover probably have to be scrapped.

- ▶ Install the heat sink, see ["Installing the standard heat sink" on page 249](#) or ["Installing the performance heat sink" on page 252](#).
- ▶ If applicable, install the power distribution board, see ["Installing the new power distribution board" on page 127](#).
- ▶ If applicable, install the HDD cage, see ["Installing the 2.5-inch HDD cage" on page 65](#).
- ▶ If applicable, install all HDD modules, see ["Installing 2.5-inch HDD/SSD modules" on page 154](#).

- ▶ If applicable, install the RDX drive, see ["Installing the RDX drive" on page 269](#).

Concluding steps

- ▶ Connect all cables to the system board.



For the cable plan, see ["Appendix B" on page 391](#).

- ▶ Install all remaining system board components as shown in the related sections:

- ▶ If applicable, iRMC microSD card, see ["Installing the iRMC microSD card" on page 323](#).
- ▶ If applicable, M.2 SSD, see ["Installing an M.2 SSD" on page 330](#).
- ▶ If applicable, Dual microSD 64 GB Enterprise, see ["Installing the Dual microSD 64GB Enterprise" on page 340](#).
- ▶ Memory modules, see ["Installing a memory module" on page 234](#).



Ensure that you reinstall each memory module in the slot it was located before the replacement.

- ▶ Expansion cards, see ["Expansion cards and backup units" on page 185](#).



Ensure that you reinstall each card in the slots it was located before the replacement.

- ▶ Install the corresponding HDD fan module(s), see ["Installing the HDD fan module \(2.5-inch HDD variant\)" on page 71](#) or ["Installing the HDD fan module \(3.5-inch HDD variant\)" on page 68](#).
- ▶ ["Reassembling" on page 56](#).
- ▶ Connect all external cables.
- ▶ ["Connecting the power cord" on page 59](#).

System board and components

- ▶ Wait until the firmware automatic version adjustment is completed.



When the power cable is connected, iRMC starts and the BIOS/iRMC automatically version is adjusted.

The time to completion is about 25 minutes and depends on the system configuration and iRMC version.

Do not perform the following operations after connecting the power cord. Please wait for the above time to elapse.

- Remove and reinsert the power cord
 - Power button on/off
 - Connecting and disconnecting other cables, etc.
-
- ▶ Check the status of the power-on indicator to verify if the firmware restore was successful, see ["States of power-on indicator and time duration during firmware automatic version adjustment" on page 377](#).
If the firmware automatic version adjustment is successfully completed, the power-on indicator is lit white.
If the power-on indicator is not lit white, an error has occurred. Disconnect and connect the power cord and try to boot up, or replace the system board again.
 - ▶ After completion of the firmware automatic version adjustment, connect to the iRMC and check the SEL log files, see ["Messages of firmware automatic version adjustment in SEL log files" on page 360](#).
 - ▶ ["Switching on the server" on page 63](#).



When the system is powered on after a CPU has been replaced or upgraded, the Global Error indicator will start flashing with the message CPU has been changed.

This only indicates that the CPU configuration has been altered. There is no technical problem.

Proceed as follows:

- Restart your server.
 - As soon as the startup screen appears, press the [F2] function key to enter the BIOS.
 - If a password is assigned, enter the password and press [Enter].
 - Select the **Save & Exit** menu.
 - Select **Save Changes and Exit** or **Save Changes and Reset**.
 - Verify that the Global Error indicator stops flashing.
- ▶ ["Verifying the system time settings" on page 86.](#)
 - ▶ If applicable, activate TPM functionality in the system BIOS under **Security > TPM (Security Chip) Setting > Security Chip**. For more information, see the corresponding BIOS Setup Utility reference manual.
 - ▶ ["Verifying system information backup or restore" on page 80.](#)
 - ▶ ["Looking for MAC/WWN/GUID and SAS addresses" on page 92.](#)
 - ▶ ["Updating the NIC configuration file in a Linux and VMware environment" on page 89.](#)
 - ▶ ["Resuming BitLocker functionality" on page 90.](#)
 - ▶ If applicable, reconfigure your network settings in the operation system according to the original configuration of the replaced controller (expansion card or onboard).
-
- Configuration of network settings should be performed by the customer. For more information, see ["Note on network settings recovery" on page 350.](#)
- ▶ If applicable, restore LAN teaming configurations, see ["5.3.15 Configuring LAN teaming"](#).

Messages of firmware automatic version adjustment in SEL log files

If the firmware automatic version adjustment is successful, the following messages will be recorded.

- When firmware version in iRMC microSD card and firmware version of replaced system board are different:

```
...
<iRMC>: Firmware 1 has been successfully restored from SD
card.
<iRMC>: Firmware 2 has been successfully restored from SD
card.
...
Chassis IDPROM: BIOS restore successful
...
BIOS TFTP or HTTP/HTTPS flash OK.
```

- When firmware version in iRMC microSD card and firmware version of replaced system board are same:

```
...
Restore of iRMC firmware 1 omitted because the already
flashed firmware has the same version
Restore of iRMC firmware 2 omitted because the already
flashed firmware has the same version
...
Chassis IDPROM: BIOS restore successful
...
BIOS TFTP or HTTP/HTTPS flash OK.
```

18 Appendix A

18.1 Mechanical overview

18.1.1 Server front

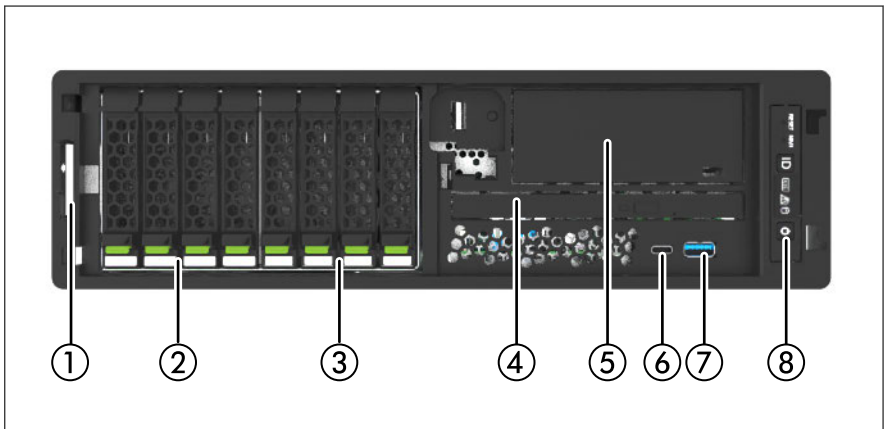

Figure 236: Front side 2.5-inch HDD variant

- | | | | |
|---|---------------------------------------|---|--------------------------------|
| 1 | ID card slot | 5 | RDX drive |
| 2 | 2.5-inch HDDs/SSDs SAS/SATA/PCIe (4x) | 6 | USB 3.2 Gen 2 Type C connector |
| 3 | 2.5-inch HDDs/SSDs SAS/SATA (4x) | 7 | USB 3.2 Gen 1 Type A connector |
| 4 | ODD | 8 | Front panel module |

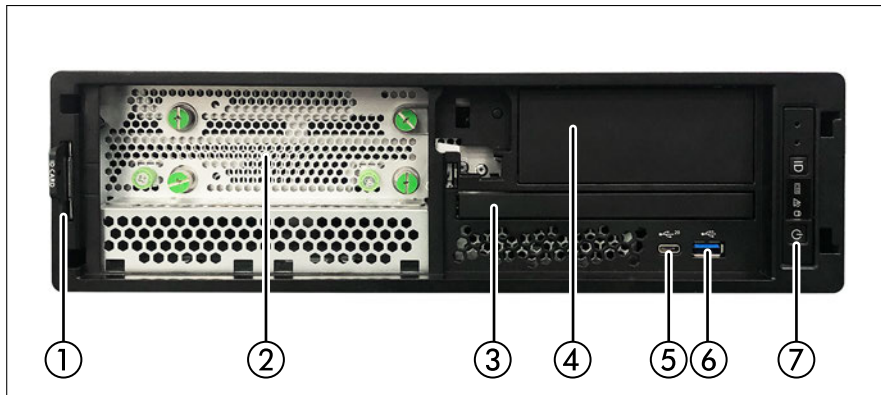

Figure 237: Front side 3.5-inch HDD variant

- | | | | |
|---|-------------------------|---|--------------------------------|
| 1 | ID card slot | 5 | USB 3.2 Gen 2 Type C connector |
| 2 | 3.5-inch HDDs SATA (2x) | 6 | USB 3.2 Gen 1 Type A connector |
| 3 | ODD | 7 | Front panel module |
| 4 | RDX drive | | |

18.1.2 Server rear

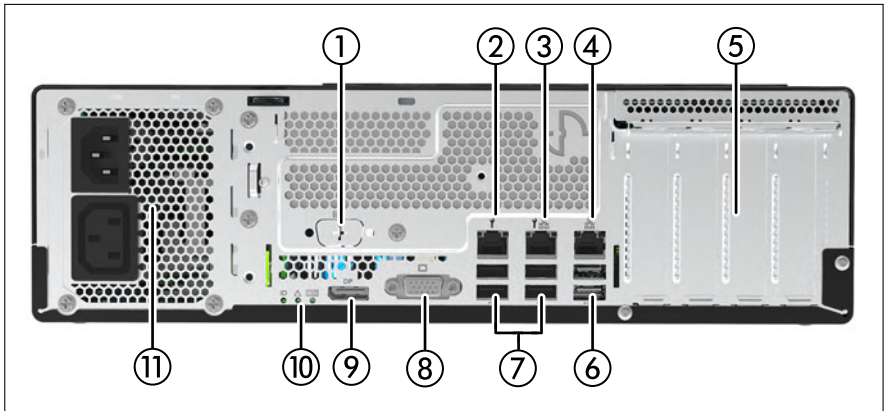

Figure 238: Rear side with standard power supply

- | | | | |
|---|-------------------------------|----|------------------------------------|
| 1 | Serial connector | 7 | USB connectors 2.0 (4x) |
| 2 | Management LAN connector | 8 | VGA connector |
| 3 | Shared LAN connector (LAN1) | 9 | Display Port |
| 4 | Standard LAN connector (LAN2) | 10 | CSS / Global Error / ID indicators |
| 5 | Optional expansion cards (4x) | 11 | Standard PSU |
| 6 | USB 3.2 Gen 2 connectors (2x) | | |

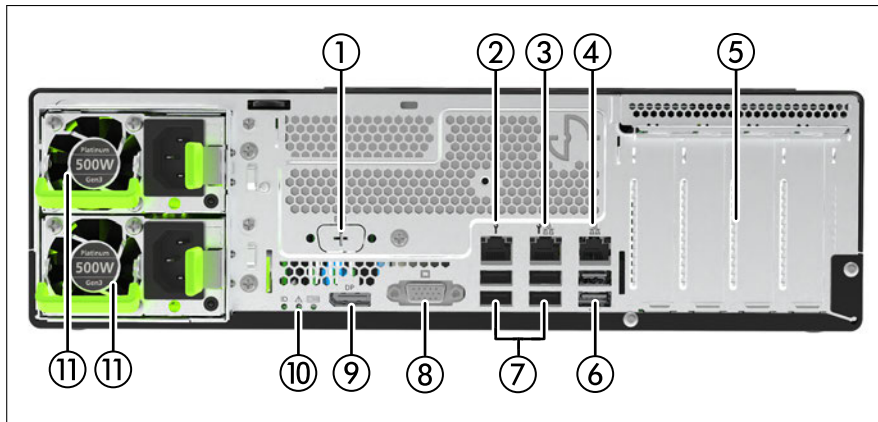

Figure 239: Rear side with redundant power supply

- | | | | |
|---|-------------------------------|----|------------------------------------|
| 1 | Serial connector | 7 | USB connectors 2.0 (4x) |
| 2 | Management LAN connector | 8 | VGA connector |
| 3 | Shared LAN connector (LAN1) | 9 | Display Port |
| 4 | Standard LAN connector (LAN2) | 10 | CSS / Global Error / ID indicators |
| 5 | Optional expansion cards (4x) | 11 | Up to two PSUs / dummy cover |
| 6 | USB 3.2 Gen 2 connectors (2x) | | |

18.1.3 Server interior

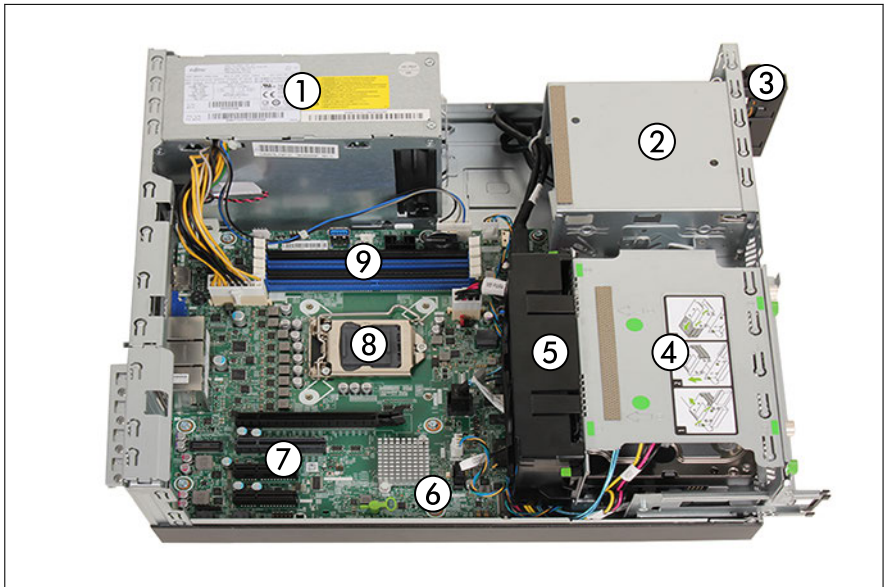

Figure 240: Interior (3.5-inch HDD variant with standard power supply)

- | | | | |
|---|----------------------|---|--------------------|
| 1 | Standard PSU | 6 | System board D3931 |
| 2 | Accessible drive bay | 7 | PCIe slots |
| 3 | Front panel module | 8 | CPU / heat sink |
| 4 | HDD bays | 9 | Memory modules |
| 5 | HDD fan module | | |

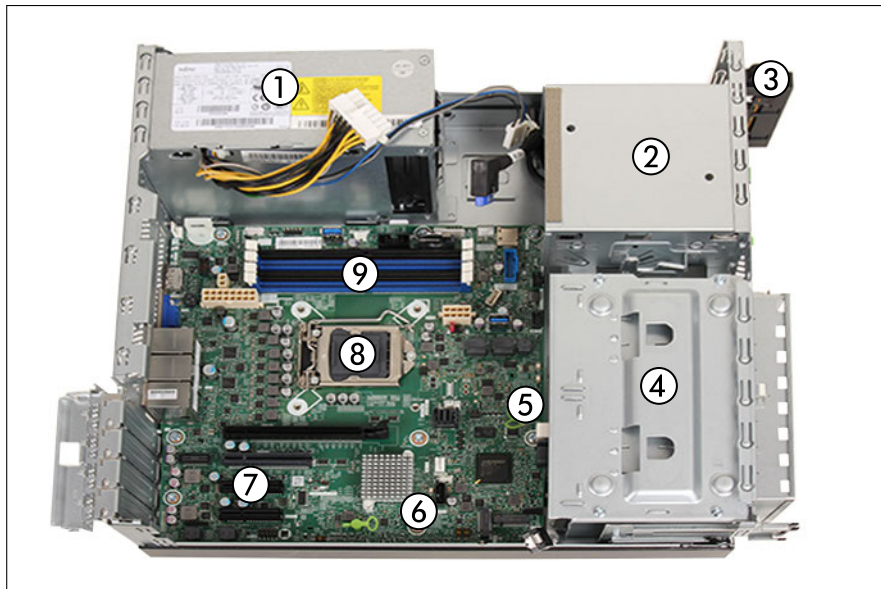

Figure 241: Interior (2.5-inch HDD variant with standard power supply)

- | | | | |
|---|----------------------|---|--------------------|
| 1 | Standard PSU | 6 | System board D3931 |
| 2 | Accessible drive bay | 7 | PCIe slots |
| 3 | Front panel module | 8 | CPU / heat sink |
| 4 | HDD bays | 9 | Memory modules |
| 5 | HDD fan modules | | |

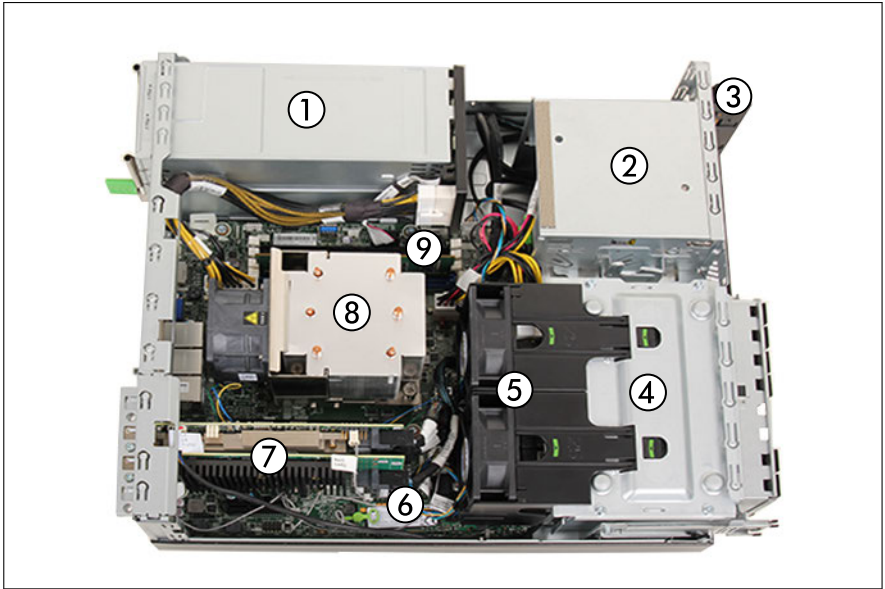

Figure 242: Interior (2.5-inch HDD variant with redundant power supply)

- | | | | |
|---|--------------------------------|---|--------------------|
| 1 | Hot-plug PSUs/ PSU dummy cover | 6 | System board D3931 |
| 2 | Accessible drive bay | 7 | PCIe slots |
| 3 | Front panel module | 8 | CPU / heat sink |
| 4 | HDD bays | 9 | Memory modules |
| 5 | HDD fan modules | | |

18.2 Connectors and indicators

18.2.1 Connectors and indicators on the system board

18.2.1.1 Connectors and indicators on the system board

Onboard connectors

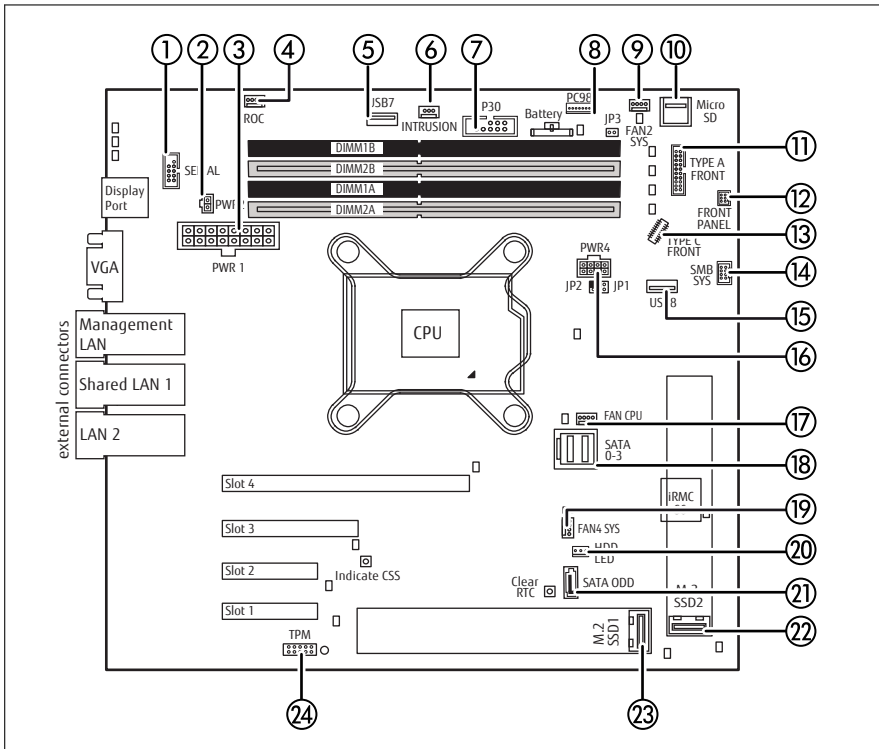

Figure 243: Internal connectors of system board D3931

No.	Print	Description
1	SERIAL	Connector for rear wall
2	PWR2	PSU connector

No.	Print	Description
3	PWR1	PSU connector
4	ROC	Connector for Dual microSD 64GB Enterprise cable
5	USB7	Connector for Dual microSD 64GB Enterprise
6	INTRUSION	Connector for intrusion cable
7	P30	PSU connector
8	PC98	Data cable connector for standard PSU
9	FAN2 SYS	Connector for FAN2 inside
10	Micro SD	iRMC microSD card
11	TYPE A FRONT	Connector for front USB cable
12	FRONT PANEL	Front panel connector
13	TYPE C FRONT	Connector for front USB cable
14	SMB SYS	OOB (Out-Of-Band) connector for HDD backplanes
15	USB8	Connector for RDX USB cable
16	PWR4	Connector for HDD backplane/ODD power cable
17	FAN CPU	Connector for CPU FAN
18	SATA 0-3	SATA HDD connector
19	FAN4 SYS	Connector for FAN1 inside
20	HDD LED	Connector for HDD LED cable (e.g. PRAID EP5x0i)
21	SATA ODD	Connector for SATA ODD
22	M.2 SSD2	M.2 slot 2
23	M.2 SSD1	M.2 slot 1
24	TPM	Connector for optional TPM

Onboard indicators and controls

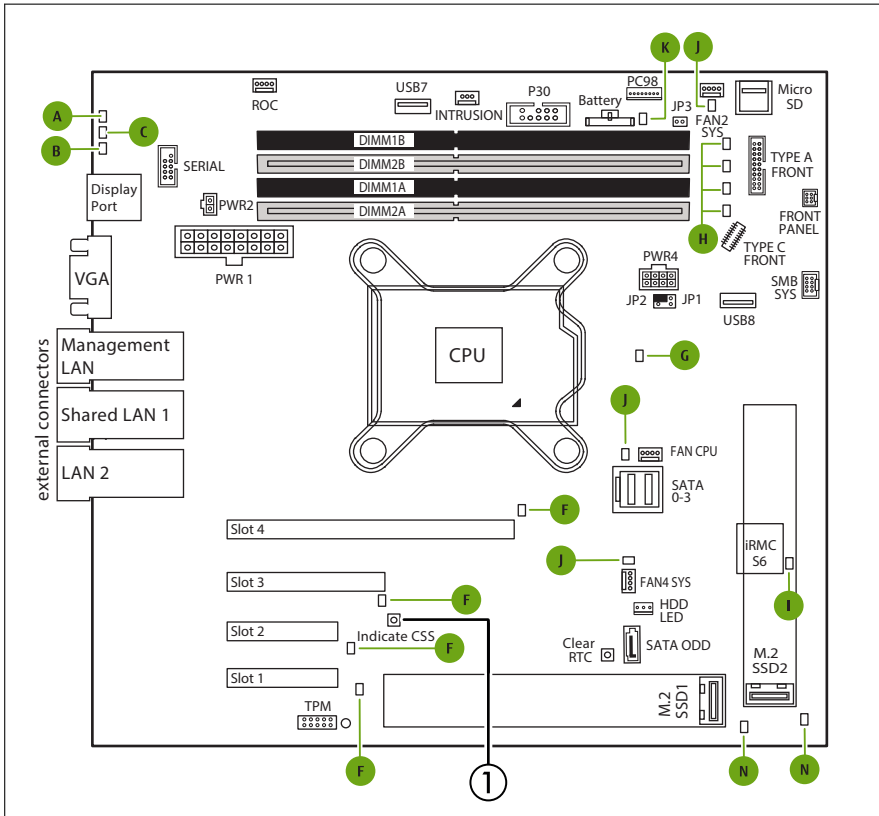

Figure 244: Onboard indicators and Indicate CSS button

1 Indicate CSS button

i LEDs A, B and C are visible from outside on the server rear. All other LEDs are only visible if the server cover has been opened.

If the server has been powered off (power plugs must be disconnected) it is possible to indicate the faulty component by pressing the indicate CSS button. The LEDs have the following meaning:

A - Identification

Status	Description
blue on	The server has been highlighted using iRMC web interface or the ID button on the front panel for easy identification.
flashing blue	The server has been highlighted for easy identification using the iRMC (AVR) with disabled local VGA output.

B - CSS (Customer Self Service)

Status	Description
off	No critical event detected (CSS component).
orange on	Prefailure event detected (CSS component).
flashing orange	CSS component failure detected.

C - GEL (Global Error LED)

Status	Description
off	No critical event detected (non-CSS component).
orange on	Prefailure event detected (non-CSS component).
flashing orange	Non-CSS component failure detected. Possible causes: <ul style="list-style-type: none"> – System is out of the specified temperature range – Defective sensor – CPU error – Error detected by server management software

Appendix A

F - Controller

Status	Description
off	Controller okay
orange on	Controller failure

G - CPU

Status	Description
off	CPU okay
orange on	CPU failure

H - Memory

Status	Description
off	memory module running
orange on	memory module failure

I - iRMC

Status	Description
off	iRMC S6 inactive
flashing green	iRMC S6 okay

J - System fan

Status	Description
off	system fan running
orange on	system fan failure

K - Battery

Status	Description
orange on	Battery faulty

N - M.2 SSD

Status	Description
orange on	M.2 SSD faulty

18.2.2 Server front

18.2.2.1 Connectors on the server front

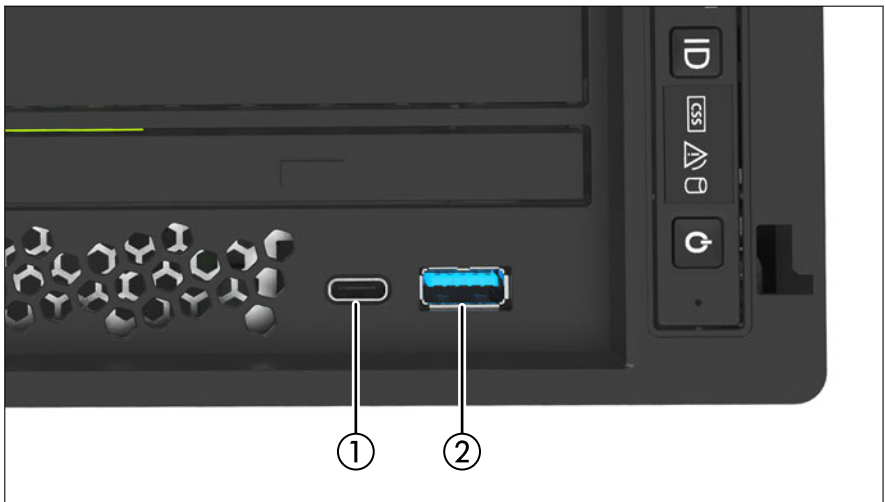

Figure 245: Connectors on the server front

- 1 USB 3.2 Gen 2 Type C connector 2 USB 3.2 Gen 1 Type A connector

18.2.2.2 Indicators on the front panel

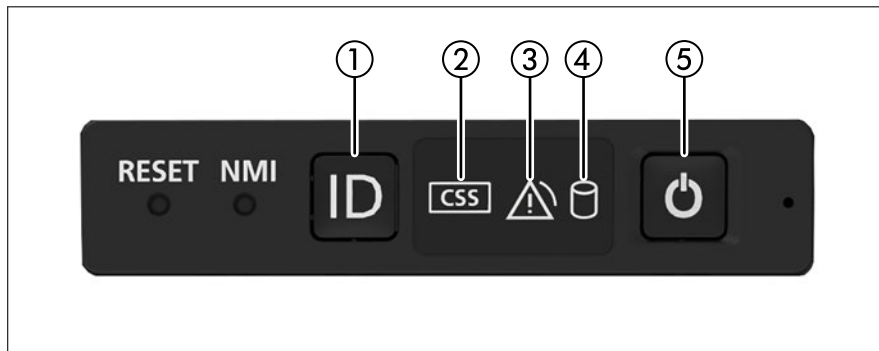

Figure 246: Indicators on the front panel

- 1 ID indicator
- 2 CSS indicator
- 3 Global Error indicator
- 4 HDD/SSD activity indicator
- 5 Power-on/AC connected indicator

ID indicator (1)

See also ["iRMC-related status signals" on page 376](#).

Status	Description
blue on	The server has been highlighted using the iRMC web interface or the ID button on the front panel for easy identification.
flashing blue	The server has been highlighted for easy identification using the iRMC with disabled local VGA output.

CSS indicator (2)

Status	Description
off	No critical event detected (CSS component).
orange on	Prefailure event detected (CSS component). For HDDs, see also "HDD prefailure detection" on page 376 .
flashing orange	CSS component failure detected.

Global Error indicator (3)

See also ["iRMC-related status signals" on page 376](#).

Status	Description
off	No critical event detected (non-CSS component).
orange on	Prefailure event detected (non-CSS component).
flashing orange	Non-CSS component failure detected. Possible causes: <ul style="list-style-type: none"> – System is out of the specified temperature range – Defective sensor – CPU error – Error detected by server management software

HDD/SSD activity indicator (4)

Status	Description
flashing green	Data access in progress.

Power-on/AC connected indicator (5)

Status	Description
off	The server is switched off.
green on	The server is switched on and operating normally.
flashing white	The BMC firmware is starting up after the server has been connected to the mains.
white on	Server is switched off and connected to the mains (standby mode).
flashing green & white	Server has been switched on but Power Cycle Delay settings delay it.

iRMC-related status signals

ID indicator	Global error indicator	Description
flashing blue	off	A remote connection has been established. Local VGA output has been disabled during the remote session.
flashing blue	flashing orange	An emergency flash of the iRMC firmware is in progress.



For more information about the iRMC flash procedure, see "Basic software procedures" in the "FUJITSU Server PRIMERGY TX1320 M5 Upgrade and Maintenance Manual".

HDD prefailure detection

Depending on your hardware configuration HDD prefailure detection will be supported.

The requirements are:

- iRMC S6 Firmware
- supported OOB RAID system

18.2.2.3 States of power-on indicator and time duration during firmware automatic version adjustment

The power-on indicator changes as follows from the time the power cord is connected to the time the automatic version adjustment is completed.

	System state	Power-on indicator	Time
a	Power cord connected (AC on)	-	-
b	During startup of iRMC	off	About 1 minutes
c	iRMC startup complete	several times, white blink	Several seconds
d	Matching iRMC FW version x2	white flashing	About 7 minutes
e	iRMC startup complete	white on	About 1 minute
f	Server Auto (DC) On Initial BIOS Settings	green on	About 3 minutes
g	Server Reboot	white on	Several seconds
h	Matching BIOS version Restart several times.	green on	About 12 minutes depending on system configuration
i	Matching completed, (DC) OFF	white on	-

Section E and later allow iRMC to connect to the WebUI.

In section g and later, the screen will be displayed on the connected display. Check the screen.

18.2.2.4 Indicator on the ODD



ODDs may have an indicator or not.

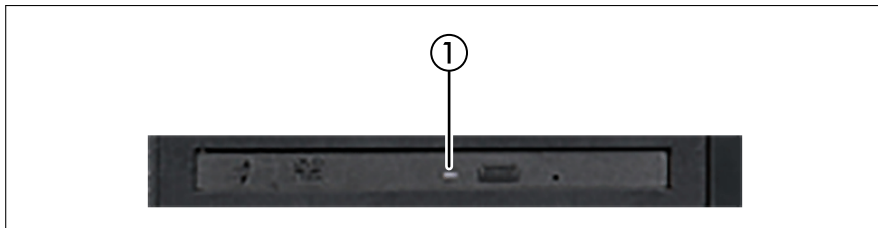

Figure 247: Indicator on the ODD (example)

- 1 Activity indicator

Activity indicator (1)

Status	Description
off	The ODD is inactive.
green on	The storage medium is being accessed.

18.2.2.5 Indicators on the RDX drive



Figure 248: Indicators on the RDX drive

- 1 RDX drive Power-on indicator

RDX drive Power-on indicator (1)

Status	Description
off	The drive is not powered on.
green on	The drive is ready and working properly.
green flashing	The drive is ejecting media.
amber on	RDX has detected a drive failure condition. For more information, run a diagnostics application.
green on / amber flashing once eject button is pressed	Host computer is accessing the media and the user has pressed the eject button. The drive will eject the media after host access is complete.

18.2.2.6 Indicators on hot-plug HDD / SSD / PCIe SSD modules

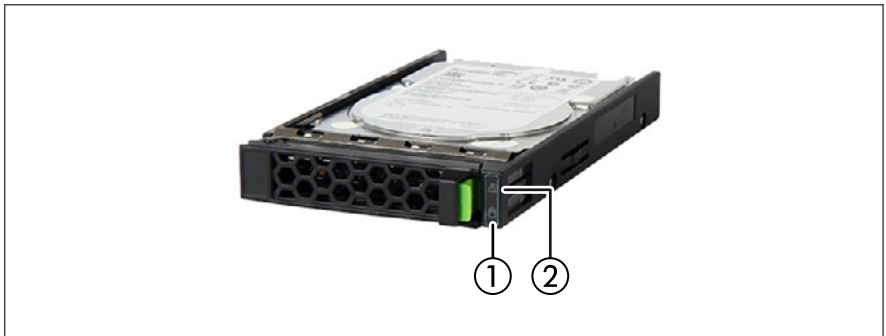

Figure 249: Indicators on an HDD / SSD / PCIe SSD module

1 Access indicator

2 Error indicator

Access indicator (1)

Status	Description
off	The HDD/SSD is inactive.
green on	The HDD/SSD being accessed.

Error indicator (2)

Status	Description
off	No HDD/SSD error detected.
orange on	An HDD/SSD error has been detected. Possible causes: <ul style="list-style-type: none">– The drive is defective and needs replacing.– A RAID rebuild process has failed.– The HDD/SSD module has not been inserted correctly.
flashing orange slowly	HDD/SSD RAID rebuild is in progress. Data is being restored after replacing a drive that has been combined into a RAID array.

18.2.3 Server rear

18.2.3.1 Connectors on the server rear

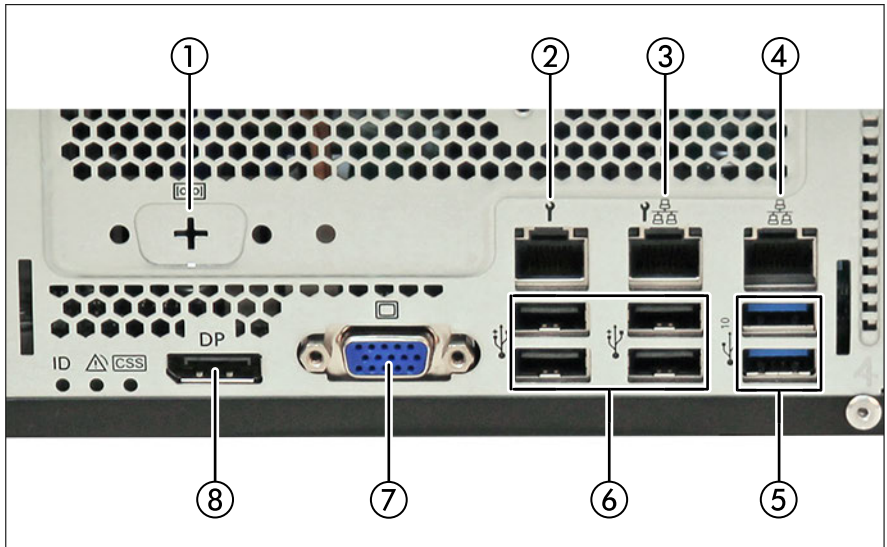

Figure 250: Connectors on the I/O panel

- | | | | |
|---|-------------------------------|---|-------------------------------|
| 1 | Serial interface COM1 * | 5 | USB 3.2 Gen 2 connectors (2x) |
| 2 | Management LAN connector | 6 | USB 2.0 connectors (4x) |
| 3 | Shared LAN connector (LAN1) | 7 | VGA connector |
| 4 | Standard LAN connector (LAN2) | 8 | Display Port |

* The serial interface can be used as the standard interface or for communication with iRMC.

i Depending on the BIOS settings, the shared LAN connector may also be used as a management LAN connector. For more information, see the corresponding BIOS Setup Utility reference manual.

i Some of the devices connected require special software (e.g. drivers) (see documentation for the connected device).

18.2.3.2 ID, CSS and Global Error indicators

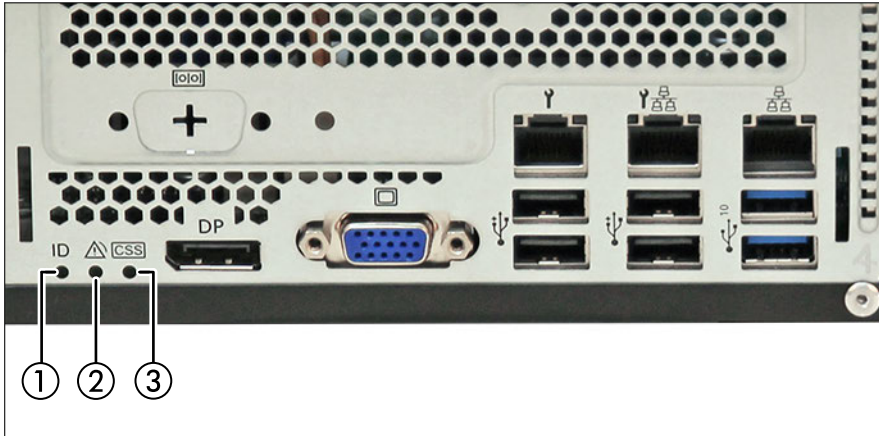

Figure 251: ID, CSS and Global Error indicators

- 1 ID indicator
- 2 Global Error indicator
- 3 CSS indicator

i If CSS and Global Error indicators are located in the same place on the I/O panel of the server, also check the indicators on the front panel to determine if a CSS or Global Error event has been detected.

i For more information on detected errors, see the System Event Log or iRMC web interface.

ID indicator (1)

See also "[iRMC-related status signals](#)" on page 383.

Status	Description
blue on	The server has been highlighted using iRMC web interface or the ID button on the front panel for easy identification.
flashing blue	The server has been highlighted for easy identification using the iRMC (AVR) with disabled local VGA output.

Global Error indicator (1)

See also ["iRMC-related status signals" on page 383](#).

Status	Description
off	No critical event detected (non-CSS component).
orange on	Prefailure event detected (non-CSS component).
flashing orange	Non-CSS component failure detected. Possible causes: <ul style="list-style-type: none"> – System is out of the specified temperature range – Defective sensor – CPU error – Error detected by server management software

CSS indicator (1)

Status	Description
off	No critical event detected (CSS component).
orange on	Prefailure event detected (CSS component).
flashing orange	CSS component failure detected.

iRMC-related status signals

ID indicator	Global error indicator	Description
flashing blue	off	A remote connection has been established. Local VGA output has been disabled during the remote session.
flashing blue	flashing orange	An emergency flash of the iRMC firmware is in progress.

i For more information about the iRMC flash procedure, see "Basic software procedures" in the "FUJITSU Server PRIMERGY TX1320 M5 Upgrade and Maintenance Manual".

18.2.3.3 LAN indicators

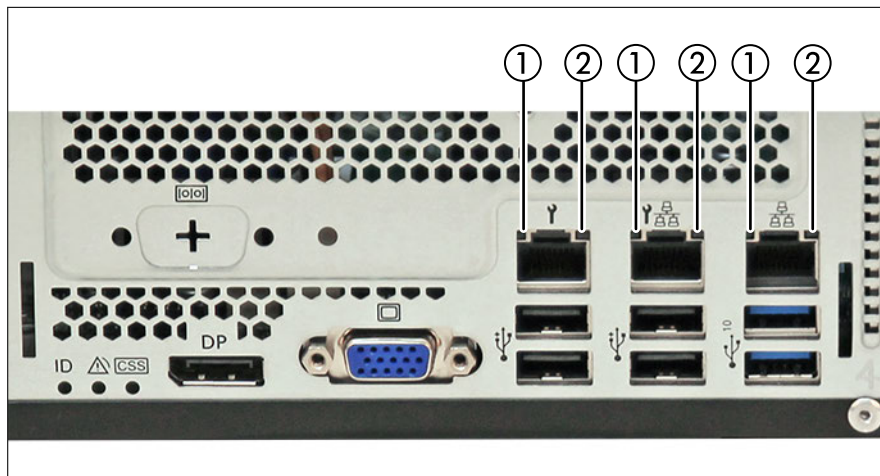

Figure 252: LAN indicators

- 1 LAN link/transfer indicator
- 2 LAN speed indicator

LAN link/transfer indicator (1)

Status	Description
green on	LAN connection has been established.
off	LAN is not connected.
flashing green	LAN data transfer is in progress.

LAN speed indicator (2)

Status	Description
yellow on	Data traffic at a transfer rate of 1 Gbit/s.
green on	Data traffic at a transfer rate of 100 Mbit/s.
off	Data traffic at a transfer rate of 10 Mbit/s.

18.2.3.4 Indicator on hot-plug PSU



Figure 253: Indicator on hot-plug PSU

1 PSU status indicator

PSU status indicator (1)

Status	Description
flashing green	The server is switched off, but mains voltage is present (standby mode).
green on	The server is switched on and operating properly.
flashing orange	An overload has been detected. The PSU is still running, but failure might be imminent.
orange on	A PSU failure has been detected.

18.3 Acoustic indicators

PEI Beep Codes

Pre-EFI Initialization (PEI) - memory Initialization (bootblock)

# of Beep	Description	Action
1	Memory not installed	<ul style="list-style-type: none"> ▶ Check if the memory module is installed. ▶ Check if the memory module is installed correctly.

DXE Beep Codes

Driver Execution Environment (DXE) - main hardware Initialization (POST)

# of Beep	Description	Action
1	Invalid password	<ul style="list-style-type: none"> ▶ Check for the correct password and try again. Make sure that the caps lock key is deactivated.
6	BIOS flash update is failed	<p>A processing bar and an error message is displayed on the screen.</p> <p>This beep code is only an information.</p>

18.4 Onboard settings

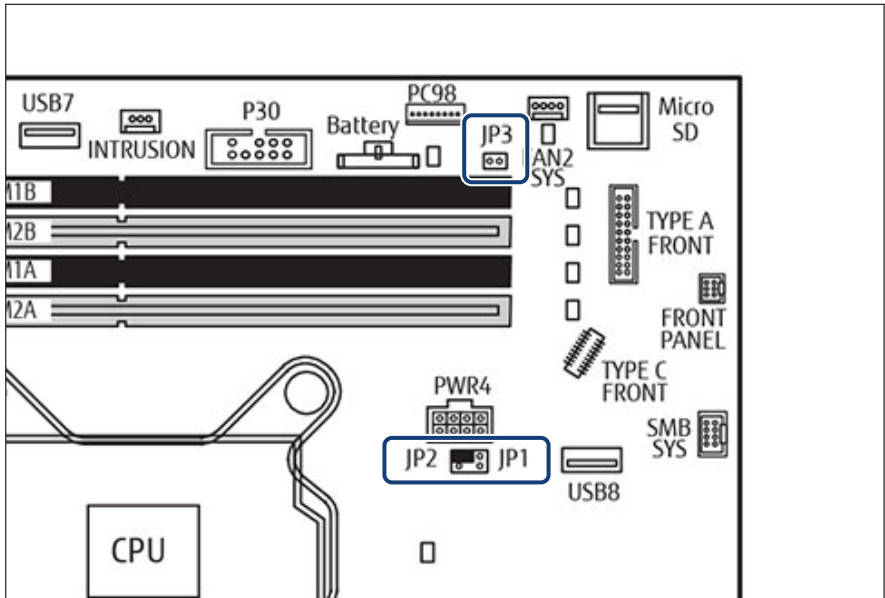

Figure 254: Onboard settings on system board D3931

Jumper		Status	Description
JP1/JP2			Default (place to keep the jumper)
	Password Clear (JP1)		Password Clear enabled
	Recovery BIOS (JP2)		Recovery BIOS enabled
JP3	BIOS WP		Default
			BIOS Flash Write Protect enabled

18.5 Minimum startup configuration



Field Replaceable Units (FRU)

If the server does not start up or other problems occur, it may be necessary to take the system down to its most basic configuration in order to isolate the defective component.

The minimum startup configuration consists of the following components and cables:

Component	Notes and reference
System board	no TPM, expansion cards, or M.2 SSD installed
1 CPU with CPU heat sink	no fan (disconnect fan cable)
1 memory module	installed in DIMM slot 1A
Front panel module	
1 PSU	Standard PSU or hot-plug PSU installed in bay PSU 1

Table 5: Minimum startup configuration - components

Cable	Notes and reference
Front panel cable	
Power cable	

Table 6: Minimum startup configuration - cables

- ▶ ["Shutting down the server" on page 47.](#)
- ▶ ["Disconnecting the power cord" on page 48.](#)
- ▶ Take the system down to its minimum startup configuration.
- ▶ ["Connecting the power cord" on page 59.](#)
- ▶ Connect a display to the server.
- ▶ ["Switching on the server" on page 63.](#)



CAUTION

- ▶ Since the fan module is not included in the minimum startup configuration, the server must be shut down immediately after the diagnostic process is complete (POST phase has been passed).
- ▶ The minimum startup configuration must be used exclusively for diagnostic purposes by maintenance personnel, never in daily operation!

19 Appendix B

19.1 Supplied documents

The following documents are available in this appendix:

- "Cable plan for FUJITSU Server PRIMERGY TX1320 M5 Reference Manual"
- "List of Released Adapters incl. Installation sequence and priority"
- "List of screws used in PRIMERGY Servers - Assembled in Czech and Japan"
- "List of all used screws for TX1320 M5"

Cable Plan for FUJITSU Server PRIMERGY TX1320 M5

Reference Manual

Contents

List of used cables	3
List of used cables(Cont.)	4
SYS Board Connector D3931	5
BasicCabling	6
BasicCablingStdPSU	7
BasicCablingRedPSU	8
PowerCabling3.5HDD	9
PowerCabling2.5HDD	10
PowerCabling2.5HDD with NVMe	11
OOBCabling2.5HDD	12
OOBCabling2.5HDD with NVMe	13
AccDrv_ODD_RDX	14
Data FBU	15
Data HDD Activity	16
Data 3.5_2xSATA_OnBoard	17
Data 3.5_2xSATA_MiniSAS HD HBA/RAID	18
Data 3.5_2xSATA_SlimSAS HBA/RAID	19
Data 2.5_4xSATA_OnBoard	20
Data 2.5_4xSAS/SATA_MiniSAS HD HBA/RAID	21
Data 2.5_4xSAS/SATA_SlimSAS HBA/RAID	22
Data 2.5_8xSAS/SATA_MiniSAS HD HBA/RAID	23
Data 2.5_8xSAS/SATA_SlimSAS HBA/RAID	24
Data 2.5_4xNVMe_4xSAS/SATA_EP5x0i	25
Data 2.5_4xNVMe_4xSAS/SATA_EP6x0i/3258-16i	26
System FANs	27
Serial Port	28

List of used cables

Ref.	FUJITSU PN	Naming	Part of
Basic			
C1	CA05973-7028	ODD SIGNAL CABLE	SKD all> AccDrv_ODD_RDX
C2	CA05973-7039	FRONT IO USB CABLE	SKD all> BasicCabling
C3	CA05973-7032	2.5" HDD BP OOB CABLE	SKD-2.5" Red./2.5" Std.> OOBCabling2.5HDD OOBCabling2.5HDD with NVMe
C4	CA05973-7034	PDB SIDEBAND CABLE	SKD- 2.5" Red.> BasicCablingRedPSU
Power			
C5	CA05973-7029	ODD/3.5" SATA PWR CABLE	SKD- 3.5" Std.> PowerCabling3.5HDD
C6	CA05973-7030	ODD/2.5" PWR CABLE	SKD-2.5" Red./2.5" Std.> PowerCabling2.5HDD PowerCabling2.5HDD with NVMe
C7	CA05973-7033	PDB PWR CABLE	SKD- 2.5" Red.> BasicCablingRedPSU
Data			
C8	CA05973-7035	RDX USB CABLE	Opt.> AccDrv_ODD_RDX
C9	CA05973-7063	TX M5 HDD LED CABLE, 1 to 1, 250mm	Opt.> Data HDD Activity
C10	CA05973-7064	TX M5 HDD LED CABLE, 1 to 2, 250mm	Opt.> Data HDD Activity Data 2.5_4xNVMe_4xSAS/SATA_EP5x0i Data 2.5_4xNVMe_4xSAS/SATA_EP6x0i/3258-16i
C11	CA05973-8012	TX M5 HDD LED CABLE, 1 to 1, 150mm	Opt.> Data HDD Activity
C12	CA05973-7031	3.5 SATA SIGNAL CABLE	SKD> Data 3.5_2xSATA_OnBoard Data 3.5_2xSATA_MiniSAS HD HBA/RAID
C13	CA05973-7036	OB-SATA/RAID SAS SIGNAL CABLE	Opt.> Data 2.5_4xSATA_OnBoard Data 2.5_4xSAS/SATA_MiniSAS HD HBA/RAID Data 2.5_8xSAS/SATA_MiniSAS HD HBA/RAID Data 2.5_4xNVMe_4xSAS/SATA_EP5x0i
C14	CA05973-7065	TX M5 RS-232 CABLE	Opt.> Serial Port
C15	CA05973-7043	TX1320 EP5 2P/NVME CABLE	Opt> Data 2.5_4xNVMe_4xSAS/SATA_EP5x0i
C16	T26139-Y4031-V107	Broadcom FBU CABLE	Opt.> Data FBU
C17	T26139-Y4018-V8	DUAL MICRO SD CARD ROC CABLE	Opt.> Dual_Micro_SD_64GB_Enterprise

List of used cables(Cont.)

Ref.	FUJITSU PN	Naming	Part of
Data			
C18	CA05973-7920	TX1320 EP6 2P/NVME CABLE	Opt.> Data 2.5_4xNVMe_4xSAS/SATA_EP6x0i/3258-16i
C19	CA05973-7921	4 HDD SAS SIGNAL CABLE for C6/L6 RAID	Opt.> Data 2.5_4xSAS/SATA_SlimSAS HBA/RAID Data 2.5_4xNVMe_4xSAS/SATA_EP6x0i/3258-16i
C20	CA05973-7922	8 HDD SAS SIGNAL CABLE for C6/L6 RAID	Opt.> Data 2.5_8xSAS/SATA_SlimSAS HBA/RAID
C21	CA05973-7923	3.5 SATA SIGNAL CABLE for C6/L6 RAID	Opt.> Data 3.5_2xSATA_SlimSAS HBA/RAID
C22	CA05973-7087	TX M5 HDD LED CABLE, 1 to 1, 250mm	Opt.> Data HDD Activity
C23	CA05973-7088	TX M5 HDD LED CABLE, 1 to 2, 250mm	Opt.> Data HDD Activity Data 2.5_4xNVMe_4xSAS/SATA_EP6x0i/3258-16i
C24	CA05973-8919	Microchip FBU CABLE	Opt.> Data FBU

SYS Board Connector D3931

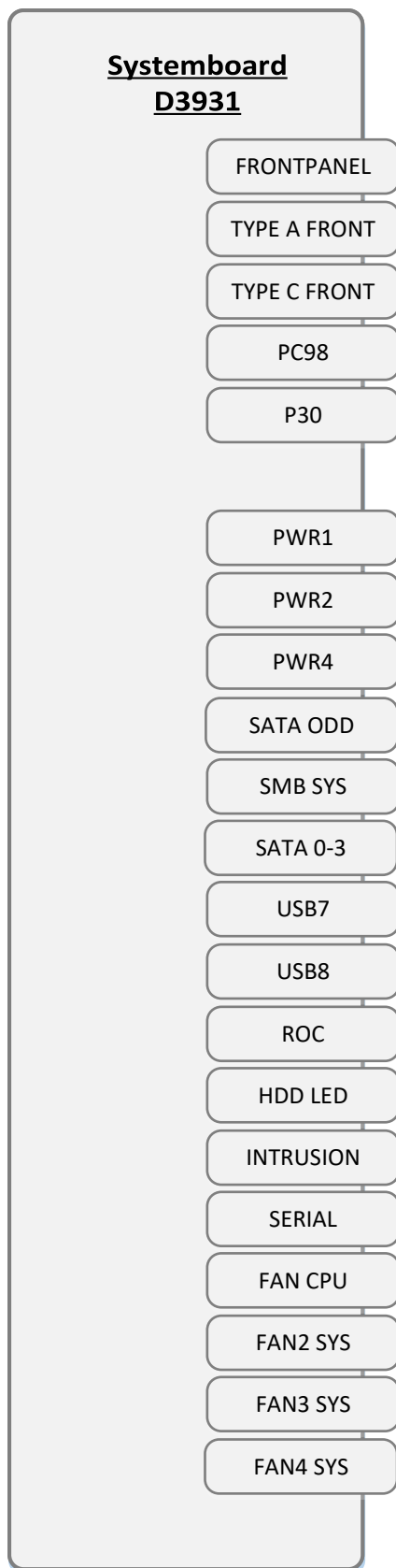

BasicCabling

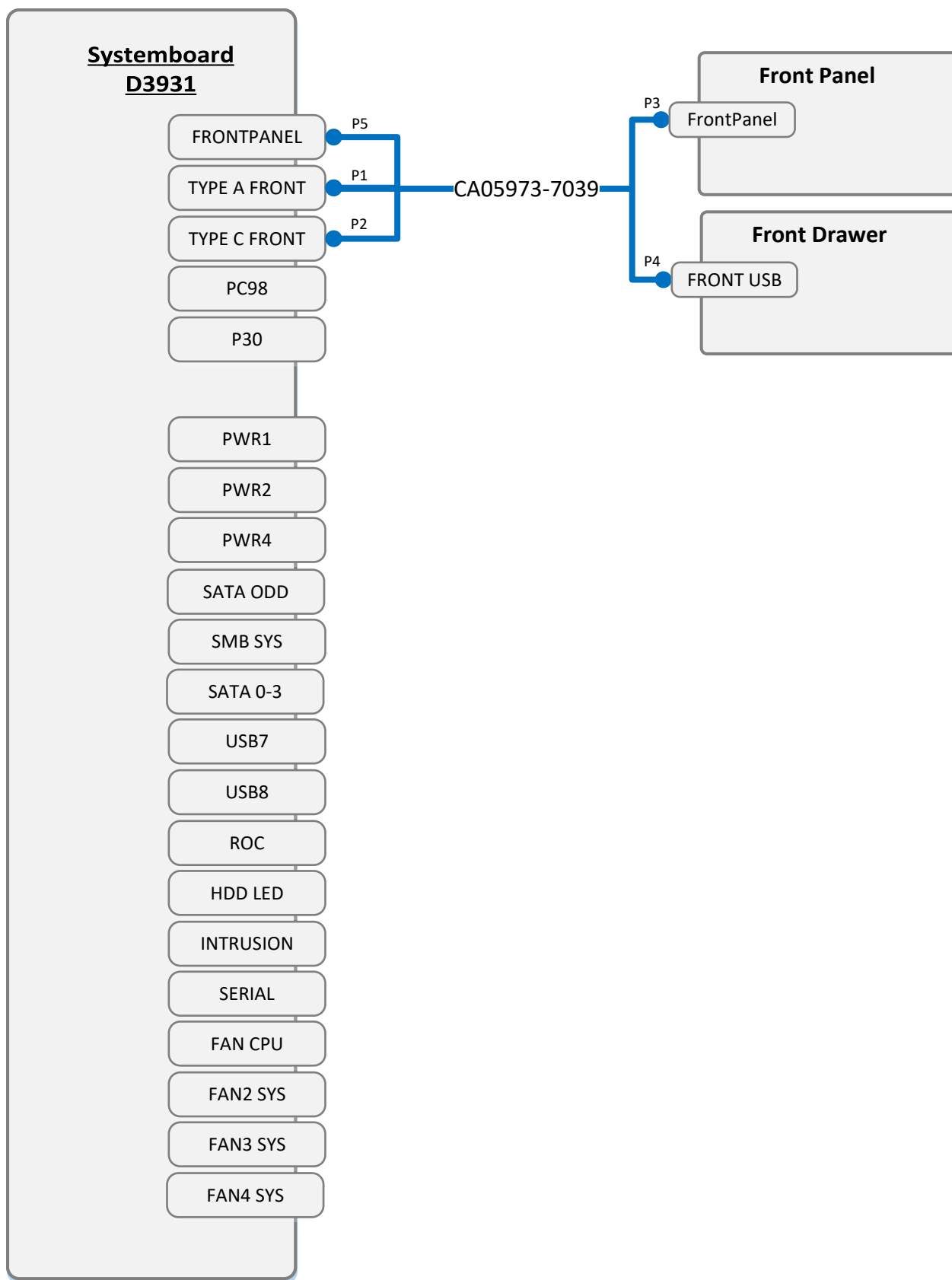

BasicCablingStdPSU

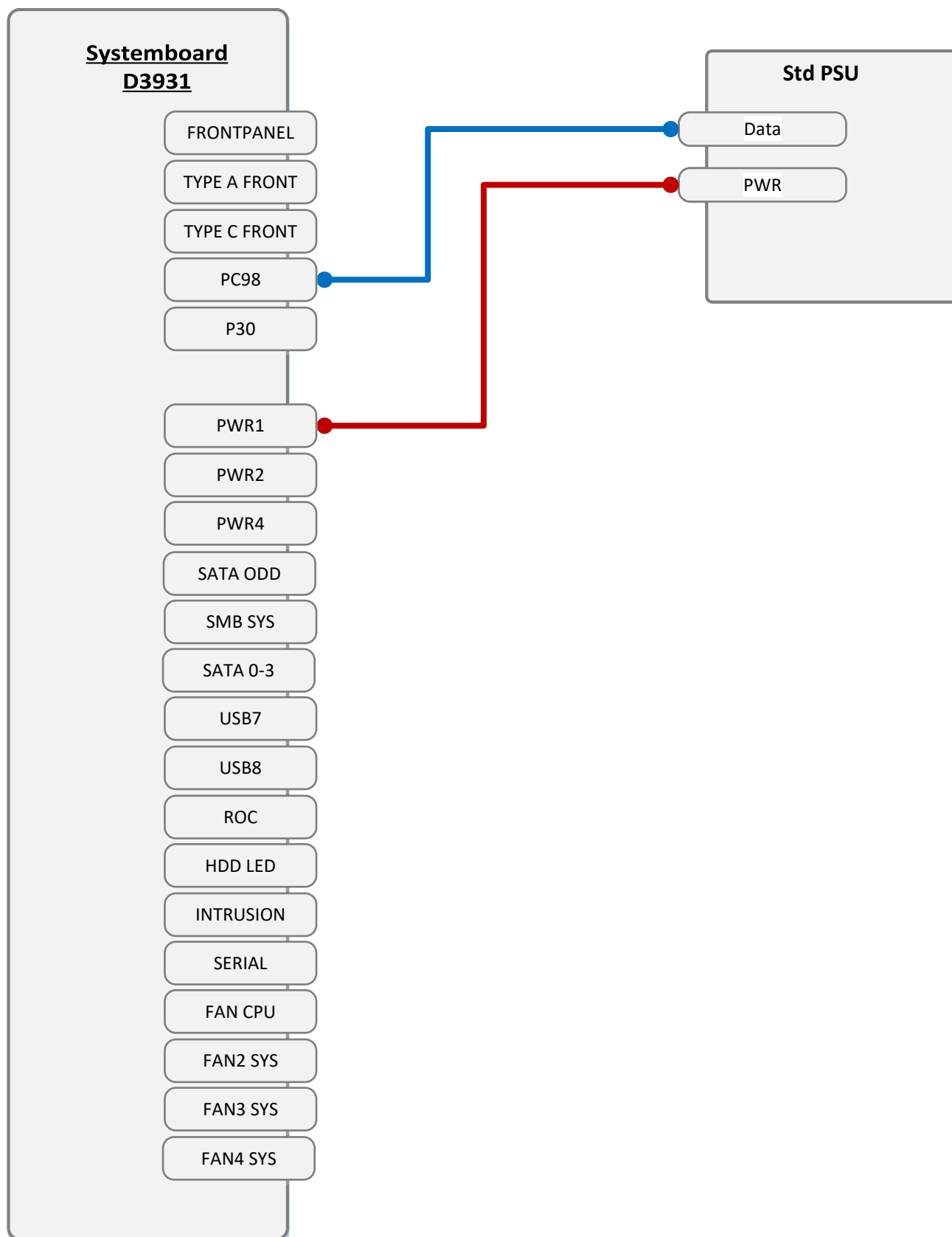

BasicCablingRedPSU

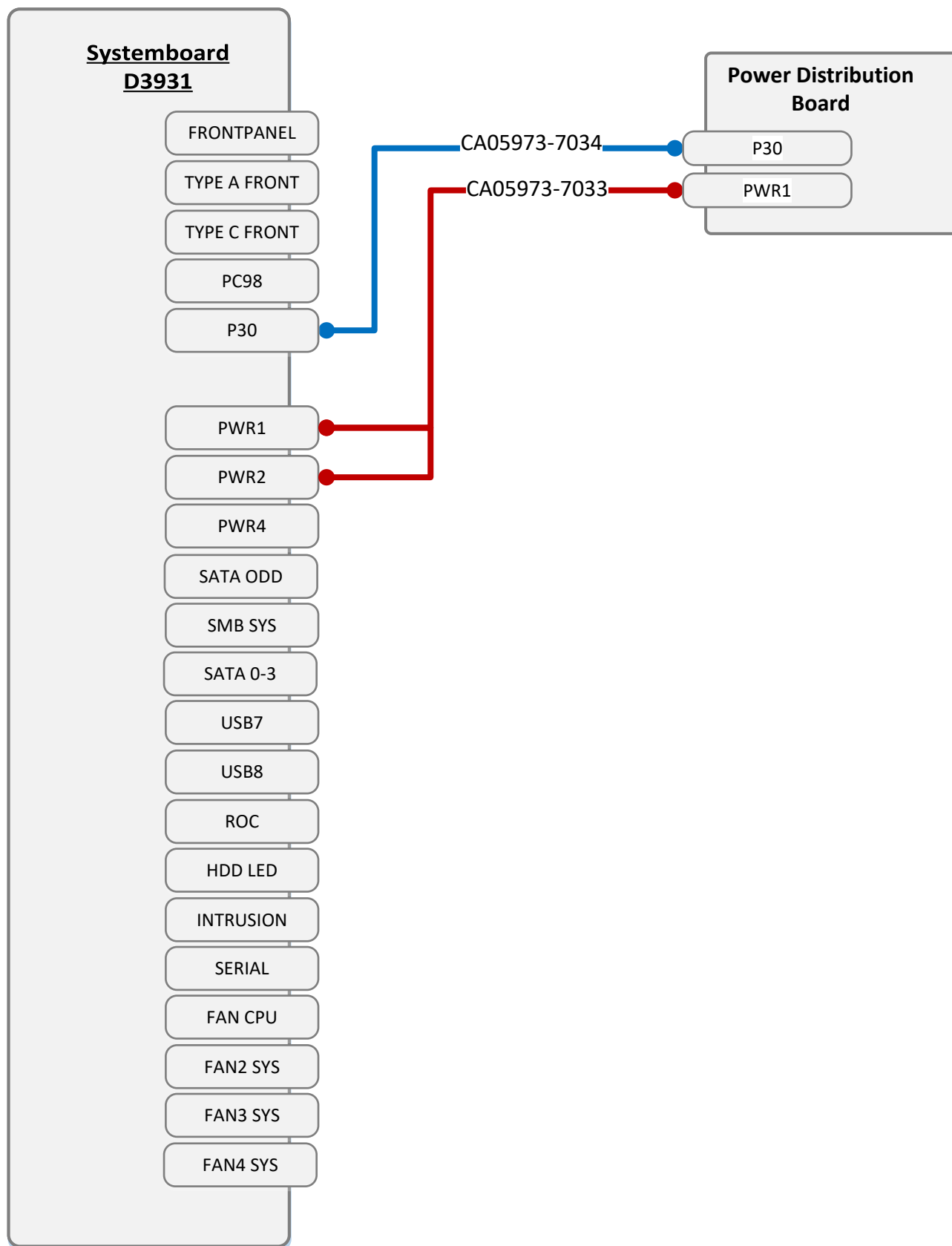

PowerCabling3.5HDD

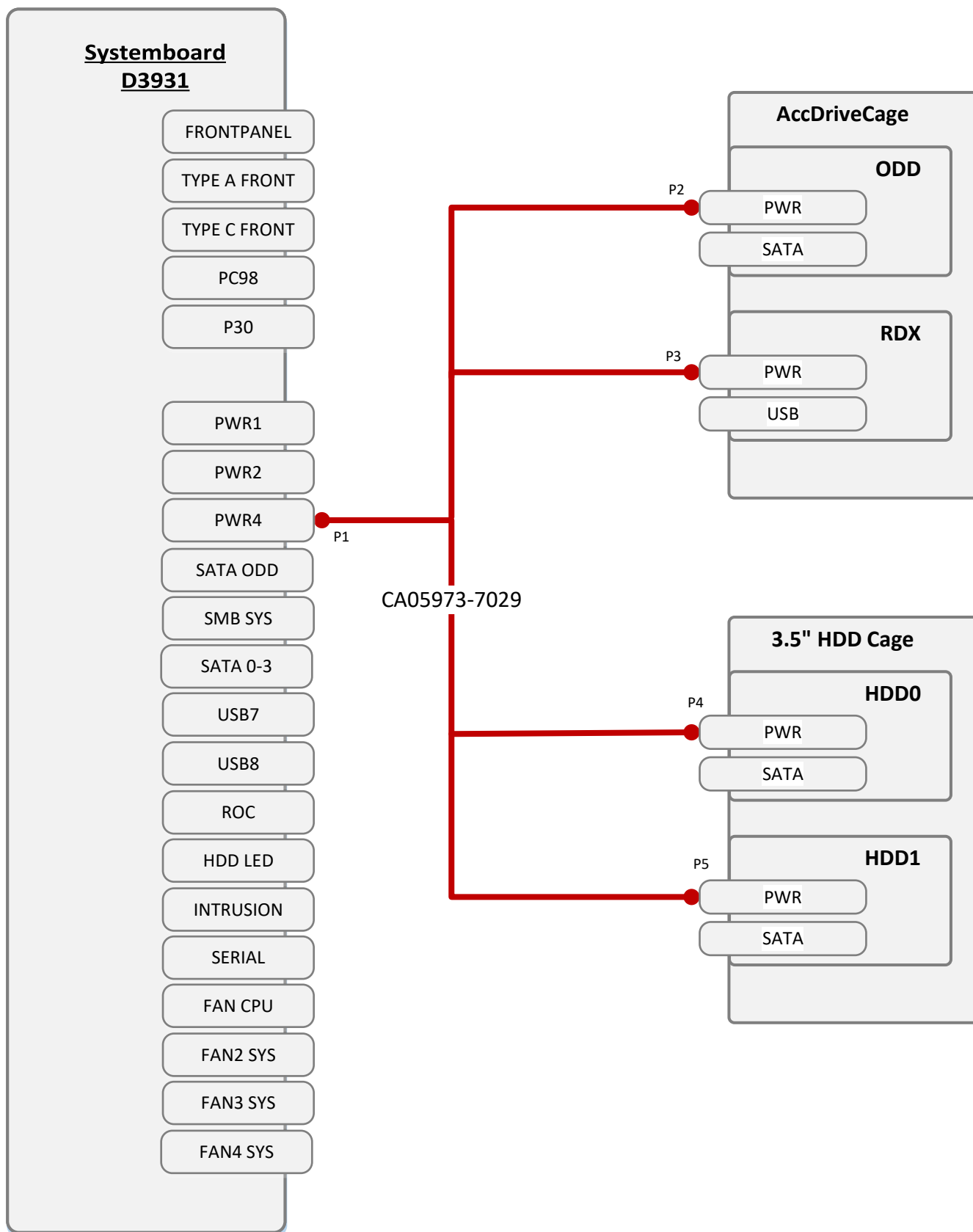

PowerCabling2.5HDD

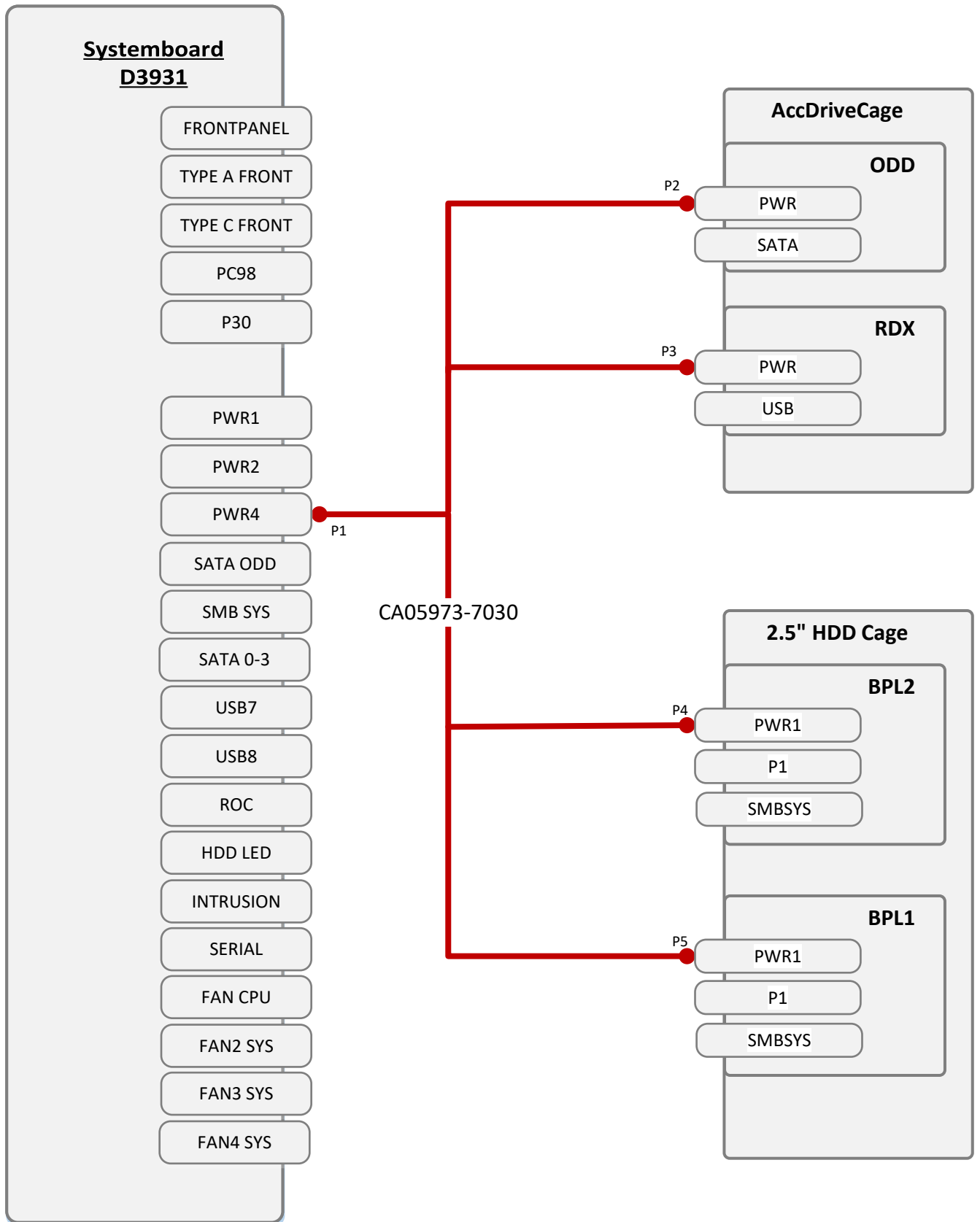

PowerCabling 2.5HDD with NVMe

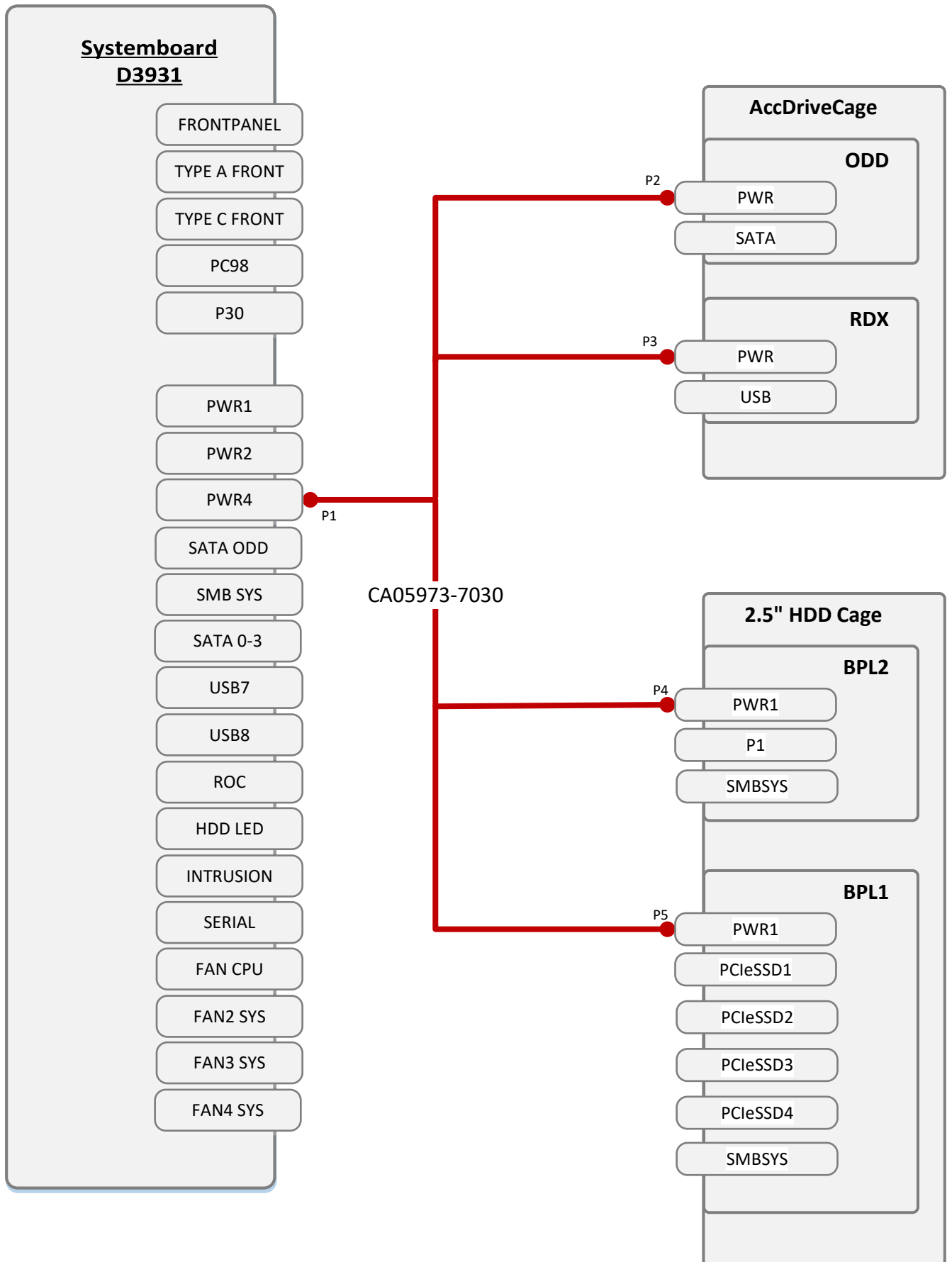

OOB Cabling 2.5 HDD

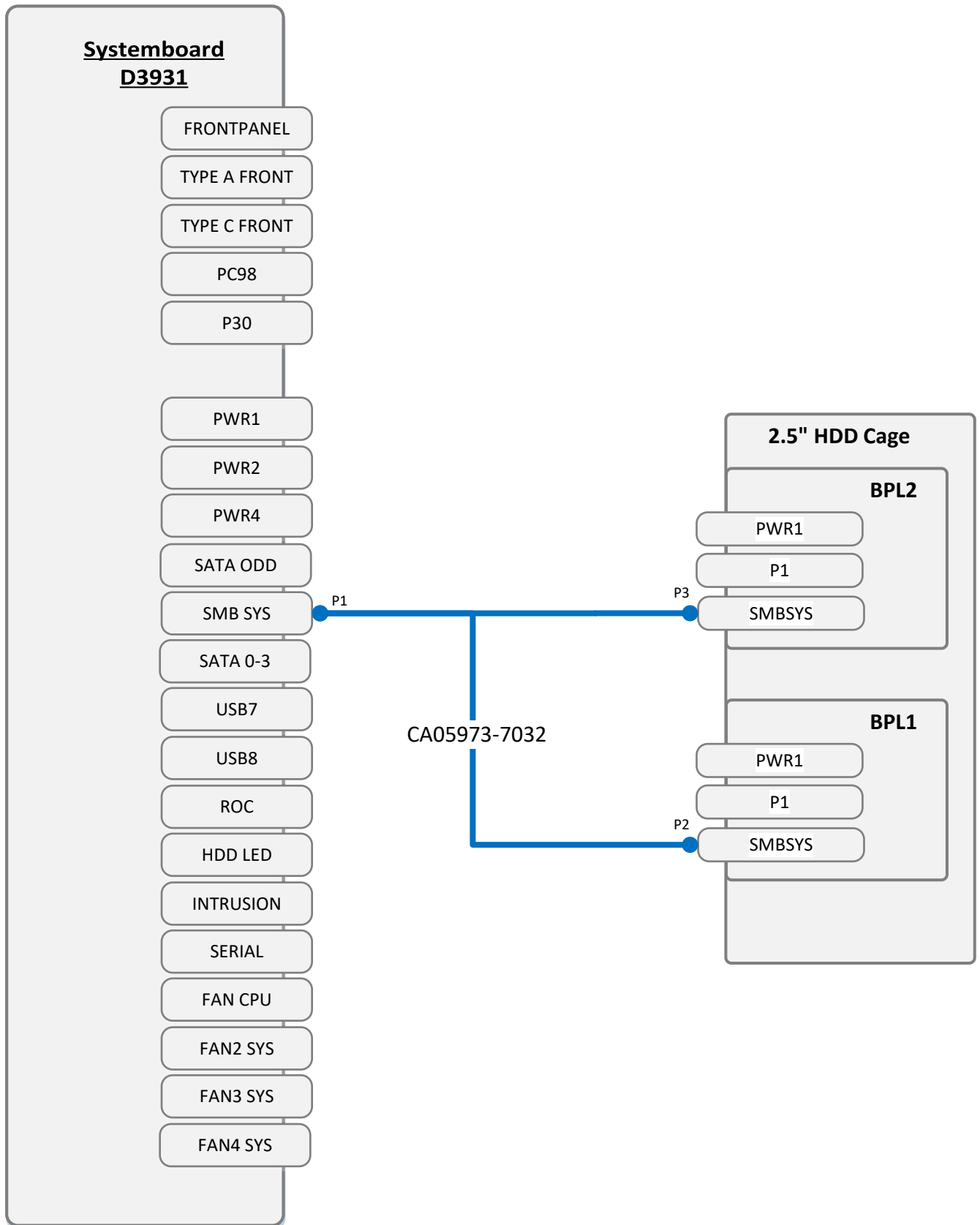

OOB Cabling 2.5HDD with NVMe

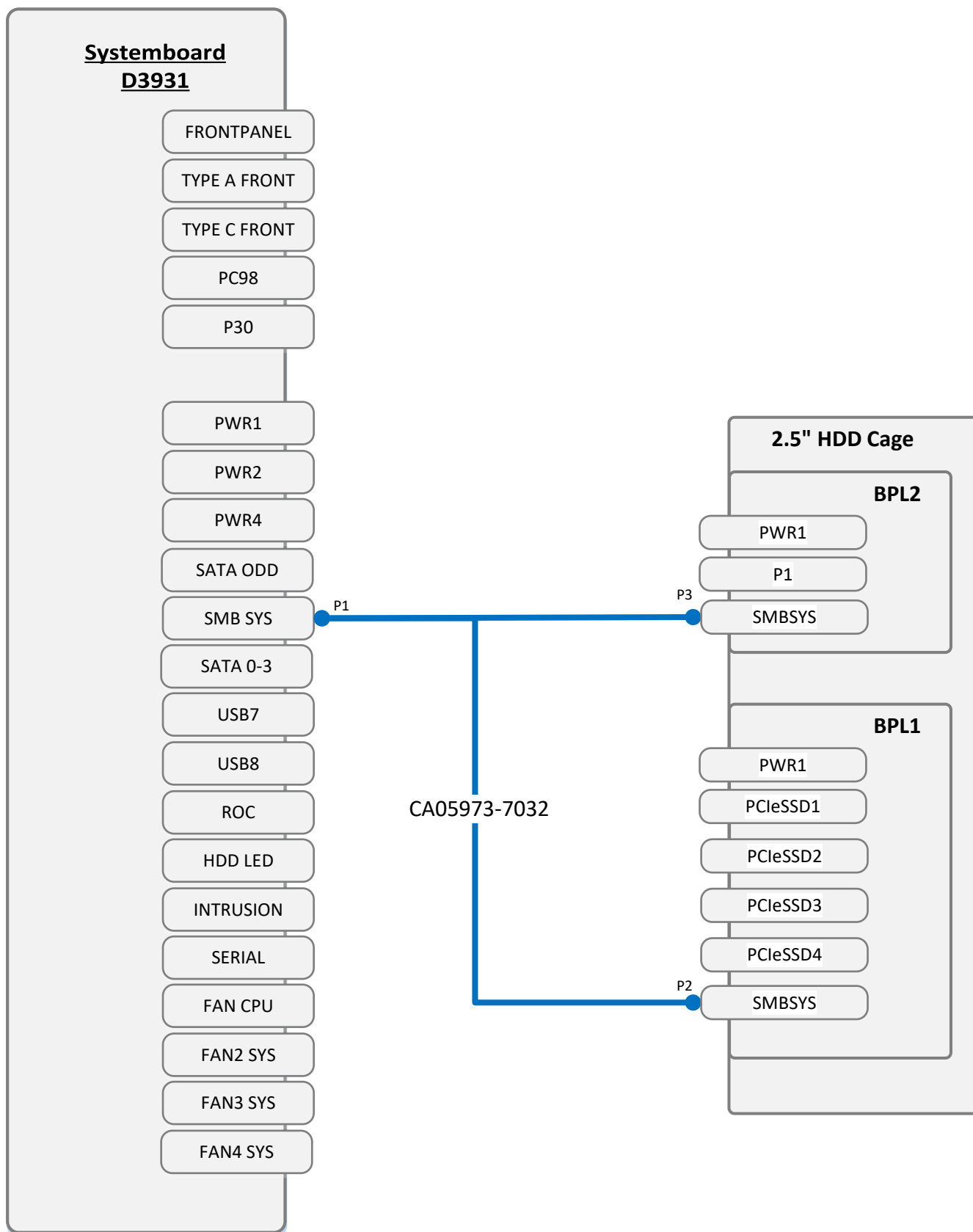

AccDrv_ODD_RDX

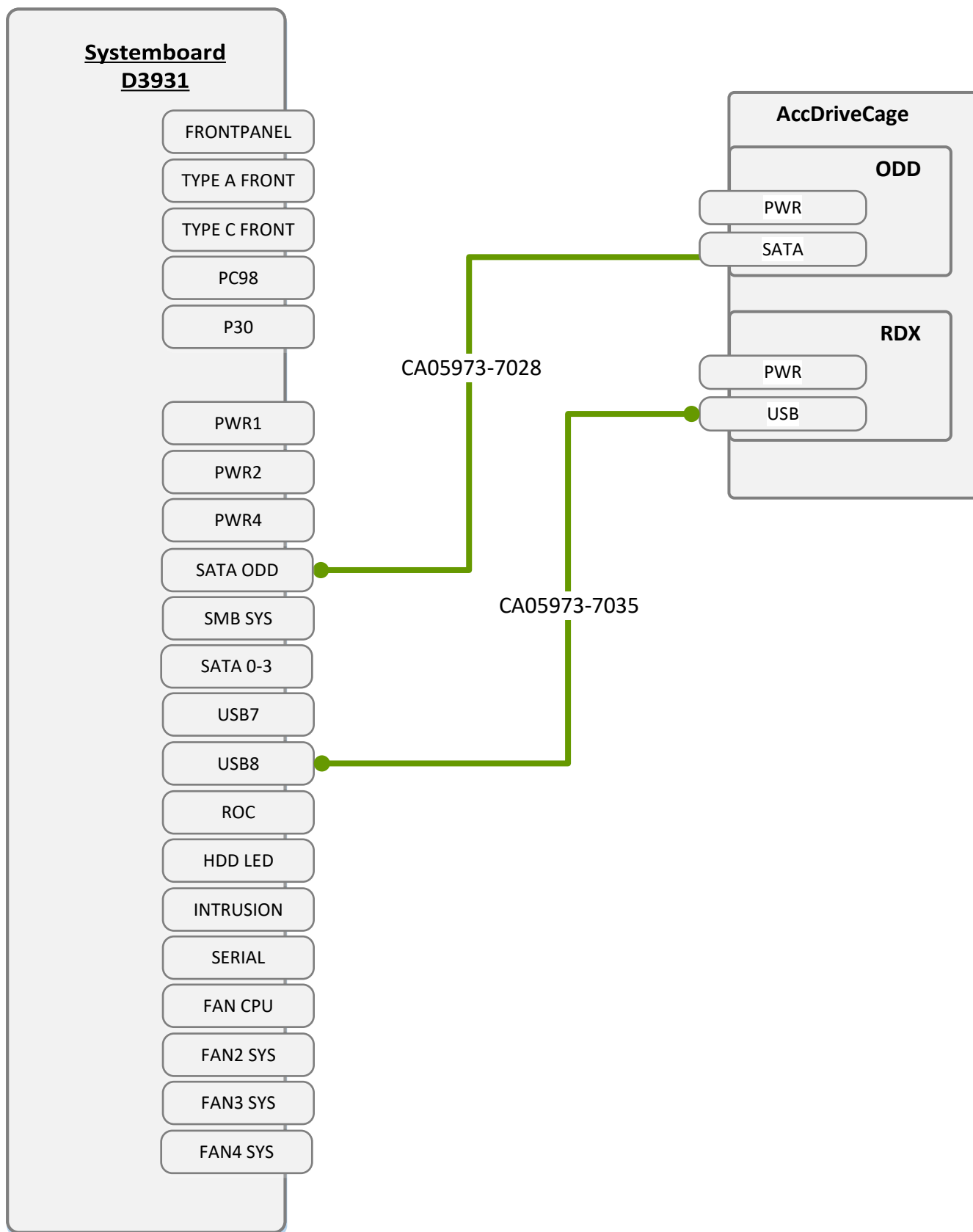

Data FBU

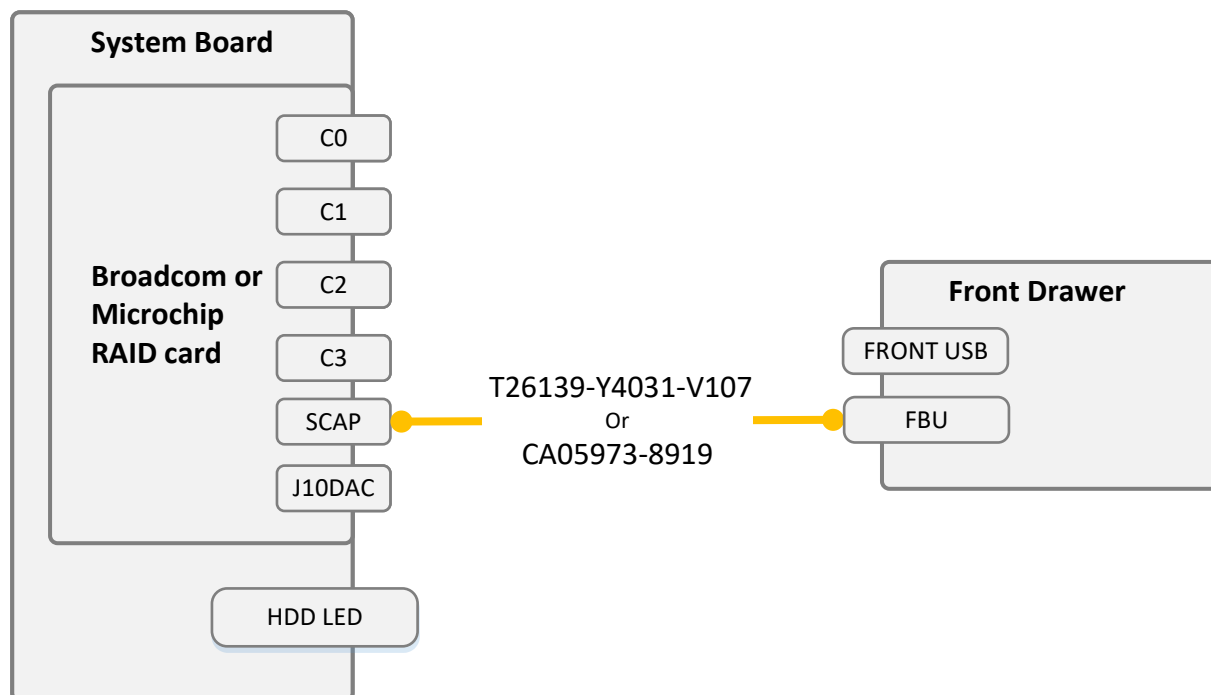
**If Installed Broadcom card**

EP5x0i/e or EP6x0i/e

Cable: T26139-Y4031-V107

If Installed Microchip card

EP 3258-16i/3254-8i/3252-8i

Cable: CA05973-8919

Data HDD Activity

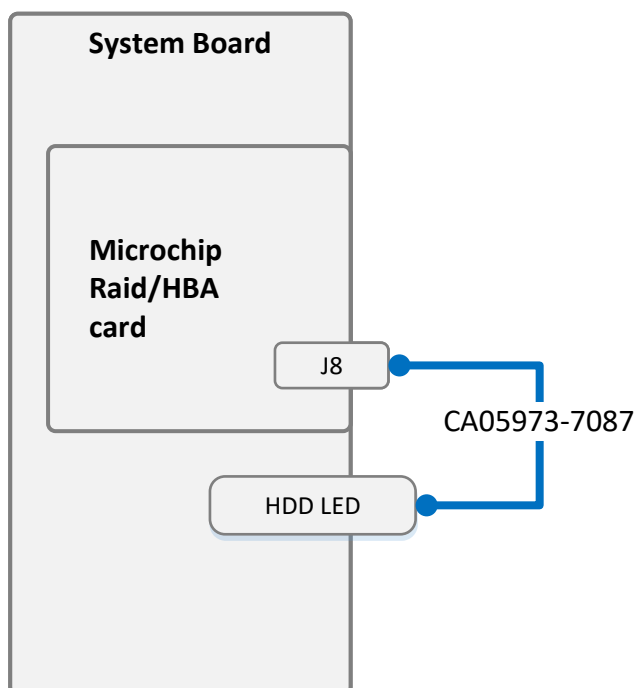
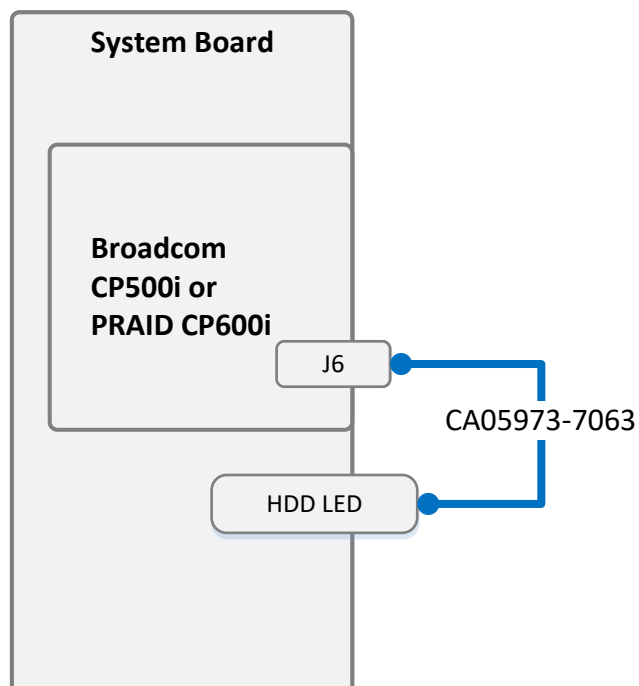
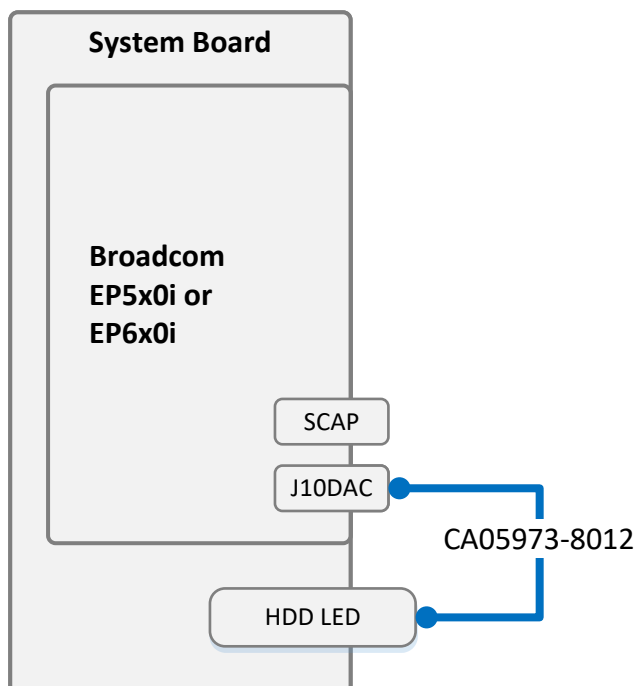

If Install Broadcom Raid card

- 1x EP5x0i Or EP6x0i =>
CA05973-8012
- 1x CP500i Or PRAID CP600i =>
CA05973-7063
- 2x PRAID cards =>
CA05973-7064
- J10: EP5xxi/ EP6xxi/ PRAID CP600i
- J6: PRAID/ CP500i

If install Microchip Raid card

- 1x Microchip card =>
CA05973-7087
- 2x Microchip card =>
CA05973-7088

Data 3.5_2xSATA_OnBoard

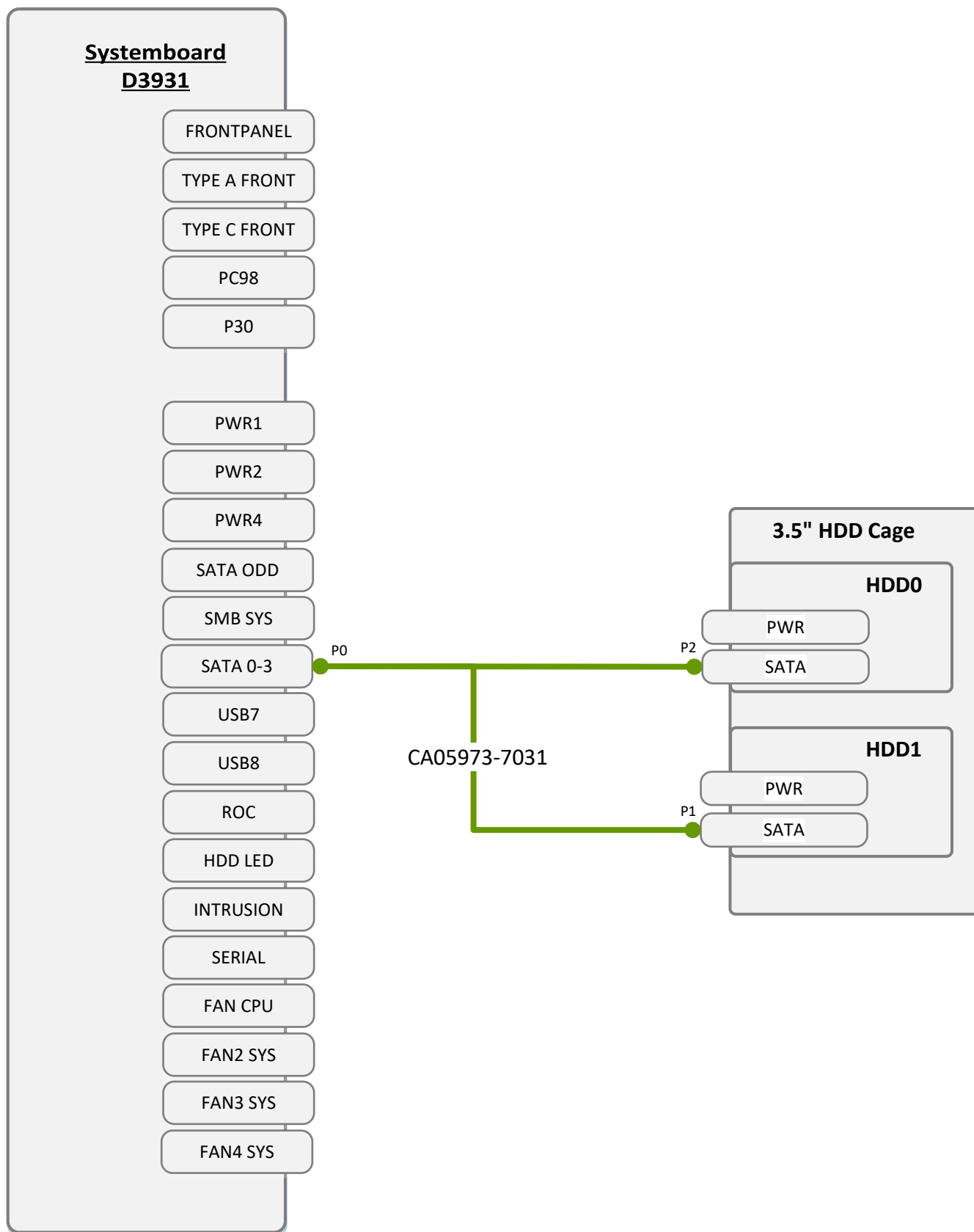

Data 3.5_2xSATA_MiniSAS HD HBA/RAID

C0/C1: for Broadcom CP/EP5x0i
NC0/NC1: for Microchip CP2100-8i

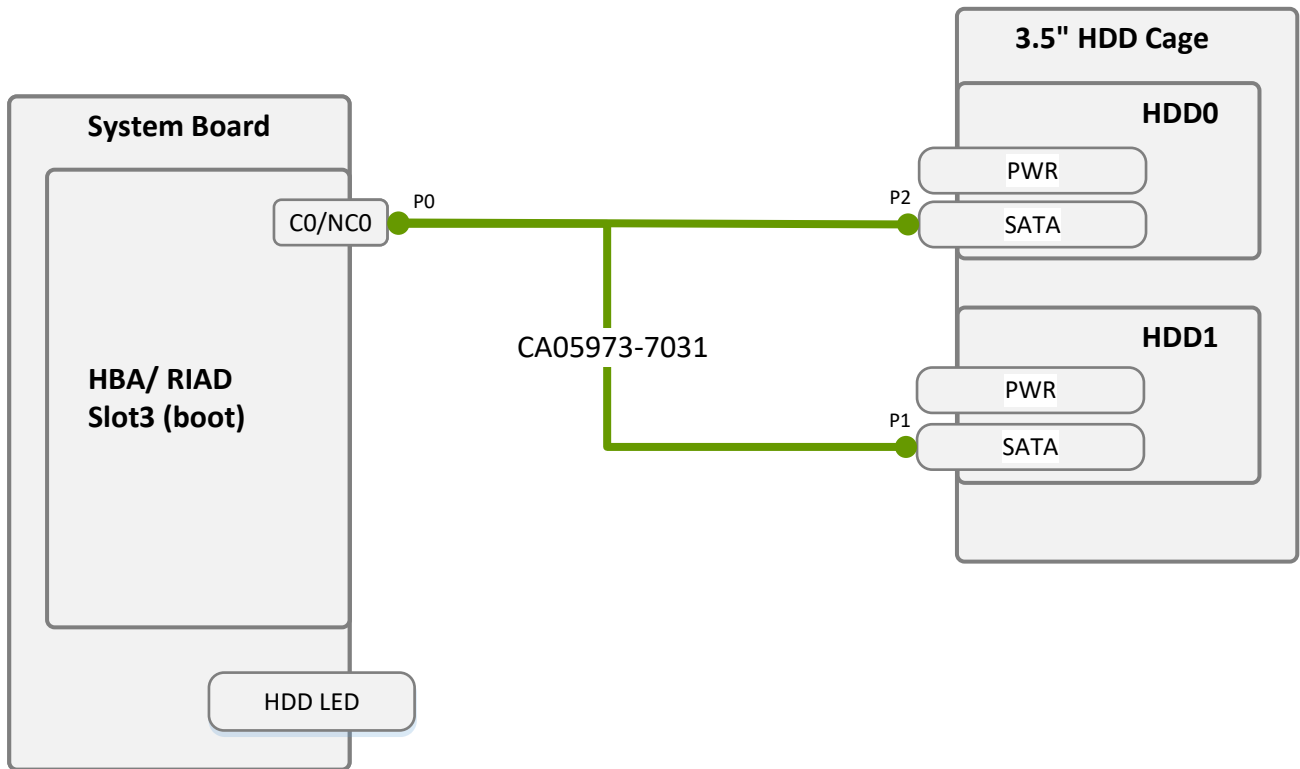

Data 3.5_2xSATA_SlimSAS HBA/RAID

C0/C1: for Broadcom CP/EP6x0i

PORT1/ PORT2: for Microchip 3258-16i/3254-8i/3252-8i/2200-16i

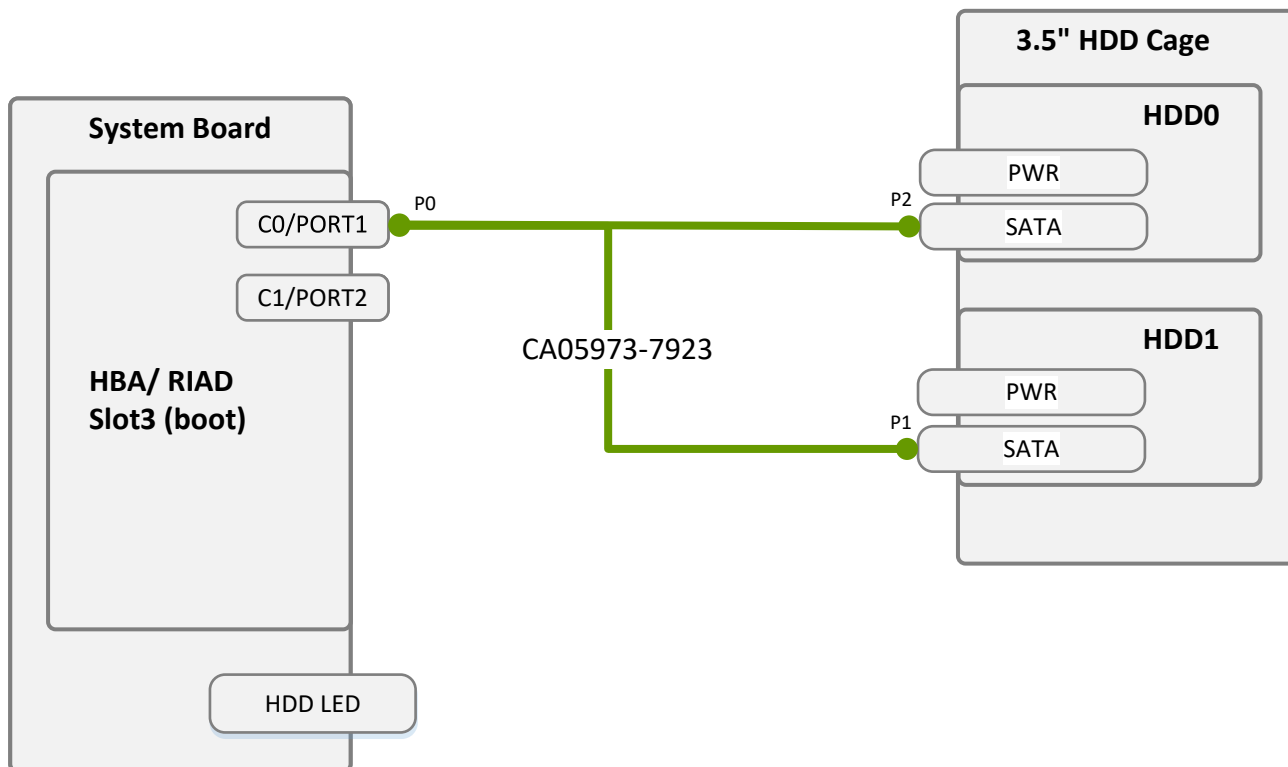

Data 2.5_4xSATA_OnBoard

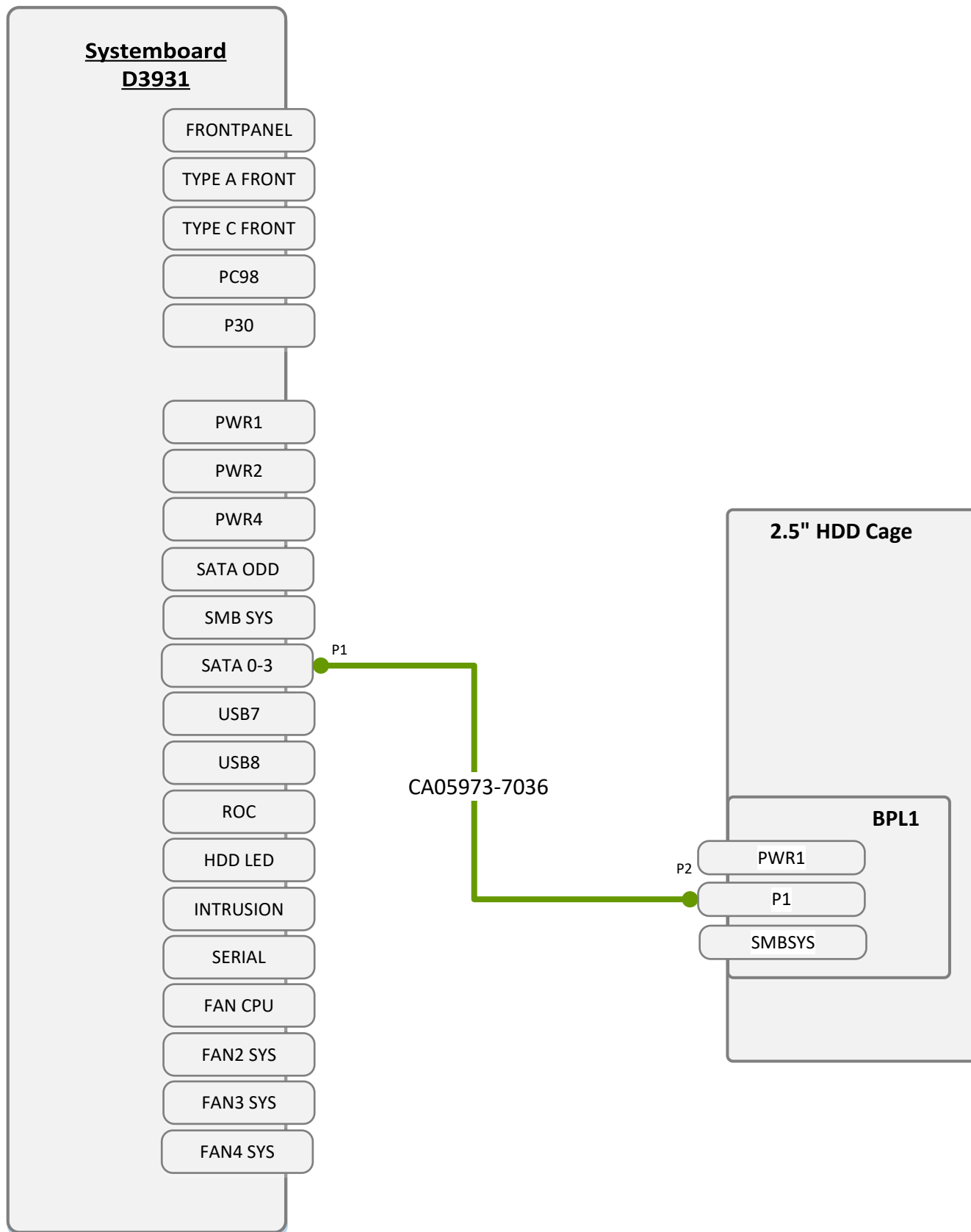

Data 2.5_4xSAS/SATA_MiniSAS HD HBA/RAID

C0: for Broadcom CP/EP5x0i
NC0: for Microchip CP2100-8i

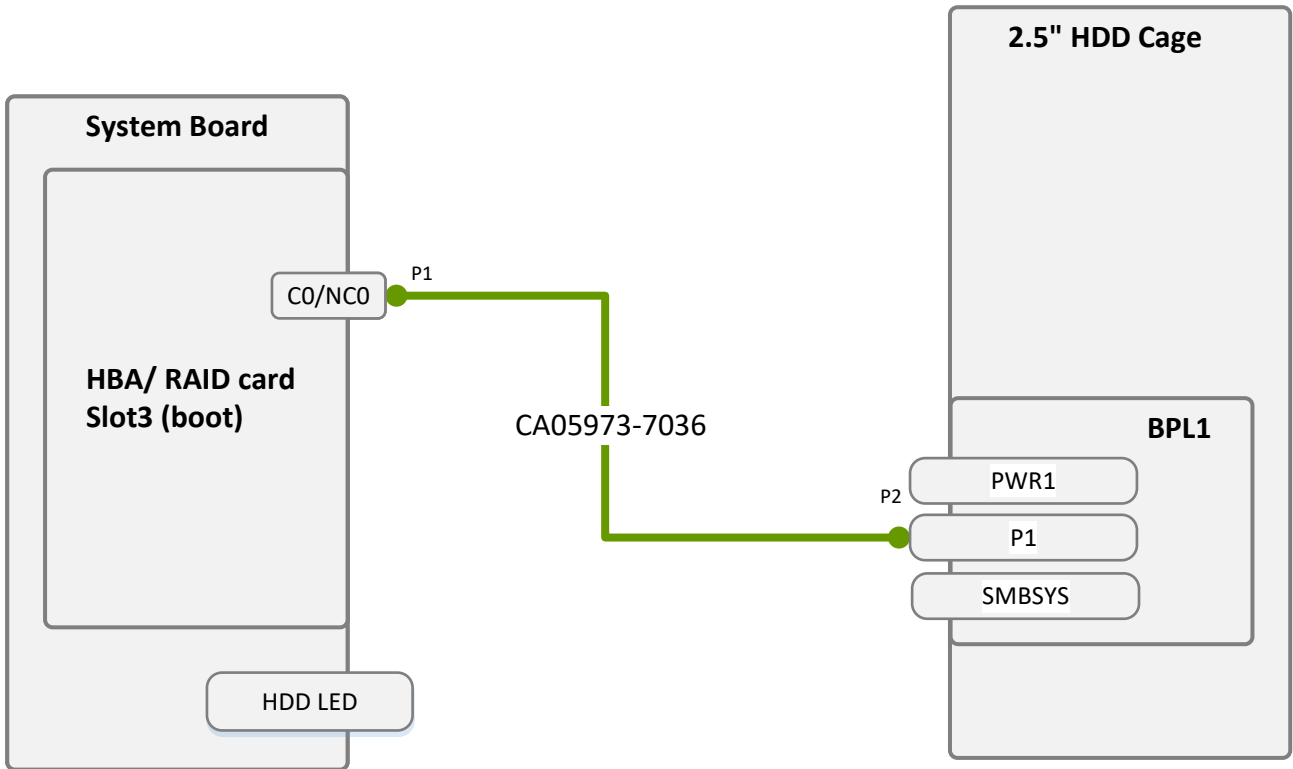

Data 2.5_4xSAS/SATA_SlimSAS HBA/RAID

C0/C1: for Broadcom CP/EP6x0i

PORT1/ PORT2: for Microchip 3258-16i/3254-8i/3252-8i/2200-16i

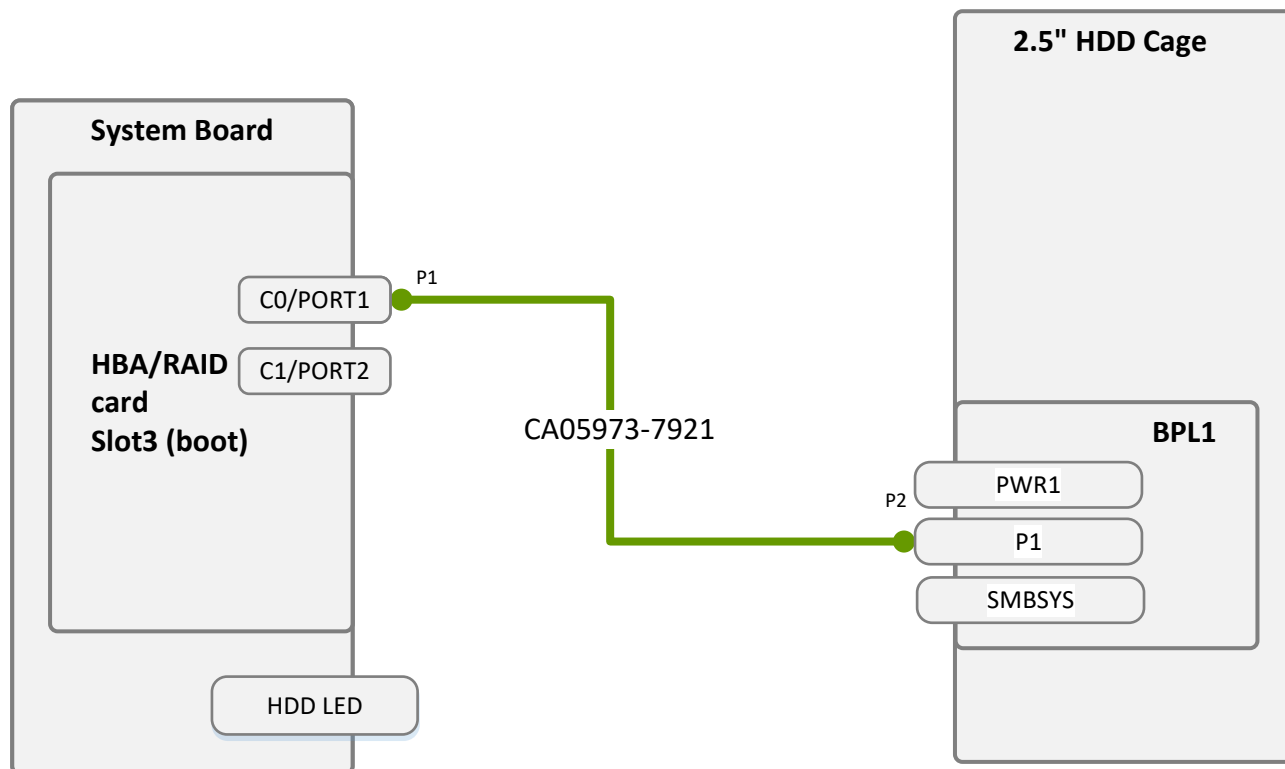

Data 2.5_8xSAS/SATA_MiniSAS HD HBA/RAID

C0/C1: for Broadcom CP/EP5x0i
 NC0/NC1: for Microchip CP2100-8i

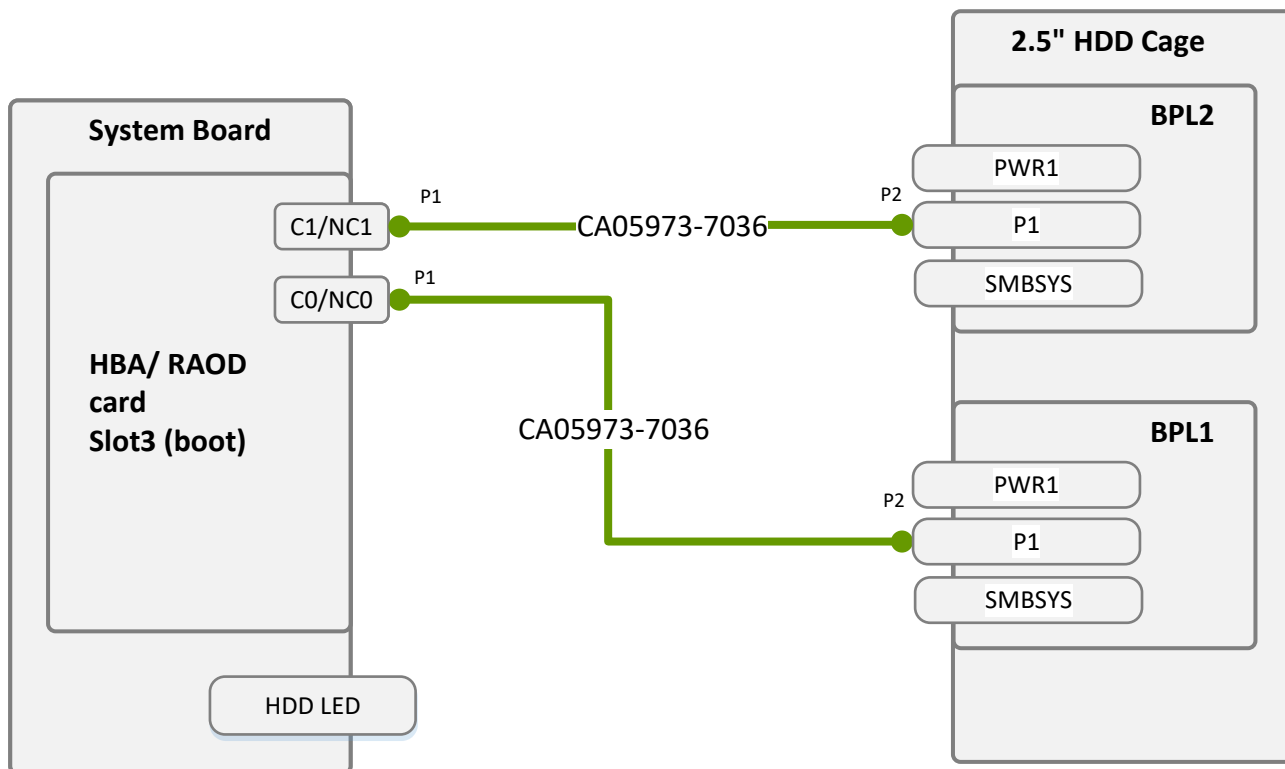

Data 2.5_8xSAS/SATA_SlimSAS HBA/RAID

C0/C1: for Broadcom CP/EP6x0i

PORT1/ PORT2: for Microchip 3258-16i/3254-8i/3252-8i/2200-16i

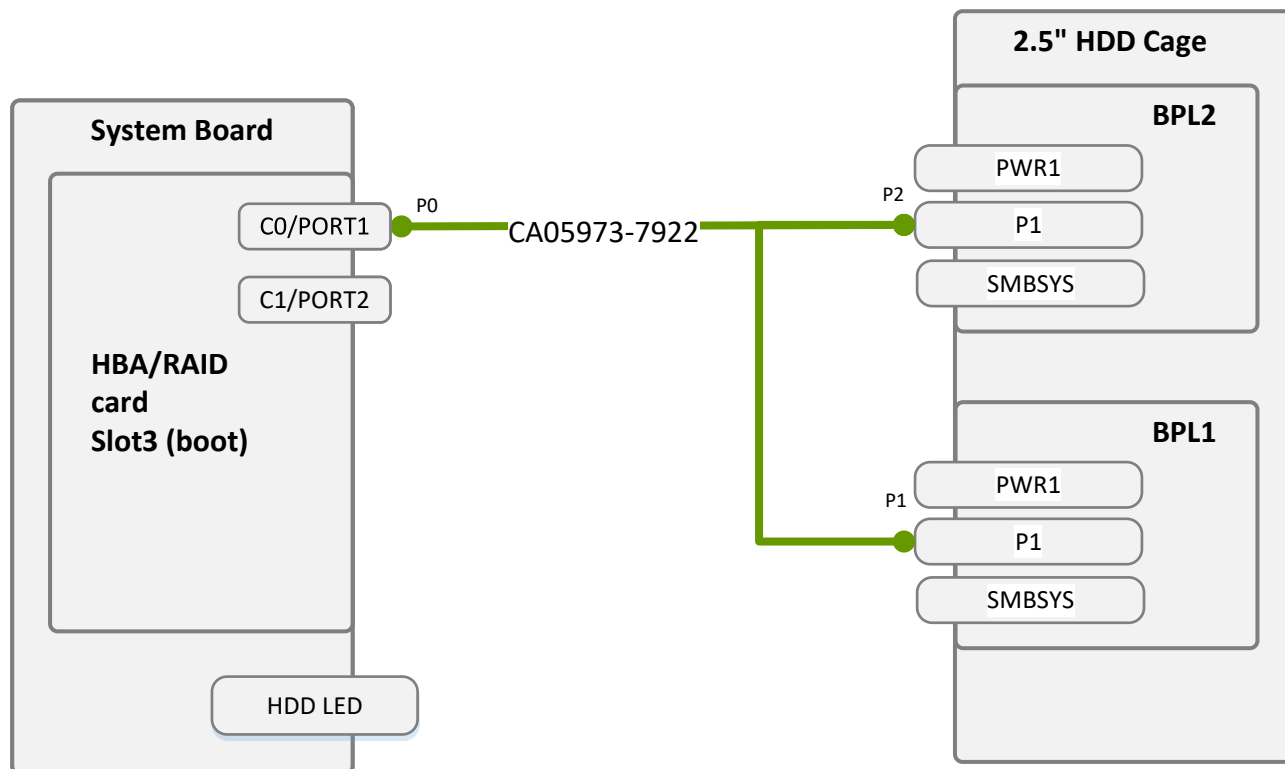

Data 2.5_4xNVMe_4xSAS/SATA_EP5x0i

C0: for Broadcom CP/EP5x0i

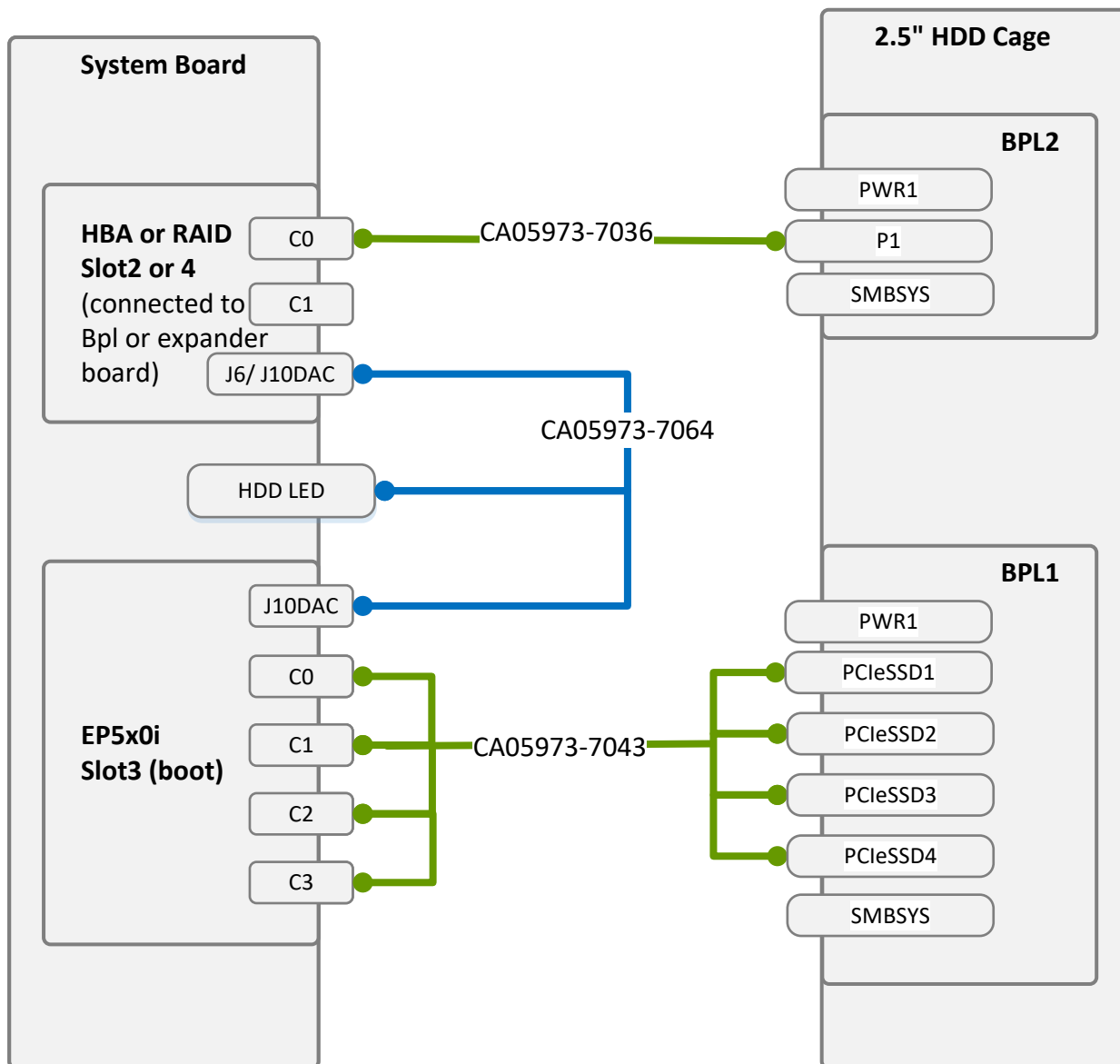

In this case
 CP500i -> J6 connector is used
 EP5x0i -> J10DAC is used.
 apply HDD LED Cable
 CA05973-7064

Data 2.5_4xNVMe_4xSAS/SATA_EP6x0i/3258-16i

C0/C1: for Broadcom CP/EP6x0i

PORT1/ PORT2: for Microchip 3258-16i/3254-8i/3252-8i/2200-16i

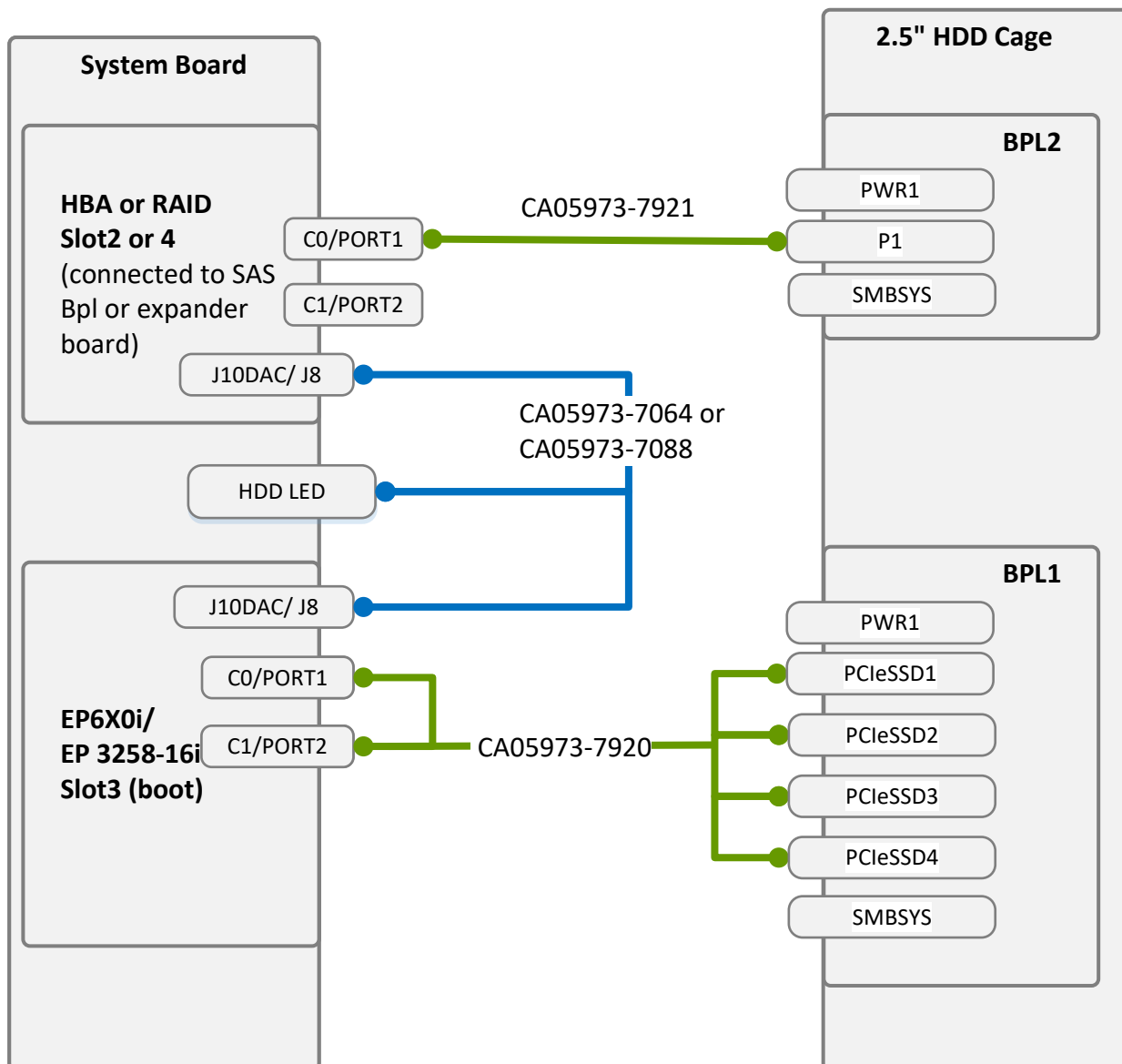

In this case
 apply HDD LED Cable
 CA05973-7064 (J10DAC) for Broadcom card or
 CA05973-7088 (J8) for Microchip card

System FANs

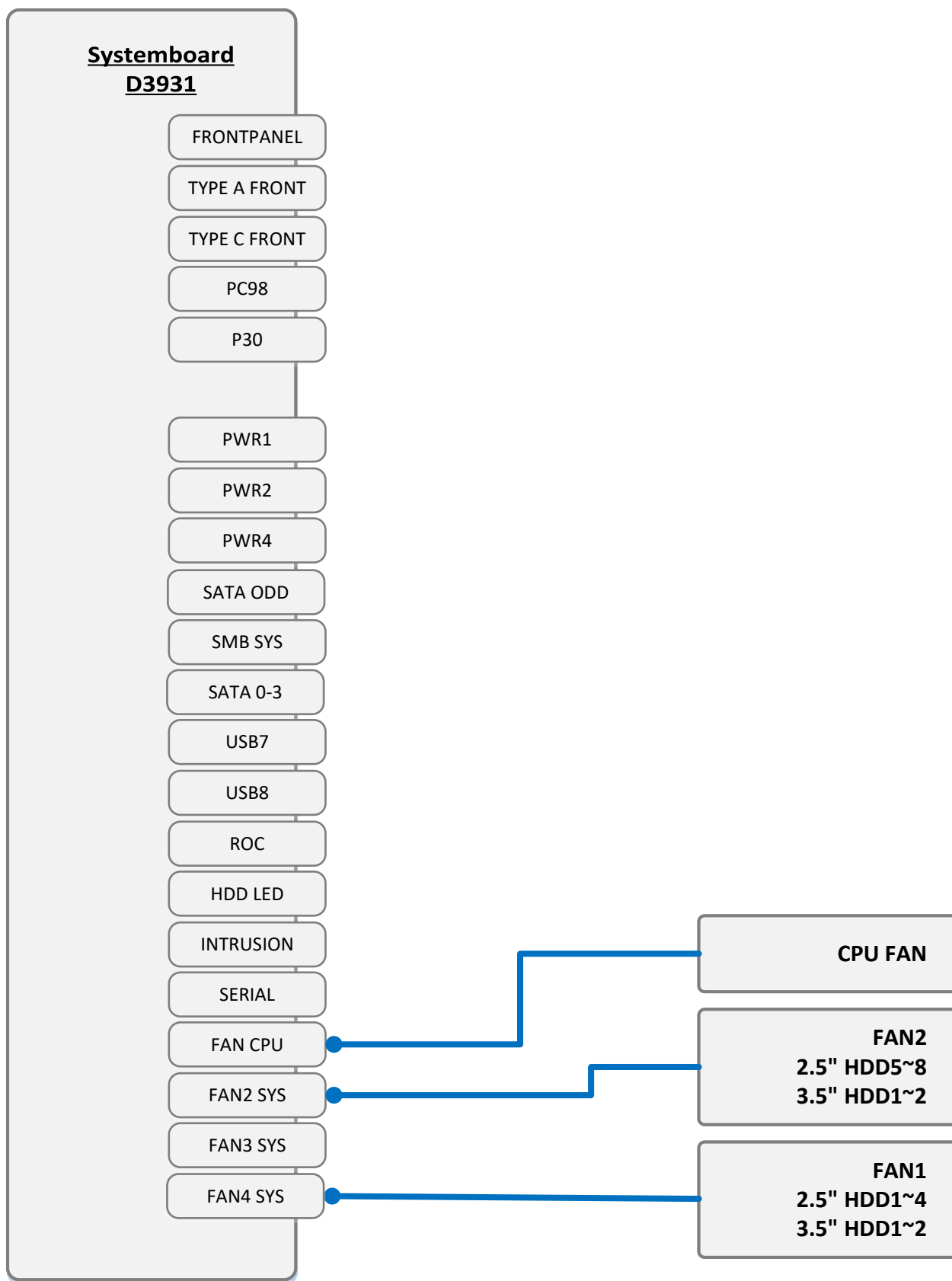

Serial Port

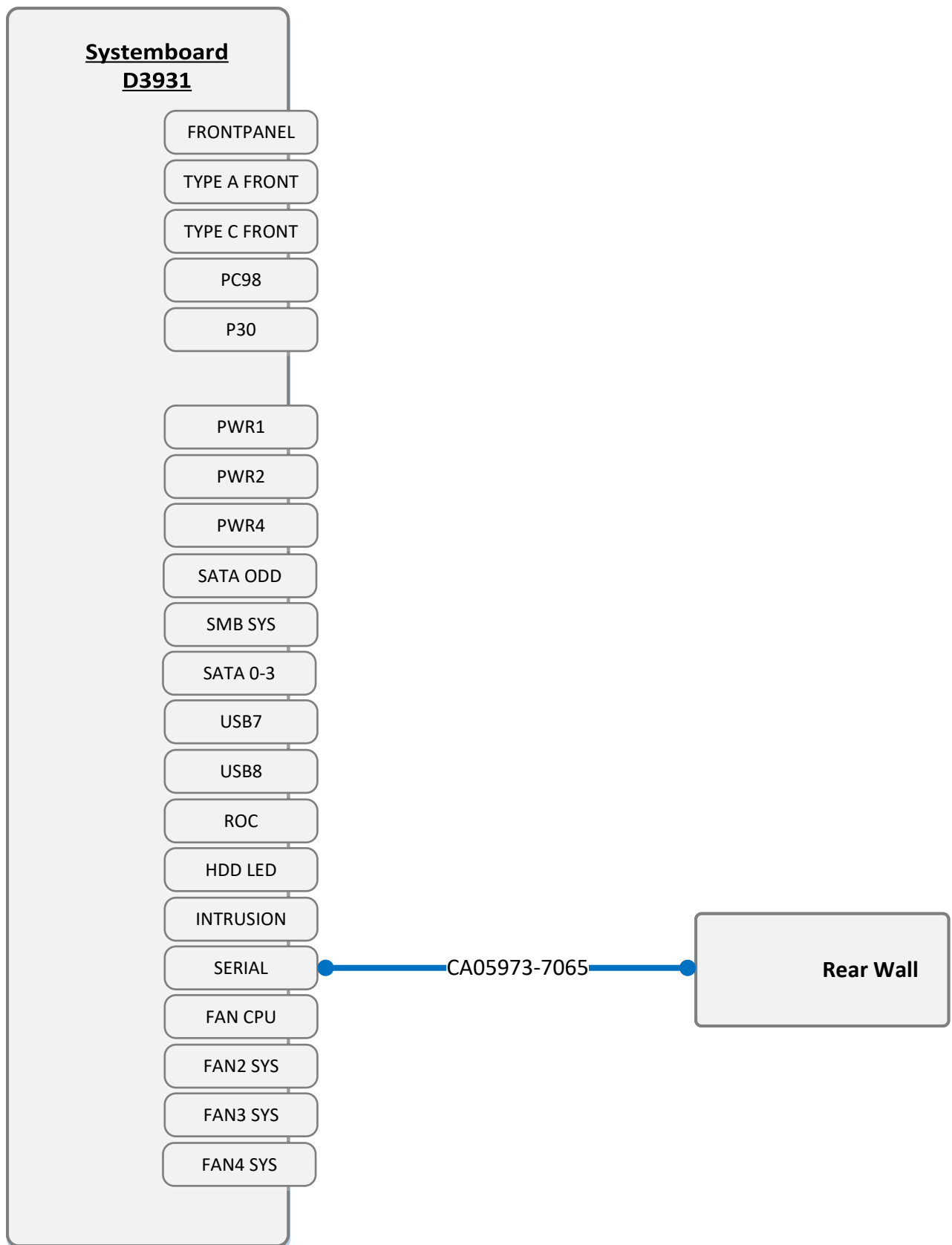

System Name: PRIMERGY TX1320 M5

CPU sockets 1



#PCIe Slots of system 4

Riser Option support n

Overview and properties of System PCI devices and slots

List of Released Adapters incl. Installation sequence and priority

				System PCI Slot #					
				1	2	3	4	M.2 SSD1	M.2 SSD2
				PCH	PCH	CPU	CPU	PCH	PCH
				n	n	n	n	n	n
Adapter Class Category	Adapter Installation Sequence Order within Adapter Category (Cluster)	Adapter Product Name Description (Softwarepool)	Max # Adapter	1	2	3	4	M.2 SSD1	M.2 SSD2
Solid-State-Drive									
	1	SSD SATA 6G <Capacity > M.2 N H-P for VMware	1	-	-	-	-	1	-
	2	SSD SATA 6G <Capacity > M.2 N H-P	1	-	-	-	-	1	-
			2	-	-	-	-	1	2
	3	SSD SATA 6G 240GB M.2 N H-P for VMware	1	-	-	-	-	1	-
	4	Micron 5400	1	-	-	-	-	1	2
	6	SSD PCIe4 M.2 N H-P	1	-	-	-	-	1	-
Controller Card – Graphic									
	1	NVIDIA A2	1	-	-	-	1	-	-
	2	NVIDIA T400 4GB	1	-	-	-	1	-	-
	3	NVIDIA T400 2GB	1	-	-	-	1	-	-
Controller Card - PCIe-Switch									
	1	PRAID EP580i NVMe function	1	-	-	1	-	-	-
	2	PRAID EP540i NVMe function	1	-	-	1	-	-	-
	3	PRAID EP 3258-16i NVMe	1	-	-	1	-	-	-
	4	PRAID EP680i NVMe	1	-	-	1	-	-	-
Controller Card - SAS int									
	1	PSAS CP503i	1	-	3	1	2	-	-
	2	PSAS CP600i	1	-	3	1	2	-	-
	3	PSAS CP 2100-8i	1	-	3	1	2	-	-
Controller Card - SAS RAID int									
	1	PRAID CP500i	1	-	3	1	2	-	-
	2	PRAID EP580i	1	-	3	1	2	-	-
	3	PRAID EP540i	1	-	3	1	2	-	-
	4	PRAID EP520i	1	-	3	1	2	-	-
	5	PRAID EP 3252-8i	1	-	3	1	2	-	-
	6	PRAID EP 3254-8i	1	-	3	1	2	-	-
	7	PRAID EP 3258-16i	1	-	3	1	2	-	-
	8	PRAID CP600i	1	-	3	1	2	-	-
	9	PRAID EP640i	1	-	3	1	2	-	-
	10	PRAID EP680i	1	-	3	1	2	-	-
Controller Card - LAN									
	1	PLAN EP E810-XXVDA2 2X 25G SFP28 PCIe	2	4	3	2	1	-	-
	2	PLAN EP X710-T2L 2X 10GBASE-T PCIe	2	4	3	2	1	-	-
	3	PLAN EP X710-T4L 4X 10GBASE-T PCIe	2	4	3	2	1	-	-
	4	PLAN EP MCX4-LX 25Gb 2p SFP28	2	4	3	2	1	-	-
	5	PLAN EP X710-DA4 4x10Gb SFP+	2	4	3	2	1	-	-
	6	PLAN EP X710-DA2 2x10Gb SFP+	2	4	3	2	1	-	-
	7	PLAN CP 4x1Gbit Cu Intel I350-T4	2	2	1	-	-	-	-
	8	PLAN CP 2x1Gbit Cu Intel I350-T2	2	2	1	-	-	-	-
	9	PLAN EP P210TP 2X 10GBASE-T PCIe	2	4	3	2	1	-	-
	10	PLAN EP P210P 2x10Gb SFP PCIe	2	4	3	2	1	-	-
	11	PLAN CP BCM5719-4P 4X 1000BASE-T PCIe	2	2	1	-	-	-	-
Controller Card - SATA RAID									
	1	PDUAL CP100	1	1	2	3	4	-	-

Item	Screw driver	Screw picture	Usage	Type	Q'ty	Torque / Tolerance (Nm) +/-10%	Fujitsu P/N	ODM P/N	Refer to Fujitsu screw
1	Phillips PH2		MB : 8pcs PDB : 1pcs 4x2.5" SAS-SATA BP : 2pcs / 1PCBA 4x2.5" NVMe BP : 2pcs / 1PCBA Std. PSU & Kits : 6pcs RPSU Cage : 4pcs 2.5" HDD Cage Cover : 4pcs Dust Filter Kits : 5pcs USB Cable : 2pcs	M3 x 4.5 mm	34	0.6 Nm	C26192-Y10-C67	C26192-Y10-C67	S306
2	Phillips PH1		DVD latch x 2	M2 x 4 mm	2	0.09 Nm	A3C40191083	N/A	S202
3	Hexagon head		Serial port : 2pcs	#4-40 x 6.8 mm	2	0.2 Nm	N/A (packing with Serial port cable)	N/A (packing with Serial port cable)	S607

List of screws used in PRIMERGY Servers

Assembled in Czech and Japan

June 2022

List of screws used in PRIMERGY Servers, assembled in WCZ or FIT

screw reference number	WCZ	FIT	code number	type	photo	head tool / insert bit	color	Torque tolerance +10%
S101	x	x	N/A	M1.6 x 4 mm		Phillips PH1	silver	0.2 Nm
S201	X		EOL: C26192-Y10-C62 C26192-Y10-C163	M2 x 2.5 mm		Torx 6 Plus	silver	0.2 Nm
		X	F6-SNA2-03121	M2 x3 mm		Torx 6 Plus	silver	0.2 Nm
S202	X		C26192-Y10-C112	M2 x 4 mm countersink		Phillips PH1	silver	0.09 Nm
		X	F6-SW4N2-03121	M2 x 4 mm countersink		Phillips PH1	silver	0.09 Nm
S203	X		C26192-Y10-C166	M2 x 4 mm		Torx 6 Plus	black	0.09 Nm
S204	X	X	C26192-Y10-C103 Replacement screw for A3C40137316 / LSZ: L3-25419-01	M2.5 x 4 mm		Phillips PH1 / JIS 1012 type H1	silver	0.4 Nm
S205	X	X	N/A	M2.5 x 6.5mm		Phillips PH1	silver	0.3 Nm

screw reference number	WCZ	FIT	code number	type	photo	head tool / insert bit	color	Torque tolerance +-10%
S206	X	X	N/A	M2 x 4.3mm		Phillips PH1	silver	0.2 Nm
S207	X	X	N/A	M2 x 4 mm countersink		Phillips PH1	black	0.09 Nm
S208	X	X	N/A	M2.5 x 8 mm self-tapping		Phillips PH1	black	0.4 Nm
S301	X		C26192-Y10-C151	M3 x 3.5 mm		hexagon head 5 mm / cross PZ2	black	0.6 Nm
		X	F6-SW2N3-05121	M3 x 5 mm with spring and washer		Phillips PH2	silver	0.6 Nm
S302	X		C26192-Y10-C102	M3 x 3.5 mm		Phillips PH1	silver	0.4 Nm
		X	CA32432-0023	M3 x 3.5 mm		Phillips PH1 / JIS 1012 type H1	silver	0.4 Nm
S303	X	X	A3C40109082	M3 x 4 mm		Phillips PH1	white	0.09 Nm
S304	X		A3C40142649	M3 x 4 mm countersink		countersink Phillips PH1	silver	0.4 Nm
S305	X	X	Screws in kit: S26361-D3305- A10	M3 x 4 mm		Phillips PH1	silver	0.4Nm

screw reference number	WCZ	FIT	code number	type	photo	head tool / insert bit	color	Torque tolerance +-10%
S306	X		C26192-Y10-C67	M3 x 4.5 mm		hexagon head 5 mm / cross PZ2	silver	0.6 Nm
		X	F6-SW2N3-05121	M3 x 5 mm with spring and washer		Phillips PH2	silver	0.6 Nm
S307	X		C26192-Y10-C68	M3 x 6 mm		hexagon head 5 mm / cross PZ2	silver	0.6 Nm
		X	F6-SW2N3-06121	M3 x 6 mm with spring and washer		Phillips PH2	silver	0.6 Nm
S308	X		C26192-Y10-C111	M3 x 6 mm		countersink Phillips PH1	silver	0.6 Nm
		X	F6-SSA3-06121	M3 x 6 mm		countersink Phillips PH1	silver	0.6 Nm
S309	X	X	C26192-Y10-C69	M3 x 8 mm		hexagon head 5 mm / cross PZ2	silver	0.6 Nm
S310	X		C26192-Y10-C207 same as -C67 but not "self-tapping"	M3 x 4.5 mm		hexagon head 5 mm / cross PZ2	silver	0.6 Nm
S311	X	X	C26361-B443- C220	M3 x 3.2 mm		Lens head screw cross PZ2	silver	0.2 Nm
S312	X	X	N/A	M3 x 6.7 mm		Phillips PH2	silver	0.6 Nm
S313	X	X	N/A	M3 Fastener Screw		Phillips PH2	silver	0.6 Nm

screw reference number	WCZ	FIT	code number	type	photo	head tool / insert bit	color	Torque tolerance +-10%
S314	X	X	N/A	M3 Captive Screw		Phillips PH2	silver	0.2 Nm
S315	X	X	N/A	M3 x 3 mm		Phillips PH1	silver	0.6 Nm
S316	X	X	N/A	M3 x 4 mm		Phillips PH2	silver	0.6 Nm
S317	X	X	N/A	M3 x 4.5 mm Ø8.0x16.5		Phillips PH2	silver	0.6 Nm
S318	X	X	N/A	M3 x 4 mm		Phillips PH2	silver	0.6 Nm
S319	X	X	N/A	M3 x 4.5 mm		Phillips PH2	silver	0.6 ~ 0.7 Nm
S320	X	X	N/A	M3 x 5 mm		Phillips PH2	silver	0.7 Nm
S321	X	X	N/A	M3 Captive Screw		Phillips PH2	silver	0.6 Nm

screw reference number	WCZ	FIT	code number	type	photo	head tool / insert bit	color	Torque tolerance +-10%
S322	X	X	CA05973-9652	M3 x 6 mm		Phillips PH2	silver	0.8 Nm
S323	X	X	N/A	M3 x 8 mm		Phillips PH2	silver	0.8 Nm
S324	X	X	N/A	M3 x 9 mm		Phillips PH2	silver	0.8 Nm
S325	X	X	N/A	M3 x 2.2 mm		Phillips PH2	silver	0.6 Nm
S326	X	X	CA05973-9653	M3 x 4 mm		Phillips PH2	silver	0.6 Nm
S327	X	X	N/A	M3 x 5.5 mm		Phillips PH2	silver	0.6 Nm
S328	X	X	N/A	M3 x 4.5 mm		Phillips PH2	silver	0.2 Nm
S329	X	X	N/A	M3 x 5 mm		Phillips PH2	silver	0.6 Nm
S330	X	X	A3C40121520	M3 x 5 mm		Phillips PH1	black	0.6 Nm
S331	X	X	N/A	M3 x 8 mm		Phillips PH2	Silver	0.6 Nm
S332	X	X	CA05973-8491 same as -S304 but color	M3 x 4 mm		countersink Phillips PH1	black	0.4 Nm
S333	X	X		M3 x 4.5 mm Ø7.5x42.5		Phillips PH2	Silver	0.6 Nm

screw reference number	WCZ	FIT	code number	type	photo	head tool / insert bit	color	Torque tolerance +-10%
S401	X	X	N/A	M4 x 6.5 mm		Phillips PH2	silver	0.6 Nm
S402	X	X	CA05973-9654	M4 x 5 mm		Phillips PH2	silver	0.8 Nm
S501	X	X	C26192-Y10-C209	REM 3 x 12 mm		special bit insert one-way head	black	0.6 Nm
S502	X	X	C26192-Y10-C176	REM 3 x 15 mm		special bit insert one-way head	black	0.6 Nm
S503	X	X	C26192-Y10-C174	Cross head EJOT PT 8 mm			silver	0.4 Nm
S504	X		C26192-Y10-C75	UNC 6-32 x 4.8 mm		hexagon head 5 mm / cross PZ2	black	0.6 Nm
		X	CP126822-01	UNC 6-32 x 4.8 mm		hexagon head 5 mm / cross PZ2	black	0.6 Nm
S505	X		C26192-Y10-C200	UNC 6-32 x 4 mm		Phillips PH1	silver	0.6 Nm
		X	CA32432-0164 or CA32432-0170	UNC 6-32 x 4 mm		Phillips PH1 / JIS 1012 type H1	silver	0.6 Nm
S506	X	X	C26192-Y10-C211	Knurled screw M3 x 4.5 mm		Phillips PH1	black	0.2 Nm
S507	X	X	A3C40218449	Knurled screw M3 x 15 mm		Phillips PH1	silver	0.2 Nm

screw reference number	WCZ	FIT	code number	type	photo	head tool / insert bit	color	Torque tolerance +-10%
S508	X	X	N/A	M5 x 11 mm		Phillips PH2	black	0.6 Nm
S509	X	X	A3C40237861	SCREW #6-32xL5.0 #2 NYLOK		Phillips PH2	silver	0.6~0.9 Nm
S601	X	X	EOL: V26827-B408-V989 V26827-B265-V5	UNC standoff 4-40 x 7.8 mm bolt: 4.9 mm total: 12.7 mm		hexagon screw driver 5 mm	silver	0.6 Nm
S602	X	X	C26192-Y1-C65	standoff M3 x 4.5 mm bolt: 5 mm total: 9.5 mm		hexagon screw driver 5 mm	silver	0.6 Nm
S603	X	X	C26192-Y1-C66	standoff M3 x 6 mm bolt: 8 mm total: 14 mm		hexagon screw driver 5 mm	silver	0.6 Nm
S604	X	X	C26192-Y1-C67	standoff M3 x 6 mm bolt: 12 mm total: 18 mm		hexagon screw driver 5 mm	silver	0.6 Nm
S605	X	X	C26361-B443-C210	standoff M3 x 3 mm bolt: 4.1 mm total: 7.1 mm		hexagon screw driver 5 mm	silver	0.6 Nm
S606	X	X	(for on board M.2 StandOffNut) C26361-B443-C210	standoff M3 x 3 mm bolt: 4.1 mm total: 7.1 mm		hexagon screw driver 5 mm	silver	0.3 Nm
S607	X	X	N/A	UNC standoff 4-40 x 6.5 mm		hexagon screw driver 5 mm	silver	0.2 Nm
S608	X	X	N/A	M3 x 33.6 mm + M4 x 6 mm		hexagon screw driver 7 mm	silver	1 Nm
S609	X	X	N/A	M3 x 37.9 mm + M4 x 7 mm		hexagon screw driver 7 mm	silver	1 Nm
S610	X	X	N/A	M3 x 5 mm		Phillips PH2	silver	0.8 Nm

screw reference number	WCZ	FIT	code number	type	photo	head tool / insert bit	color	Torque tolerance +-10%
S611	X	X	N/A	#2-32 x 12.6 mm		Phillips PH2	silver	0.2 Nm
S612	X	X	N/A	UNC standoff bolt: 5.0 mm 4-40 x 6.25 mm total: 11.25 mm		hexagon screw driver 5 mm	silver	0.6 Nm
S613	X	X	N/A	UNC standoff bolt: 4.8 mm 4-40 x 7.0 mm total: 11.8 mm		hexagon screw driver 5 mm	silver	0.6 Nm
(mechanic part in one chassis, provided by chassis vendor)	X	X	C26361-K1444-C11	M3 X 4.5 mm cheese head screw with spacer.		hexagon screw driver 5 mm / cross PZ2	silver	0.6 Nm
(screw is part of PDUAL AP200 kit)	X	X	C26361-Y10-C133	M2 x 3.5 mm		Flat head Phillips PH 0	silver	0.2 Nm

Denotation scheme

S1xx : Screws M1x

S2xx : Screws M2x

S3xx : Screws M3x

S4xx : Screws M4x

S5xx : Screws for special application

S6xx : Bolts

Document History:

Date	Item	Description
04. July 2017 05. July 2017	Name of a tool for fastening hexagon bolt	Old: "hexagon nut" New: "hexagon spanner head" hexagon screw driver
27. July 2017	S306 F6-SW2N3-06121	Changed part number of the screw
07. November 2018	Screw C26361-Y10-C133 added	Screw delivered with PDUAL AP200 kit
09. November 2018	Bolt C26361-B443-C210 Screw C26361-B443-C220	Bolt and screw for M.2 on board
09. January 2019	C26361-Y10-C133 Flat head	screw is part of PDUAL AP200 kit
19. February 2019	: A3C40218449	Kurled screw RAID controller

		and RX2530 M5
10. May 2021	Adding RX25x0/RX4770 M6 ODM screws	To creat some new S number screws
24. May 2021	Adding TX1330M5 ODM screws and change hexagon head tool to PH2	See yellow color update
02. June 2021	Adding CP100 screw S319 Torque 0.6 ~ 0.7 Nm	See yellow color update
07. June 2021	Update CP100 screw driver as PH2	See yellow color update
24. June 2021	Add RX1330M5 screws	See yellow color update
7. July 2021	Add TX1310M5 screws	See yellow color update
28. Dec 2021	Add RX1330M5 screws(S612/613) Add CX400M6/M7	See yellow color update See green color update
15. Jun. 2022	Correct S308/ S330 from PH2 to PH1 Add TX2550M7 screws (S332/S333) Add GX2550M7 screws (S402) Modify document title/ header line	See yellow color update