

Fujitsu Server PRIMERGY RX2540 M7

Operating Manual

Comments... Suggestions... Corrections...

The User Documentation Department would like to know your opinion of this manual. Your feedback helps us optimize our documentation to suit your individual needs.

Feel free to send us your comments by e-mail to manuals@fujitsu.com.

Documentation creation according to ISO 9001 and ISO 27001

To ensure high quality and information security standards while creating documentation, the quality management system and information security management system of Etteplan are certified in compliance with ISO 9001 and ISO 27001.

Etteplan Germany GmbH | www.etteplan.com

Copyright and Trademarks

Copyright 2024 Fujitsu Limited

All rights reserved.

Delivery subject to availability; right of technical modifications reserved.

All hardware and software names used are trademarks of their respective manufacturers.

- The contents of this manual may be revised without prior notice.
- Fujitsu assumes no liability for damages to third party copyrights or other rights arising from the use of any information in this manual.
- No part of this manual may be reproduced in any form without the prior written permission of Fujitsu.

Microsoft, Windows, Windows Server, and Hyper-V are trademarks or registered trademarks of Microsoft Corporation in the USA and other countries.

Intel and Xeon are trademarks or registered trademarks of Intel Corporation or its subsidiaries in the USA and other countries.

Before reading this manual

For your safety

This manual contains important information for safely and correctly using this product.

Carefully read the manual before using this product. Pay particular attention to the accompanying manual "Safety Notes and Regulations" and ensure that these safety notes are understood before using the product. Keep this manual and the "Safety Notes and Regulations" manual in a safe place for easy reference while using this product.

Radio interference

This product is a "Class A" ITE (Information Technology Equipment). In a domestic environment this product may cause radio interference, in which case the user may be required to take appropriate measures.

VCCI-A

Aluminum electrolytic capacitors

The aluminum electrolytic capacitors used in the printed circuit board assemblies of the product and in the mouse and keyboard are limited-life components. Use of these components beyond their operating life may result in electrolyte leakage or depletion, potentially causing emission of foul odor or smoke.

As a guideline, in a normal office environment (25 °C) operating life is not expected to be reached within the maintenance support period (5 years). However, operating life may be reached more quickly if, for example, the product is used in a hot environment. The customer shall bear the cost of replacing replaceable components which have exceeded their operating life. Note that these are only guidelines, and do not constitute a guarantee of trouble-free operation during the maintenance support period.

High safety use

This product has been designed and manufactured to be used in commercial and/or industrial areas as a server.

The product is not suitable for use at visual display workplaces according to §2 of the Workplace Regulations (applies to all server systems except TX server systems).

When used as visual display workplace, it must not be placed in the direct field of view to avoid incommoding reflections (applies only to TX server systems).

The device has not been designed or manufactured for uses which demand an extremely high level of safety and carry a direct and serious risk of life or body if such safety cannot be assured.

These uses include control of nuclear reactions in nuclear power plants, automatic airplane flight control, air traffic control, traffic control in mass transport systems, medical devices for life support, and missile guidance control in weapons systems (hereafter, "high safety use"). Customers should not use this product for high safety use unless measures are in place for ensuring the level of safety demanded of such use. Please consult the sales staff of Fujitsu if intending to use this product for high safety use.

Measures against momentary voltage drop

This product may be affected by a momentary voltage drop in the power supply caused by lightning. To prevent a momentary voltage drop, the use of an uninterruptible power supply is recommended.

(This notice follows the guidelines of Voltage Dip Immunity of Personal Computer issued by JEITA, the Japan Electronics and Information Technology Industries Association.)

Technology controlled by the Foreign Exchange and Foreign Trade Control Law of Japan

Documents produced by Fujitsu may contain technology controlled by the Foreign Exchange and Foreign Trade Control Law of Japan. Documents which contain such technology should not be exported from Japan or transferred to non-residents of Japan without first obtaining authorization in accordance with the above law.

Harmonic Current Standards

This product conforms to harmonic current standard JIS C 61000-3-2.

Only for Japan: About SATA HDDs

The SATA version of this server supports HDDs with SATA/BC-SATA storage interfaces. Please note that the usage and operation conditions differ depending on the type of HDD used.

For more information on the usage and operation conditions of each available type of HDD, see the following internet address:

<https://jp.fujitsu.com/platform/server/primergy/harddisk/>

Only for Japan:

Shielded LAN cables should be used in this product.

UK Importer information

Fujitsu Services Limited

22 Baker Street, London, W1U 3BW, United Kingdom

Version history

Issue number	Issue date	Description
V 1.0	01/2023	Initial release
V 1.1	03/2023	Initial release Optane PMem memory modules removed
V 2.0	05/2023	The following sections were added <ul style="list-style-type: none">• Liquid cooling• Power management features
V 3.0	08/2023	The following sections were updated <ul style="list-style-type: none">• Indicators on the Common Operation Panel (COP)• Dimension/Weight• Ambient conditions
V 4.0	01/2024	Following section was added: <ul style="list-style-type: none">• iRMC cannot read detailed information from the NVIDIA T400 card Following section was updated: <ul style="list-style-type: none">• Dimension/Weight
V 5.0	12/2024	Following sections were updated: <ul style="list-style-type: none">• List of documents• Customer Self Service (CSS)• Connectors on the server rear

Content

1	Introduction	13
1.1	Concept and target groups of this manual	13
1.2	Notational conventions	13
2	Before you start	15
2.1	Safety notes	15
2.2	Documentation overview	15
2.2.1	About availability of manuals	15
2.2.2	List of documents	16
3	Product description	19
3.1	Overview of the server	19
3.1.1	Server front	19
3.1.1.1	3.5-inch HDD configuration	19
3.1.1.2	2.5-inch HDD/SSD configuration	20
3.1.2	Server rear	21
3.1.2.1	Servers with air cooling	21
3.1.2.2	Servers with liquid cooling	23
3.2	Features	23
3.2.1	Customer Self Service (CSS)	23
3.2.2	System board	24
3.2.3	Trusted Platform Module (TPM)	24
3.2.4	Power supply unit (PSU)	25
3.2.5	Advanced Thermal Design (ATD)	26
3.2.6	Configuration Thermal Design (CTD)	26
3.2.7	High level of availability and data security	27
3.2.8	iRMC S6 with integrated management LAN connector	27
3.2.9	Infrastructure Manager	28

Content

3.2.10	Server management	29
3.2.11	ServerView Installation Manager	30
3.2.12	Service and support	30
3.2.13	ISM Remote Management	30
3.2.14	ServerView Remote Management	31
3.2.15	Property and data protection	31
3.2.16	BIOS setup security functions	32
3.3	Connectors, controls, and indicators	32
3.3.1	Server front	32
3.3.1.1	Connectors on the server front	32
3.3.1.2	Controls on the Common Operation Panel (COP)	33
3.3.1.3	Indicators on the server front	34
3.3.2	Server rear	41
3.3.2.1	Connectors on the server rear	41
3.3.2.2	ID, CSS and Global Error indicators	43
3.3.2.3	LAN indicators	45
3.3.2.4	Indicator on hot-plug PSU	47
4	Important information	49
4.1	Introduction	49
4.2	Safety instructions	49
4.2.1	Basic safety instructions	49
4.2.2	Before starting up	50
4.2.3	Installation and operation	50
4.2.4	Batteries	53
4.2.5	Working with optical disk drives (ODDs) and media	53
4.2.6	Laser information	55
4.2.7	Modules with Electrostatic-Sensitive Devices (ESD modules)	55
4.2.8	Transporting the server	57
4.2.9	Installing the server in the rack	58
4.2.10	Other important information	58
4.3	CE conformity	59
4.4	ENERGY STAR	59

4.5	FCC Class A Compliance Statement	60
4.6	Environmental protection	61
5	Starting up.....	63
<hr/>		
5.1	Safety notes.....	63
5.2	Installation steps, overview.....	63
5.3	Unpacking the server	65
5.4	Installing the server in the rack.....	66
5.4.1	Overview	66
5.4.2	Installing the server in the rack.....	67
5.4.3	Sliding the server into the rack.....	70
5.5	Connecting cables.....	71
5.5.1	Notes on connecting/disconnecting cables	71
5.5.2	Connecting devices to the server	72
5.5.3	Connecting the liquid cooling (LC) to the external cooling environment (special release).....	73
5.5.4	Connecting the power cord.....	74
5.5.4.1	Overview	74
5.5.4.2	Connecting the power cord (AC PSU).....	75
5.5.4.3	Connecting the power cord (DC PSU).....	78
5.6	Switching on the server for the first time	81
5.7	Installing the front cover with lock	82
5.8	Configuring the server with ServerView Installation Manager.....	82
5.9	Configuring the server without ServerView Installation Manager.....	84
5.10	Notes on configuring controllers.....	84
5.10.1	General Notes.....	84
5.10.2	Notes on onboard SATA controllers	85
5.10.3	Notes on SAS/SATA RAID controllers	85

Content

5.11	Note on operating system	85
6	Operation	87
6.1	Safety notes	87
6.2	Removing and installing the front cover with lock	87
6.3	Switching the server on and off	88
6.4	Installing HDD/SSD modules	91
6.4.1	Installing 3.5-inch HDD modules	91
6.4.2	Installing 2.5-inch HDD/SSD modules	93
6.5	Installing a second PSU	95
6.6	Cleaning the server	98
7	Troubleshooting and tips	99
7.1	General proceeding	99
7.2	iRMC cannot read detailed information from the NVIDIA T400 card	99
7.3	Power-on indicator remains unlit after you have switched on your device	100
7.4	System does not boot after installing a new HDD	100
7.5	Screen remains blank	101
7.6	No screen display or display drifts	101
7.7	Server switches itself off	102
7.8	No mouse pointer displayed on screen	102
7.9	No effect of keyboard or mouse	102

7.10	Time and/or date is incorrect.....	103
7.11	Temperature warning.....	103
7.12	Added drive reported as defective.....	104
7.13	Expansion cards or onboard devices not recognized.....	104
7.14	ODD cannot read data.....	105
8	Technical data.....	107

8.1	Data Sheets.....	107
8.2	System board.....	107
8.3	Processor (CPU).....	107
8.4	Memory modules configuration.....	108
8.5	Interfaces.....	108
8.6	Onboard or integrated controllers.....	110
8.7	Slots.....	110
8.8	Drive bays.....	112
8.9	Dimension/Weight.....	112
8.10	Ventilation clearance.....	113
8.11	Ambient conditions.....	113
8.12	Noise level.....	114
8.13	Electrical values of the AC PSUs.....	114
8.14	Electrical values of the DC PSU -48 V.....	119
8.15	Electrical values of the HVDC PSU 380 V.....	119
8.16	Electrical values of the system.....	120

Content

8.17 Compliance with standards122

9 Warranty and service125

1 Introduction

1.1 Concept and target groups of this manual



This operating manual describes how to install, set up and operate your server.

This operating manual is intended for those responsible for installing the hardware and ensuring that the system runs smoothly. The operating manual contains all the information you need to put the PRIMERGY RX2540 M7 into operation.

To understand the various expansion options, you will need to be familiar with the fields of hardware and data transmission and you will require a basic knowledge of the underlying operating system.

1.2 Notational conventions

The following notational conventions are used in this manual:

Text in bold	Indicates references to names of interface elements.
Text in monospace	Indicates commands.
"Quotation marks"	Indicate names of chapters and terms that are being emphasized.
▶	Describes activities that must be performed in the order shown.
 CAUTION	Pay particular attention to texts marked with this symbol. Failure to observe this warning may endanger your life, destroy the system or lead to the loss of data.
	Indicates additional information, notes, and tips.

2 Before you start

2.1 Safety notes



CAUTION

▶ Before you start to install, set up and operate your server, please carefully read the safety instructions in "Important information" on [page 49](#).

2.2 Documentation overview

2.2.1 About availability of manuals

To get an overview on all documents for your server, see [Table 1](#).



All documentation on PRIMERGY hardware and software is available online on the Fujitsu support page at:

<https://support.ts.fujitsu.com>

For Japan:

<https://www.fujitsu.com/jp/products/computing/servers/primergy/manual/>

For Japan:

The complete PRIMERGY documentation set can also be downloaded as a DVD ISO image at:

<https://www.fujitsu.com/jp/products/computing/servers/primergy/downloads/>

2.2.2 List of documents

Document	Description
"Safety Notes and Regulations" manual "安全上のご注意" for Japan	Important safety information, available online, or as a printed copy
"Fujitsu Server PRIMERGY RX2540 M7 Operating Manual"	Information how to install, set up and operate your server, available online
"Fujitsu Server PRIMERGY RX2540 M7 Upgrade and Maintenance Manual"	Instructions for upgrading the server configuration or replacing defective hardware, available online
"D3983 BIOS Setup Utility for Fujitsu Server PRIMERGY RX2540 M7 Reference Manual"	Information on configurable BIOS options and parameters, available online
"Fujitsu Server PRIMERGY RX2540 M7 Disassembly and Recycling Instructions"	Instructions for disassembling and recycling the server, available online
System foil	Label inside the top cover outlining connectors, indicators and jumper
iRMC S6 documentation	<ul style="list-style-type: none">– "iRMC S6 - Concepts and Interfaces" user guide– "iRMC S6 - Configuration and Maintenance" user guide– "iRMC S6 - Web Interface" user guide
Infrastructure Manager documentation	"Fujitsu Software Infrastructure Manager V2.9.0 Infrastructure Manager for PRIMEFLEX V2.9.0 User's Guide"
ServerView documentation	– "ServerView embedded Lifecycle Management (eLCM)" user guide

Document	Description
Illustrated Spares catalog	Spare parts identification and information system (not valid for Japan), available for online use or download (Windows OS) at https://manuals.ts.fujitsu.com/isc_illustrated_spares/ .
Glossary	Contains abbreviations and explanations, available online
"Warranty" manual "保証書" for Japan	Important information on warranty regulations, recycling and service, available online, or as a printed copy
"Returning used devices" manual	Recycling and contact information, available online at https://ts.fujitsu.com/recycling , or as a printed copy
"Service Desk" leaflet "サポート&サービス" for Japan	Not applicable in Japan and other countries that have different regulations for recycling
Additional documentation	RAID documentation, "Intel Virtual RAID on CPU (Intel VROC) User Guide" and "NVMe User Guide", available online at https://support.ts.fujitsu.com/ For Japan: https://www.fujitsu.com/jp/products/computing/servers/primergy/manual/
Third party documentation	<ul style="list-style-type: none"> – Operating system documentation, online help – Peripherals documentation

Table 1: List of documents

3 Product description

3.1 Overview of the server

3.1.1 Server front

3.1.1.1 3.5-inch HDD configuration

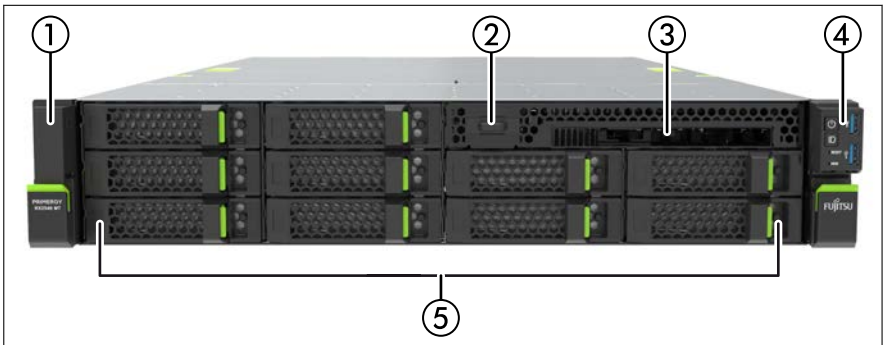

Figure 1: Front side 10x 3.5-inch HDDs/SSDs

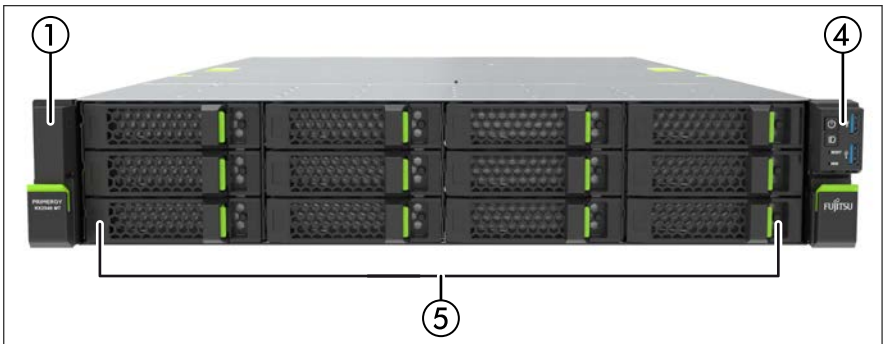

Figure 2: Front side 12x 3.5-inch HDDs/SSDs

- | | |
|------------------------------|--------------------------|
| 1 Thermal sensor | 4 Common Operation Panel |
| 2 Front VGA (option) | 5 HDDs / dummy modules |
| 3 ODD (option) / dummy cover | |

Product description

3.1.1.2 2.5-inch HDD/SSD configuration

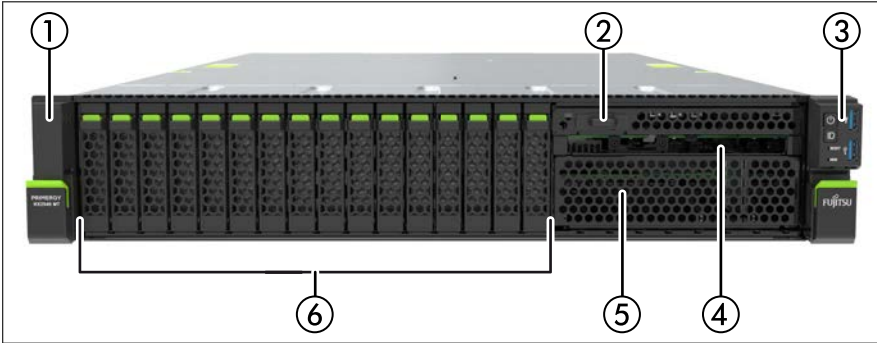

Figure 3: Front side 16x 2.5-inch HDDs / SSDs / PCIe SSDs

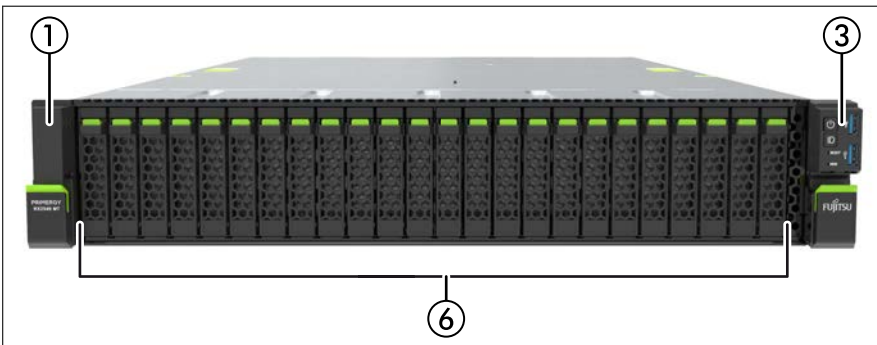

Figure 4: Front side 24x 2.5-inch HDDs / SSDs / PCIe SSDs

- | | | | |
|---|----------------------------|---|---|
| 1 | Thermal sensor | 5 | LTO drive (option) / RDX drive (option) / dummy cover |
| 2 | Front VGA (option) | 6 | HDDs / SSDs / PCIe SSDs / dummy modules |
| 3 | Common Operation Panel | | |
| 4 | ODD (option) / dummy cover | | |

3.1.2 Server rear

3.1.2.1 Servers with air cooling

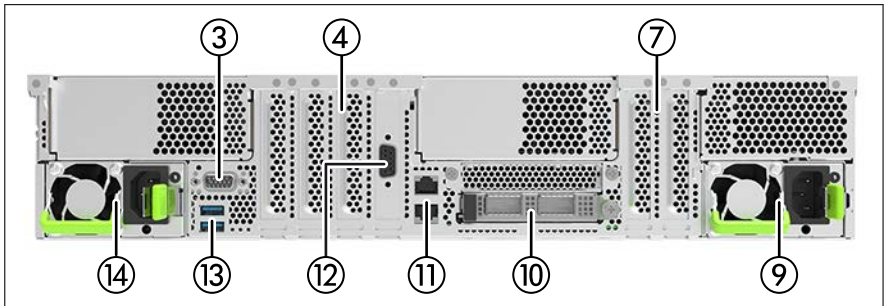

Figure 5: Server rear (standard configuration)

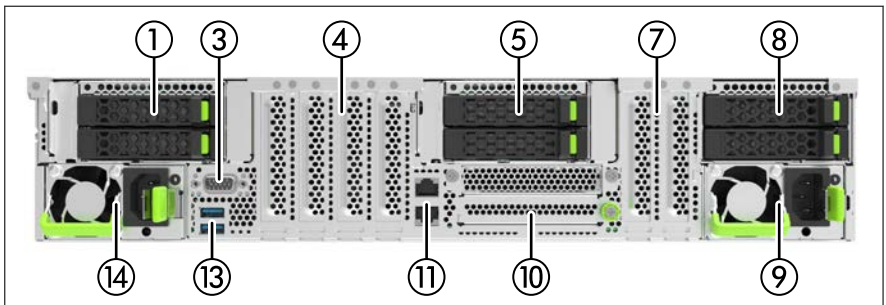

Figure 6: Server rear (configuration with rear HDD cages)

Product description

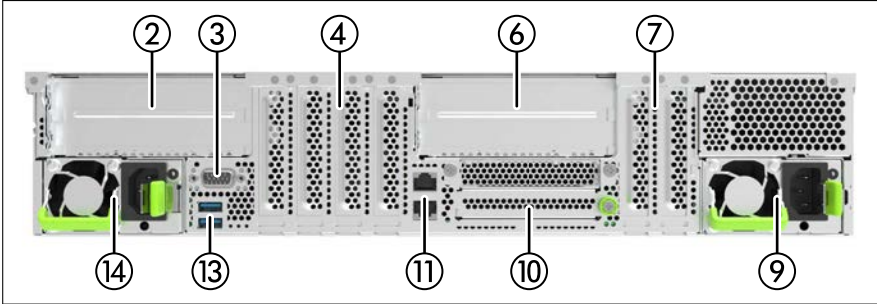

Figure 7: Server rear (configuration with riser modules)

- | | | | |
|---|--|----|-----------------------------------|
| 1 | HDDs / SSDs / PCIe SSDs | 7 | PCIe slots 1-2 |
| 2 | PCIe slots 9 or 9/10 / riser module 2 (option) | 8 | HDDs / SSDs / PCIe SSDs |
| 3 | Rear VGA | 9 | PSU 2 (option) / dummy cover |
| 4 | PCIe slots 5-8 | 10 | OCP module (option) / dummy cover |
| 5 | HDDs / SSDs / PCIe SSDs | 11 | Management LAN |
| 6 | PCIe slots 3 or 3/4 / riser module 1 (option) | 12 | Serial interface (option) |
| | | 13 | USB 3.0 (2x) |
| | | 14 | PSU 1 |

PCIe slots 9 and 10 (2) are available when riser module 2 is installed.

PCIe slots 3 and 4 (6) are available when riser module 1 is installed.

3.1.2.2 Servers with liquid cooling

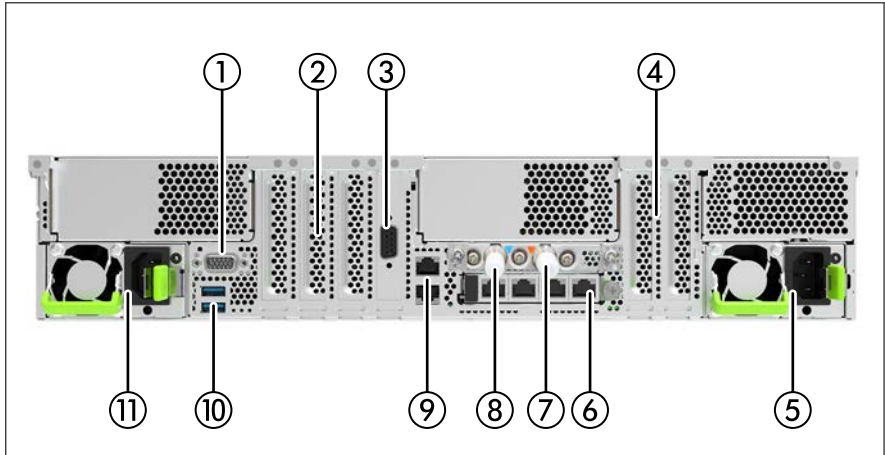

Figure 8: Server rear with liquid cooling

- | | | | |
|---|--|----|--|
| 1 | Rear VGA | 7 | Liquid cooling connector - liquid outlet |
| 2 | PCIe slots 5-8 | 8 | Liquid cooling connector - liquid inlet |
| 3 | Serial interface (option) / slot cover | 9 | Management LAN |
| 4 | PCIe slots 1-2 | 10 | USB 3.0 (2x) |
| 5 | PSU 2 (option) / dummy cover | 11 | PSU 1 |
| 6 | OCP module (option) / dummy cover | | |

3.2 Features

3.2.1 Customer Self Service (CSS)

The PRIMERGY Customer Self Service (CSS) concept enables you to identify and replace the affected component yourself in the case of certain error scenarios.

In the CSS concept, you can replace the following components yourself in the event of an error:

- Hot-plug HDD/SSD modules
- Hot-plug PCIe SSD modules

Product description

- Hot-plug PSUs
- Hot-plug fan modules
- Memory modules (not allowed for Japan)
- Expansion cards (not allowed for Japan)

For more information on replacing these components, see the "Fujitsu Server PRIMERGY RX2540 M7 Upgrade and Maintenance Manual".

CSS indicators on the front panel and I/O panel of the PRIMERGY server provide you with information if a CSS event arises.



For the latest information on optional products provided for the PRIMERGY RX2540 M7, see the configurator tool of the server:
https://ts.fujitsu.com/products/standard_servers/index.html

For Japan:

<https://www.fujitsu.com/jp/products/computing/servers/primergy/>

3.2.2 System board

The features of the system board are described in the "Fujitsu Server PRIMERGY RX2540 M7 Upgrade and Maintenance Manual". The setup possibilities are described in the "D3983 BIOS Setup Utility for Fujitsu Server PRIMERGY RX2540 M7 Reference Manual".

3.2.3 Trusted Platform Module (TPM)

A TPM for safer storage of keys can be implemented as an option. This module enables programs from third party manufacturers to store key information (e.g. drive encryption using Windows Bitlocker Drive Encryption).

The TPM is activated via the BIOS (for more information, see the "D3983 BIOS Setup Utility for Fujitsu Server PRIMERGY RX2540 M7 Reference Manual").

**CAUTION**

- ▶ When using the TPM, note the program descriptions provided by the third party manufacturers.
- ▶ You must create a backup of the TPM content. To do this, follow the third party manufacturer's instructions. Without this backup, if the TPM or the system board is faulty, you will not be able to access your data.
- ▶ If a failure occurs, please inform your service about the TPM activation before it takes any action, and be prepared to provide them with your backup copies of the TPM content.

3.2.4 Power supply unit (PSU)

The server can be equipped with:

- Up to two AC PSUs

In its basic configuration the server has one PSU that adjusts automatically to any mains voltage in the range of 100 V - 240 V (AC PSU Platinum) or 200 V - 240 V (AC PSU Titanium). Besides the PSU, a second PSU can be installed optionally to serve as a redundant power supply. If one PSU fails, the second PSU in the redundant configuration ensures operation can continue uninterrupted and the defective PSU can be replaced during operation (hot-plug). The second PSU can be installed during operation.

- Up to two DC PSUs

In its basic configuration the server has one PSU that adjusts automatically to any mains voltage in the range of -48 V - -60 V (DC PSU -48 V) or 200 V - 380 V (HVDC PSU 380 V). Besides the PSU, a second PSU can be installed optionally to serve as a redundant power supply. If one PSU fails, the second PSU in the redundant configuration ensures operation can continue uninterrupted and the defective PSU can be replaced during operation (hot-plug). The second PSU can be installed during operation.

- One AC PSU or DC PSU and one PSU dummy cover

3.2.5 Advanced Thermal Design (ATD)

The ATD option allows you to operate the system with a wider temperature range either of 5 °C to 40 °C or 5 °C to 45 °C, depending on your system and configuration.

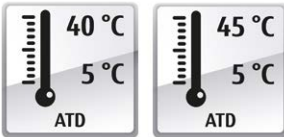

This option can only be ordered from the manufacturer and is indicated by the respective logo on the identification rating plate.



CAUTION

► In a system that is configured with ATD, only certain components which support the respectively increased higher operating temperature range may be installed and used. For applicable restrictions, see the official configurator tool.

3.2.6 Configuration Thermal Design (CTD)

The CTD option allows you to operate the system with a temperature range from 5 °C to 30 °C with corresponding configurations.



PRIMERGY servers are designed for the usage with operating temperatures of up to 35 °C. There could be configurations that are not able to work within this normal operation class. Please refer to Datasheet and Fujitsu WebArchitect (www.fujitsu.com/configurator/public) to obtain detailed information on the corresponding configurations.



This option can only be ordered from the manufacturer and is indicated by the respective logo on the identification rating plate.

**CAUTION**

▶ In a system that is configured with CTD, only certain components which support the respectively decreased lower operating temperature range may be installed and used. For applicable restrictions, see the official configurator tool.

3.2.7 High level of availability and data security

When memory data is accessed, 1-bit errors are identified in the main memory and automatically corrected with the Error Correcting Code (ECC) method.

Automatic Server Reconfiguration and Restart (ASR&R) restarts the system in the event of an error and automatically "hides" the defective system components.

The Prefailure Detection and Analysis (PDA) technology from Fujitsu analyzes and monitors all components that are critical for system reliability.

A RAID controller supports different RAID levels and increase the availability and data security of the system.

The HDD/SSD modules provide additional availability.

3.2.8 iRMC S6 with integrated management LAN connector

The iRMC S6 (integrated **R**emote **M**anagement **C**ontroller) is a Baseboard Management Controller (BMC) with integrated management LAN connector and expanded functionality. In this way, the iRMC S6 enables complete control of PRIMERGY servers, regardless of system status, and thus particularly the control of PRIMERGY servers that are in the "out-of-band" system status.

Major functions supported by the iRMC S6 include the following:

- Browser access via the own Web server of the iRMC S6
- Secure communication (SSH, SSL)
- Power Management for the managed server (depending on its system status)
- Power Consumption Management

Product description

- Connecting virtual drives as remote storage
- Text-based and graphic console bypass (Advanced Video Redirection)
- Remote Storage
- Command Line Interface (CLI)
- Simple, interactive or script-based iRMC S6 configuration
- Customer Self Service (CSS)
- User management of the iRMC S6
- Multi-computer, global iRMC S6 user administration using an LDAP Directory Service
- Automatic network configuration via DNS / DHCP
- Power supply of the iRMC S6 via the system standby supply
- Full-coverage alarm management
- System Event Log (SEL) reading and processing
- IPMI support
- CIM / WS-MAN support
- Internal Event Log for user login / logout auditing



More information about the iRMC S6 can be found in the iRMC S6 user guides, see "[List of documents](#)" on page 16.

3.2.9 Infrastructure Manager

Fujitsu is standardizing on Infrastructure Manager (ISM) as its powerful tool for managing and monitoring entire IT landscapes, including servers, storage, networking as well as power and cooling.

ISM simplifies data center management by centralizing all operations and monitoring the entire IT infrastructure environment in a single unified platform. Using one user interface, ISM is not just restricted to managing a single data center, but is also capable of distributed data center management.

Flexible licensing options are available to suit different business requirements.

– ISM Essential license

Provides a quick start to efficient infrastructure management with converged monitoring and management capabilities free-of-charge.

– ISM Advanced license

Fully featured advanced version of ISM that provides comprehensive infrastructure management across multiple data center.



More information about ISM is available from the Fujitsu web pages:
<https://www.fujitsu.com/emeia/products/computing/servers/infrastructure-management/index.html>

3.2.10 Server management

Server management is implemented using the Infrastructure Manager which enables the management of all PRIMERGY servers in the network via a central console.

The Infrastructure Manager supports the following functions:

- Manages device information such as model names, serial numbers, and IP addresses
- Monitoring values for Air Inlet Temperature, CPU Usage, and Power Consumption
- Creates, stores, and assigns profiles which are the setting information for the managed nodes
- Operates log collection of various kinds of logs (Hardware logs, Operating System logs, and ServerView Suite logs) for multiple managed nodes together and executes integrated management of collected logs
- Firmware updates for multiple managed nodes together and manages versions of the firmware in an integrated manner
- Network management the status of physical connection between managed nodes and the status of virtual connection between virtual machines, virtual switches, and virtual routers

More information on the Infrastructure Manager is provided in the associated documentation.

3.2.11 ServerView Installation Manager

You can configure the PRIMERGY server quickly and precisely with the ServerView Installation Manager software provided. User-guided menus are available for installing the server operating system (for more information, see ["Notes on configuring controllers" on page 84](#)).

3.2.12 Service and support

PRIMERGY servers are easy to maintain and modular, thus enables quick and simple maintenance.

The handles and locks (touch points) used to exchange components are colored green to ensure simple and immediate recognition.

In order to prevent the components from being damaged by incorrect handling when they are being installed and removed, the areas of all components that can be touched without damaging them are also marked green.

PRIMERGY diagnostic LEDs fitted on the system board indicate which component (memory module, CPU, fan, or expansion card) is not functioning properly.

The Flash EPROM program supplied with the Fujitsu utilities supports a fast BIOS update.

With the iRMC on the system board, the server can also be maintained and serviced remotely. This enables remote diagnosis for system analysis, remote configuration and remote restart should the operating system or hardware fail.

3.2.13 ISM Remote Management

ISM Remote Management is the remote management solution from Fujitsu for PRIMERGY servers. ISM Remote Management and the relevant hardware components integrated on the system board allow remote monitoring and maintenance as well as fast restoration of operation in the event of errors.

Remote monitoring and maintenance avoids time-consuming and costly on-site repairs and reduces service costs. This leads to a reduction in the total cost of ownership and an excellent return on investment for the remote management solution.

The administrator can access all system information and information from the sensors such as fan speeds or voltages via the BMC web interface. You can also start the text-based or graphic console bypass (Advanced Video Redirection, AVR) and connect virtual drives as remote storage.

3.2.14 ServerView Remote Management

ServerView Remote Management is the remote management solution from Fujitsu for PRIMERGY servers. ServerView Remote Management and the relevant hardware components integrated on the system board allow remote monitoring and maintenance as well as fast restoration of operation in the event of errors.

Remote monitoring and maintenance avoids time-consuming and costly on-site repairs and reduces service costs. This leads to a reduction in the total cost of ownership and an excellent return on investment for the remote management solution.

The administrator can access all system information and information from the sensors such as fan speeds or voltages via the iRMC web interface. You can also start the text-based or graphic console bypass (Advanced Video Redirection, AVR) and connect virtual drives as remote storage.



More information about the iRMC can be found in the iRMC user guides at <https://support.ts.fujitsu.com/>.

3.2.15 Property and data protection

The rack model is protected against unauthorized access by a lockable rack door.

3.2.16 BIOS setup security functions

The **Security** menu in BIOS Setup offers various options for protecting your data from unauthorized access. By combining these options, you can also achieve optimum protection for your system.

i A detailed description of the **Security** menu and how to assign passwords can be found in the "D3983 BIOS Setup Utility for Fujitsu Server PRIMERGY RX2540 M7 Reference Manual".

3.3 Connectors, controls, and indicators

3.3.1 Server front

3.3.1.1 Connectors on the server front

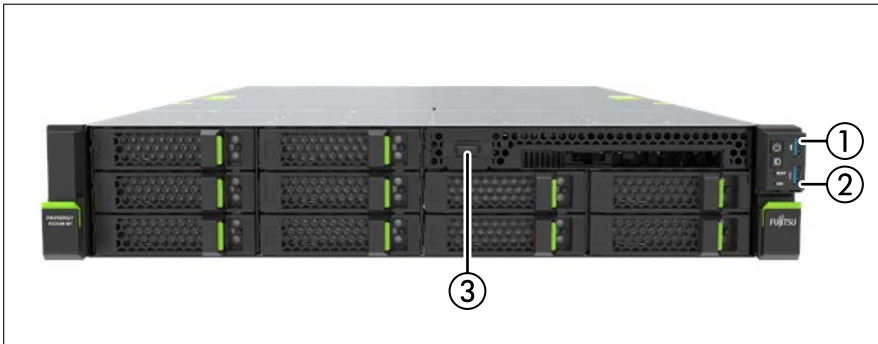

Figure 9: Connectors on the server front

- | | | | |
|---|-------------------|---|------------------------------|
| 1 | USB 3.0 connector | 3 | Front VGA connector (option) |
| 2 | USB 3.0 connector | | |

3.3.1.2 Controls on the Common Operation Panel (COP)

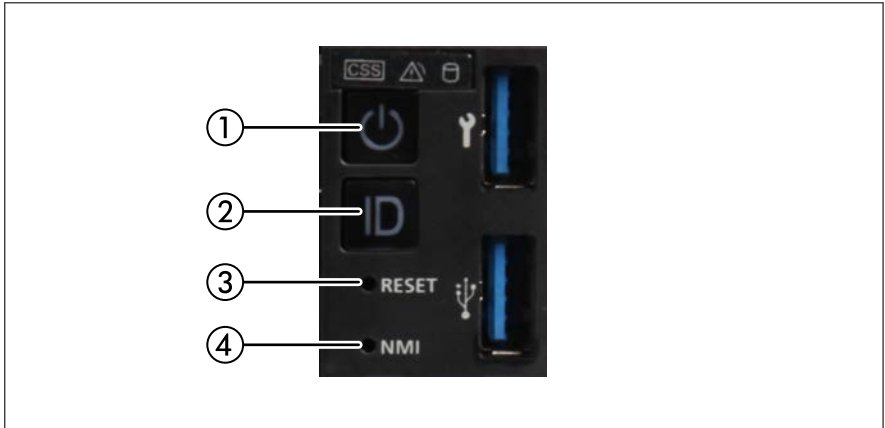

Figure 10: Controls on the COP

- | | | | |
|---|---------------|---|--------------|
| 1 | On/Off button | 3 | Reset button |
| 2 | ID button | 4 | NMI button |

On/Off button (1)

Used to switch the server on or off.



If the system is running an ACPI-compliant operating system, pressing the On/Off button will perform a graceful shutdown.

ID button (2)

Highlights the ID indicator on the front panel and I/O panel for easy server identification.

Reset button (3)

Reboots the system. Press the reset button with a straightened end of a paper clip.



CAUTION

Risk of data loss

Product description

NMI button (4)

Used to troubleshoot software and device driver errors. Press the NMI button with a straightened end of a paper clip.



CAUTION

▶ Use this button only if directed to do so by qualified certified maintenance personnel.

3.3.1.3 Indicators on the server front

Indicators on the Common Operation Panel (COP)

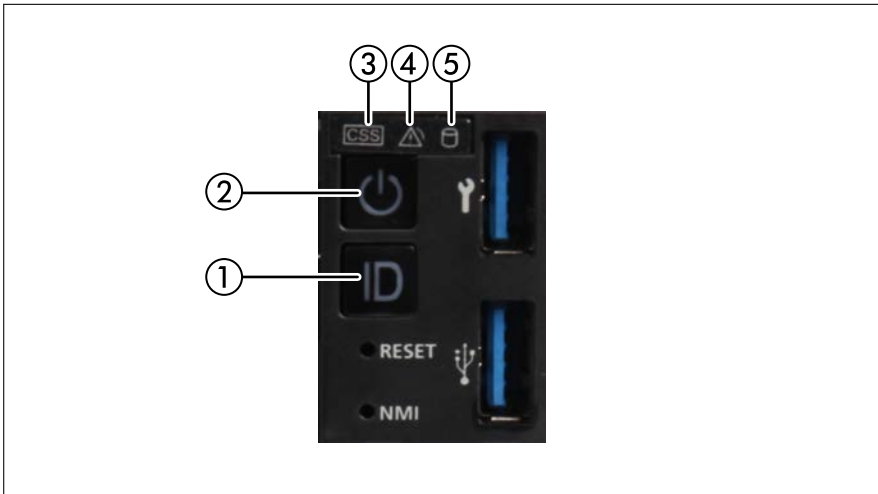

Figure 11: Indicators on the COP

- | | | | |
|---|---|---|----------------------------|
| 1 | ID indicator | 3 | CSS indicator |
| 2 | Power-on indicator / AC connected indicator | 4 | Global Error indicator |
| | | 5 | HDD/SSD activity indicator |

ID indicator (1)

See also "[iRMC-related status signals](#)" on page 37.

Status	Description
blue on	The server has been highlighted using the iRMC S6 web interface or the ID button on the front panel for easy identification.
flashing blue	The server has been highlighted for easy identification using the iRMC S6 with disabled local VGA output.

Power-on indicator / AC connected indicator (2)

Status	Description
off	The server is switched off and not connected to the mains.
green on	The server is switched on.
flashing white	The iRMC firmware is starting up after the server has been connected to the mains.
white on	<p>The server is switched off and connected to the mains (standby mode).</p>  After connecting the server to the mains, it will take about 60 seconds until the server will enter standby mode and can be switched on.
exchange flashing green and white	The server has been switched on but Power Cycle Delay settings delay it from turning on for a specified time.

CSS indicator (3)

Status	Description
off	No critical event detected (CSS component).
orange on	<p>Prefailure event detected (CSS component).</p> <p>For HDDs, see also "HDD prefailure detection" on page 37.</p>

Product description

Status	Description
flashing orange	CSS component failure detected.

Global Error indicator (4)

See also ["iRMC-related status signals" on page 37](#).

Status	Description
off	No critical event detected (non-CSS component).
orange on	Prefailure event detected (non-CSS component).
flashing orange	Non-CSS component failure detected. Possible causes: <ul style="list-style-type: none">– System is out of the specified temperature range– Defective sensor– CPU error– Error detected by server management software

HDD/SSD activity indicator (5)

Status	Description
flashing green	Data access in progress.



There are cases in which the HDD/SSD activity indicator does not flash green during data access depending on disk connection configuration. For example, if a PCIe SSD is not connected to a RAID controller, the HDD/SSD activity indicator does not flash green. Data access can be recognized at ["Access Indicator \(1\)" on page 40](#).



In case of M.2 SSD (NVMe connection) is installed.

- Green on, when M.2 SSD (NVMe connection) is idle.
- Flashing green, when M.2 SSD (NVMe connection) is data access in progress.
- Green on, when M.2 SSD (NVMe connection) is idle and other disk is data access in progress.

iRMC-related status signals

ID indicator	Global error indicator	Description
flashing blue	off	A remote connection has been established. Local VGA output has been disabled during the remote session.
flashing blue	flashing orange	An emergency flash of the iRMC firmware is in progress.



For more information about the iRMC flash procedure, see "Basic software procedures" in the "Fujitsu Server PRIMERGY RX2540 M7 Upgrade and Maintenance Manual".

HDD prefailure detection

Depending on your hardware configuration HDD prefailure detection will be supported.

The requirements are:

- iRMC S6 Firmware
- supported OOB RAID system

Indicator on the ODD



ODDs may have an indicator or not.

Product description

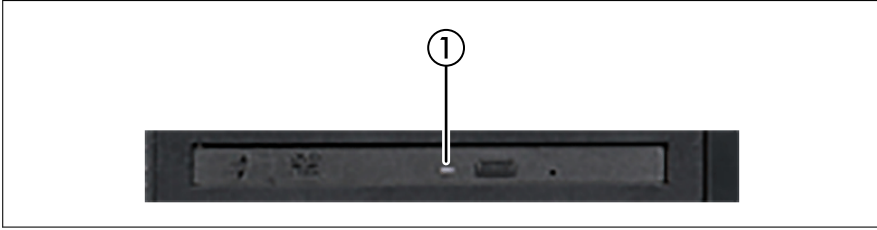

Figure 12: Indicator on the ODD (example)

- 1 Activity indicator

Activity indicator (1)

Status	Description
off	The ODD is inactive.
green on	The storage medium is being accessed.

Indicators on the RDX drive



Figure 13: Indicators on the RDX drive

- 1 RDX drive Power-on indicator

RDX drive Power-on indicator (1)

Status	Description
off	The drive is not powered on.
green on	The drive is ready and working properly.
green flashing	The drive is ejecting media.
amber on	RDX has detected a drive failure condition. For more information, run a diagnostics application.
green on / amber flashing once eject button is pressed	Host computer is accessing the media and the user has pressed the eject button. The drive will eject the media after host access is complete.

Indicators on the LTO drive



Figure 14: Indicators on the LTO drive

- 1 LTO drive Power-on indicator

LTO drive Power-on indicator (1)

Status	Description
off	The drive is not powered on.
green on	The drive is ready and working properly.
green flashing	The drive is ejecting media.
amber on	LTO has detected a drive failure condition. For more information, run a diagnostics application.

Product description

Status	Description
green on / amber flashing once eject button is pressed	Host computer is accessing the media and the user has pressed the eject button. The drive will eject the media after host access is complete.

Indicators on hot-plug HDD / SSD / PCIe SSD modules

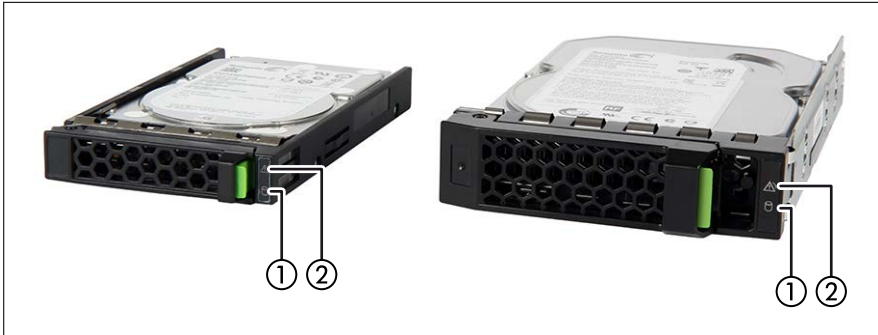

Figure 15: Indicators on an hot-plug HDD / SSD / PCIe SSD module

1 Access indicator

2 Error indicator

Access Indicator (1)

Status	Description
off	The HDD/SSD is inactive.
green on	The HDD/SSD being accessed.
continuous green flashing	The PCIe SSD has been detected.

Error indicator (2)

Status	Description
off	No HDD/SSD error detected.
orange on	An HDD/SSD error has been detected. Possible causes: <ul style="list-style-type: none"> – The drive is defective and needs replacing. – A RAID rebuild process has failed. – The HDD/SSD module has not been inserted correctly.
flashing orange slowly	HDD/SSD RAID rebuild is in progress. Data is being restored after replacing a drive that has been combined into a RAID array.

3.3.2 Server rear

3.3.2.1 Connectors on the server rear

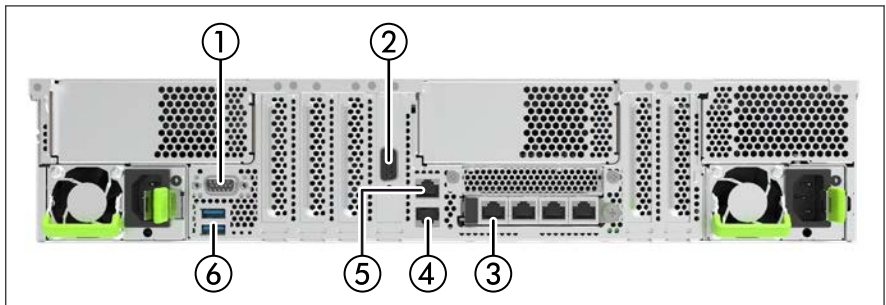

Figure 16: Connectors on the server rear

- | | | | |
|---|---------------------------|---|----------------------------|
| 1 | Rear VGA connector | 4 | Management LAN connector |
| 2 | Serial interface (option) | 5 | LAN connector (shared LAN) |
| 3 | OCP module (option) | 6 | USB 3.0 connectors (2x) |



The serial interface (2) can be used as the standard interface or for communication with iRMC. The serial interface connector is an option.

Product description

- i** Depending on the BIOS settings, the shared LAN connector may also be used as a management LAN connector. For more information, see the corresponding BIOS Setup Utility reference manual.
- i** Some of the devices connected require special software (e.g. drivers) (see documentation for the connected device).
- i** If an OCP module is installed, fan 1 will permanently be turned on in standby mode of the server.

Liquid cooling configuration

- i** A LC configuration is provided on special release request only.

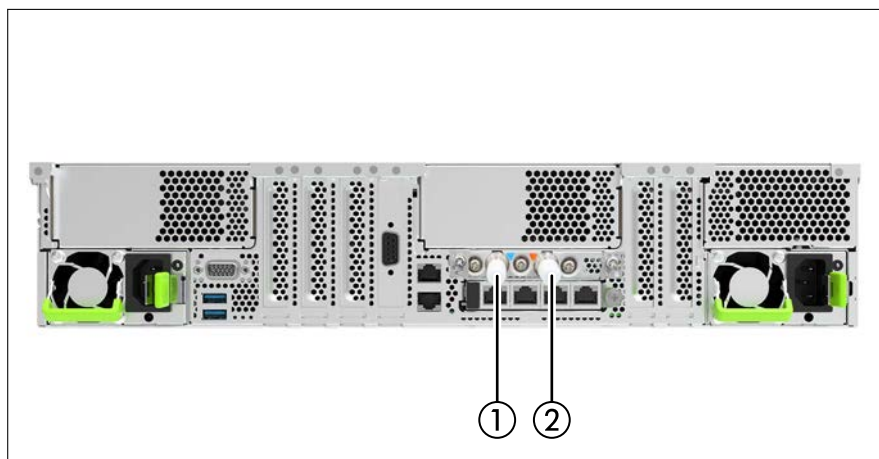

Figure 17: Quick connectors for liquid cooling

- | | |
|---|---|
| 1 Quick connector with red marking:
water outlet | 2 Quick connector with blue marking:
water inlet |
|---|---|

3.3.2.2 ID, CSS and Global Error indicators

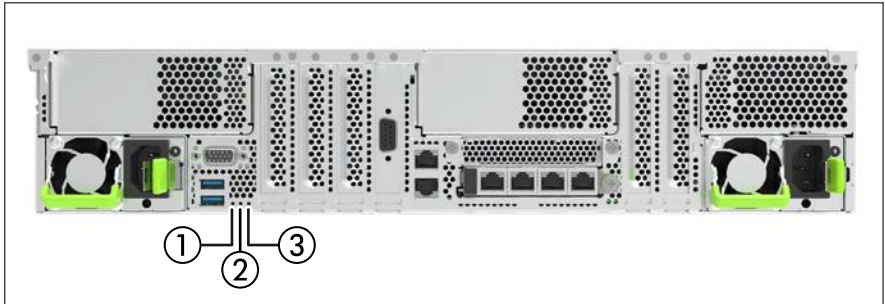

Figure 18: ID, CSS and Global Error indicators

- | | | | |
|---|------------------------|---|---------------|
| 1 | ID indicator | 3 | CSS indicator |
| 2 | Global Error indicator | | |

ID indicator (1)

See also ["iRMC-related status signals" on page 44](#).

Status	Description
blue on	The server has been highlighted using iRMC web interface or the ID button on the front panel for easy identification.
flashing blue	The server has been highlighted for easy identification using the iRMC (AVR) with disabled local VGA output.

Global Error indicator (2)

See also ["iRMC-related status signals" on page 44](#).

Status	Description
off	No critical event detected (non-CSS component).
orange on	Prefailure event detected (non-CSS component).

Product description

Status	Description
flashing orange	Non-CSS component failure detected. Possible causes: <ul style="list-style-type: none">– System is out of the specified temperature range– Defective sensor– CPU error– Error detected by server management software

CSS indicator (3)

Status	Description
off	No critical event detected (CSS component).
orange on	Prefailure event detected (CSS component).
flashing orange	CSS component failure detected.



Note on CSS and Global Error indicators on the COP:

If CSS and Global Error indicators are located in the same place on the COP of the server, also check the indicators on the front panel to determine if a CSS or Global Error event has been detected.



For more information on detected errors, see the System Event Log or use the iRMC web interface.

iRMC-related status signals

ID indicator	Global error indicator	Description
flashing blue	off	A remote connection has been established. Local VGA output has been disabled during the remote session.
flashing blue	flashing orange	An emergency flash of the iRMC firmware is in progress.

i For more information about the iRMC flash procedure, see "Basic software procedures" in the "Fujitsu Server PRIMERGY RX2540 M7 Upgrade and Maintenance Manual".

3.3.2.3 LAN indicators

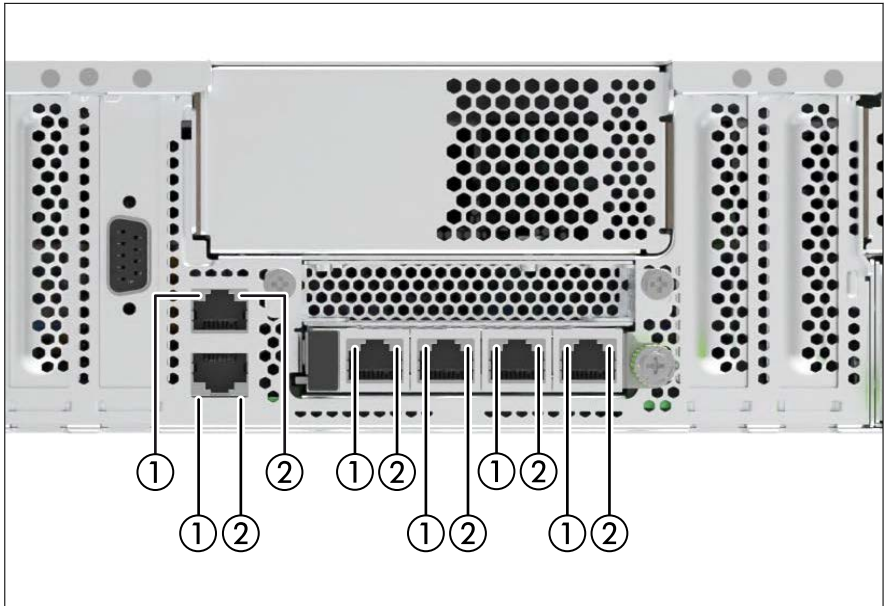

Figure 19: LAN indicators

- 1 LAN link/transfer indicator
- 2 LAN speed indicator

LAN link/transfer indicator (1)

Status	Description
green on	A LAN connection has been established.
off	LAN is not connected.
flashing green	LAN data transfer is in progress.

Product description

LAN speed indicator (2)

Status	Description
yellow on	Data traffic at a transfer rate of 1 Gbit/s.
green on	Data traffic at a transfer rate of 100 Mbit/s.
off	Data traffic at a transfer rate of 10 Mbit/s.

Indication of LAN connection supporting Energy Efficient Ethernet (EEE mode)

To configure the EEE mode, it is necessary that an add-in LAN card supports this mode and the connected switch supports this mode as well.

LAN link/transfer indicator (1)

Status	Description
short flashing green 3x, then off	A LAN connection has been established (1 Gbit or 100 Mbit) and EEE mode is active.

Table 2: LAN indicators if EEE mode is active

LAN speed indicator (2)

Status	Description
short flashing yellow 1x, then 2 seconds off green off	Data traffic at a transfer rate of 1 Gbit/s.
short flashing green 1x, then 2 seconds off yellow off	Data traffic at a transfer rate of 100 Mbit/s.

Table 3: LAN indicators if EEE mode is active

3.3.2.4 Indicator on hot-plug PSU



Figure 20: PSU status indicator (AC PSU)

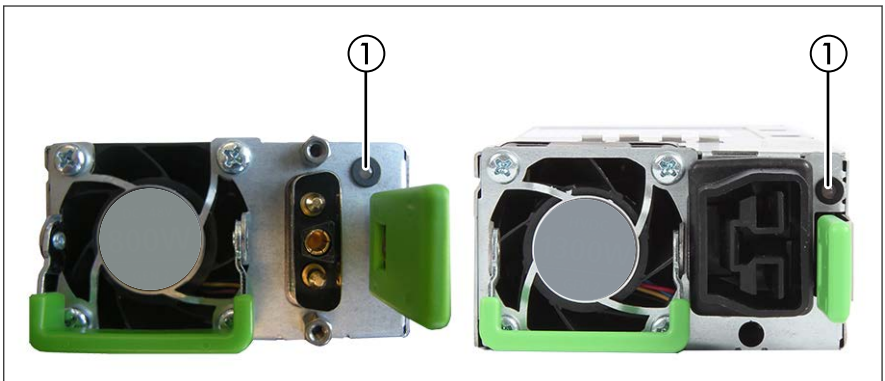

Figure 21: PSU status indicator (DC PSU)

1 PSU status indicator

PSU status indicator (1)

Status	Description
flashing green	The server is switched off, but mains voltage is present (standby mode).
green on	The server is switched on and operating properly.

Product description

Status	Description
flashing orange	An overload has been detected. The PSU is still running, but failure might be imminent.
orange on	A PSU failure has been detected.

4 Important information

4.1 Introduction

In this chapter you will find essential information regarding safety when working on your server.



Depending on your server or the installed options some information is not valid for your server.



CAUTION

▶ Before installing and starting up a server, please observe the safety instructions listed in the following section. This will help you to avoid making serious errors that could impair your health, damage the server and endanger the data base.

4.2 Safety instructions

4.2.1 Basic safety instructions



The following safety instructions are also provided in the manual "Safety Notes and Regulations" or "安全上のご注意".

This server meets the relevant safety regulations for IT equipment. If you have any questions about whether you can install the server in the intended environment, please contact your sales outlet or our customer service team.

- ▶ The actions described in this manual shall be performed by technical specialists. A technical specialist is a person who is trained to install the server including hardware and software.
- ▶ Repairs to the server that do not relate to CSS failures shall be performed by service personnel. Please note that unauthorized interference with the server will void the warranty and exempt the manufacturer from all liability.
- ▶ Any failure to observe the guidelines in this manual, and any improper repairs could expose the user to risks (electric shock, energy hazards, fire hazards) or damage the equipment.

- ▶ Only valid for non hot-plug components

Before installing/removing internal components to/from the server, turn off the server, all peripheral devices, and any other connected devices. Also unplug all power cords from the power outlet. Failure to do so can cause electric shock or damage.

4.2.2 Before starting up

- ▶ During installation and before operating the server, observe the instructions on environmental conditions for your server.

- ▶ If the server is brought in from a cold environment, condensation may form both inside and on the outside of the server.

Wait until the server has acclimatized to room temperature and is absolutely dry before starting it up. Material damage may be caused to the server if this requirement is not observed.

- ▶ Only transport the server in its original packaging or in packaging that protects it from impacts and jolts.

In Japan and APAC, transporting the server in its original packaging does not apply.

4.2.3 Installation and operation

- ▶ This server should not be operated in ambient temperatures above 35 °C. For servers with Advanced Thermal Design the ambient temperature can increase to 40 °C or 45 °C.

- ▶ If the server is integrated into an installation that draws power from an industrial power supply network with an IEC309 connector, the power supply's fuse protection must comply with the requirements for non-industrial power supply networks for type A connectors.

- ▶ The server automatically adjusts itself to a mains voltage, see the type label of your server. Ensure that the local mains voltage lies within these limits.

- ▶ This server must only be connected to properly grounded power outlets or connected to the grounded rack internal power distribution server with tested and approved power cords.

- ▶ If a DC power cord is used, the server must be connected to a proper DC source and earth ground stud/end.
- ▶ Ensure that the server is connected to a properly grounded power outlet close to the server.
- ▶ Ensure that the power sockets on the server and the properly grounded power outlets are easily accessible.
- ▶ The On/Off button or the main power switch (if present) does not isolate the server from the mains power supply. In case of repair or servicing disconnect the server completely from the mains power supply, unplug all power plugs from the properly grounded power outlets.
- ▶ Always connect the server and the attached peripheral devices to the same power circuit. Otherwise you run the risk of losing data if, for example, the server is still running but a peripheral device (e.g. memory subsystem) fails during a power outage.
- ▶ The adequately shielded data cables must be used.

All data and signal cables must have sufficient shielding. The use of cable type S/FTP Cat5 or higher is recommended. Use of unshielded or badly shielded cables may lead to increased emission of interference and/or reduced fault-tolerance of the device.
- ▶ Ethernet cabling has to comply with EN 50173 and EN 50174-1/2 standards or ISO/IEC 11801 standard respectively. The minimum requirement is a Category 5 shielded cable for 10/100 Ethernet, or a Category 5e cable for Gigabit Ethernet.
- ▶ Route the cables in such a way that they do not create a potential hazard (ensure that no-one can trip over them) and that they cannot be damaged. When connecting the server, see the relevant instructions in this manual.
- ▶ Never connect or disconnect data transmission lines during a storm (risk of lightning hazard).
- ▶ Ensure that no objects (e.g. jewelry, paperclips etc.) or liquids can get inside the server (risk of electric shock, short circuit).
- ▶ In emergencies (e.g. damaged casing, controls or cables, penetration of liquids or foreign bodies), contact the server administrator or your customer service team. Only disconnect the server from the mains power supply if there is no risk of harming yourself.

Important information

- ▶ Proper operation of the server (in accordance with IEC 60950-1/62368-1 resp. EN 60950-1/62368-1) is only ensured if the server is completely assembled and the rear covers for the installation slots have been fitted (electric shock, cooling, fire protection, interference suppression).
- ▶ Only install server expansions that satisfy the requirements and rules governing safety and electromagnetic compatibility and those relating to telecommunication terminals. If you install other expansions, they may damage the server or violate the safety regulations. Information on which server expansions are approved for installation can be obtained from our customer service center or your sales outlet.
- ▶ The components marked with a warning notice (e.g. lightning symbol) may only be opened, removed or exchanged by authorized, qualified personnel. Exception: CSS components can be replaced.
- ▶ The warranty is void if the server is damaged during installation or replacement of server expansions.
- ▶ Only set screen resolutions and refresh rates that are specified in the operating manual for the monitor. Otherwise, you may damage your monitor. If you are in any doubt, contact your sales outlet or customer service center.
- ▶ Only valid for non hot-plug components
Before installing/removing internal components to/from the server, turn off the server, all peripheral devices, and any other connected devices. Also unplug all power cords from the power outlet. Failure to do so can cause electric shock or damage.
Internal devices remain hot after shutdown. Wait for a while after shutdown before installing or removing internal options.
- ▶ Do not damage or modify internal cables or internal devices. Doing so may cause a server failure, fire, or electric shock and will void the warranty and exempt the manufacturer from all liability.
- ▶ The circuit boards and soldered parts of internal options are exposed and can be damaged by static electricity. To ensure reliable protection, you must wear an earthing band on your wrist when working with this type of module and connect it to an unpainted, conducting metal part of the server.
- ▶ Do not touch the circuitry on boards or soldered parts. Hold the metallic areas or the edges of the circuit boards.

- ▶ Install the screw removed during installation/detaching internal options in former position. To use a screw of the different kind can cause a breakdown of equipment.
- ▶ The procedure of installation on this notes might change depending on a configuration of option.

4.2.4 Batteries

- ▶ Incorrect replacement of batteries may lead to a risk of explosion. The batteries may only be replaced with identical batteries or with a type recommended by the manufacturer.
- ▶ Do not throw batteries into the trash can.
Batteries must be disposed of in accordance with local regulations concerning special waste.
- ▶ Ensure that you insert the battery the right way round.
- ▶ The battery used in this server may present a fire or chemical burn hazard if mistreated. Do not disassemble, heat about 100 °C (212F), or incinerate the battery.
- ▶ Replace the lithium battery on the system board in accordance with the instructions in the corresponding Upgrade and Maintenance Manual, chapter "System board and components" > "CMOS battery".
- ▶ All batteries containing pollutants are marked with a symbol (a crossed-out garbage can). In addition, the marking is provided with the chemical symbol of the heavy metal decisive for the classification as a pollutant:
Cd Cadmium
Hg Mercury
Pb Lead

4.2.5 Working with optical disk drives (ODDs) and media

When working with ODDs, these instructions must be followed.



CAUTION

- ▶ Only use CDs/DVDs/BDs that are in perfect condition, in order to prevent data loss, equipment damage and injury.
- ▶ Check each CD/DVD/BD for damage, cracks, breakages etc. before inserting it in the drive.

Note that any additional labels applied may change the mechanical properties of a CD/DVD/BD and cause imbalance and vibrations.

Damaged and imbalanced CDs/DVDs/BDs can break at high drive speeds (data loss).

Under certain circumstances, sharp CD/DVD/BD fragments can pierce the cover of the ODD (equipment damage) and can fly out of the drive (danger of injury, particularly to uncovered body parts such as the face or neck).

- ▶ High humidity and airborne dust levels are to be avoided. Electric shocks and/or server failures may be caused by liquids such as water, or metallic items, such as paper clips, entering a drive.
- ▶ Shocks and vibrations are also to be avoided.
- ▶ Do not insert any objects other than the specified CDs/DVDs/BDs.
- ▶ Do not pull on, press hard, or otherwise handle the CD/DVD/BD tray roughly.
- ▶ Do not disassemble the ODD.
- ▶ Before use, clean the ODD tray using a soft, dry cloth.
- ▶ As a precaution, remove disks from the ODD when the drive is not to be used for a long time. Keep the ODD tray closed to prevent foreign matter, such as dust, from entering the ODD.
- ▶ Hold CDs/DVDs/BDs by their edges to avoid contact with the disk surface.
- ▶ Do not contaminate the CD/DVD/BD surface with fingerprints, oil, dust, etc. If dirty, clean with a soft, dry cloth, wiping from the center to the edge. Do not use benzene, thinners, water, record sprays, antistatic agents, or silicone-impregnated cloth.
- ▶ Be careful not to damage the CD/DVD/BD surface.
- ▶ Keep the CDs/DVDs/BDs away from heat sources.

- ▶ Do not bend or place heavy objects on CDs/DVDs/BDs.
- ▶ Do not write with ballpoint pen or pencil on the label (printed) side.
- ▶ Do not attach stickers or similar to the label side. Doing so may cause rotational eccentricity and abnormal vibrations.
- ▶ When a CD/DVD/BD is moved from a cold place to a warm place, moisture condensation on the CD/DVD/BD surface can cause data read errors. In this case, wipe the CD/DVD/BD with a soft, dry cloth then let it air dry. Do not dry the CD/DVD/BD using devices such as a hair dryer.
- ▶ To avoid dust, damage, and deformation, keep the CD/DVD/BD in its case whenever it is not in use.
- ▶ Do not store CDs/DVDs/BDs at high temperatures. Areas exposed to prolonged direct sunlight or near heating appliances are to be avoided.



You can prevent damage from the ODD and the CDs/DVDs/BDs, as well as premature wear of the disks, by observing the following suggestions:

- Only insert disks in the drive when needed and remove them after use.
- Store the disks in suitable sleeves.
- Protect the disks from exposure to heat and direct sunlight.

4.2.6 Laser information

The ODD complies with IEC 60825-1 laser class 1.



CAUTION

The ODD contains a light-emitting diode (LED), which under certain circumstances produces a laser beam stronger than laser class 1. Looking directly at this beam is dangerous.

- ▶ Never remove parts of the ODD casing!

4.2.7 Modules with Electrostatic-Sensitive Devices (ESD modules)

ESD modules are identified by the following sticker:

Important information

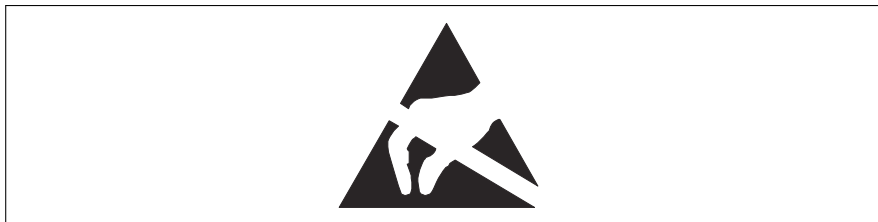

Figure 22: ESD label

i The ESD label can be different.

When you handle ESD modules, you must always observe the following points:

- ▶ Switch off the server and remove the power plugs from the power outlets before installing or removing ESD modules.
- ▶ The circuit boards and soldered parts of internal options are exposed and can be damaged by static electricity. To ensure reliable protection, you must wear an earthing band on your wrist when working with ESD modules and connect it to an unpainted, conducting metal part of the server.
- ▶ Any devices or tools that are used must be free of electrostatic charge.
- ▶ Wear a suitable grounding cable that connects you to the external chassis of the server.
- ▶ Always hold ESD modules at the edges or at the colored touch points.
- ▶ Do not touch any connectors or conduction paths on an ESD module.
- ▶ Place all the components on a pad which is free of electrostatic charge.

i For a detailed description of how to handle ESD modules, see the relevant European or international standards (EN 61340-5-1, ANSI/ESD S20.20).

4.2.8 Transporting the server



CAUTION

- ▶ Only transport the server in its original packaging or in packaging that protects it from impacts and jolts.

In Japan and APAC, transporting the server in its original packaging does not apply.

- ▶ Do not unpack the server until it is at its installation location.
- ▶ If you need to lift or transport the server, ask other people to help you.
- ▶ Never lift or carry the server by the handles or the Quick Release Levers (QRLs) on the front panel.

4.2.9 Installing the server in the rack



CAUTION

- ▶ For safety reasons, at least 2 people are required to install the server in the rack because of its weight and size.
(For Japan, see "安全上のご注意".)
- ▶ Never lift the server into the rack using the Quick Release Levers (QRLs) on the front panel.
- ▶ When connecting and disconnecting cables, observe the relevant instructions in the "Important Information" chapter of the technical manual for the corresponding rack. The technical manual is supplied with the corresponding rack.
- ▶ When installing the rack, ensure that the anti-tilt mechanism is correctly fitted.
- ▶ Do not extend more than one server out of the rack simultaneously even if the tilt protection is in place. If several servers are simultaneously extended from the rack, there is a risk that the rack could tip over. See the safety information of the rack and the warning label.
- ▶ If the server/rack is intended for permanent connection to the mains only an authorized specialist (electrician) is allowed to work. Please follow the regulation of each country.
- ▶ If the server is integrated into an installation that draws power from an industrial power supply network with an IEC309 type connector, the power supply's fuse protection must comply with the requirements for non-industrial power supply networks for the type A connector.

4.2.10 Other important information

- ▶ During cleaning, observe the instructions in the corresponding operating manual chapter "Operation" > "Cleaning the server".
- ▶ Keep all manuals close to the server. All documentation must be included if the equipment is passed on to a third party.

4.3 CE conformity

 The system complies with the requirements of European Regulations. Find the CE declaration on certificate portal: <https://sp.ts.fujitsu.com/sites/certificates/default.aspx>



CAUTION

This is a Class A product. In a domestic environment this product may cause RF interference.

- ▶ In this case the user may be required to take adequate measures.

To open the CE declaration applicable for your system, proceed as follows:

- ▶ Select the product class, e.g. "Industry Standard Servers".
- ▶ Select the subclass, e.g. "Rack server".
- ▶ Select your server, e.g. "PRIMERGY RX2540 M7".
- ▶ Select the document, e.g. "CE Cert PRIMERGY RX2540 M7".

4.4 ENERGY STAR



Products that have been certified compliant with ENERGY STAR and labelled are in full compliance with the specification at shipping. Note that energy consumption can be affected by software that is installed or any changes that are made to the hardware configuration or BIOS or energy options subsequently. In such cases, the properties guaranteed by ENERGY STAR can no longer be assured.

The "Fujitsu Software Infrastructure Manager V2.9.0 User's Guide" contains instructions for reading out measurement values, including those relating to current energy consumption and air temperatures. Either the Performance Monitor or the Task Manager can be used to read out CPU utilization levels.

Important information

Note

The following table shows that the processor dynamic voltage and frequency scaling, processor low-power idle state, and dynamic memory low-power state are enabled on shipment and the end user does not need to enable them.

Active State Power Management features	Enabled on shipment	End-user enabling required
Processor dynamic voltage and frequency scaling	Yes	No
Processor low-power idle state	Yes	No
Dynamic memory low-power state	Yes	No

4.5 FCC Class A Compliance Statement

If there is an FCC statement on the device, it applies to the products covered in this manual, unless otherwise specified herein. The statement for other products will appear in the accompanying documentation.

NOTE:

This equipment has been tested and found to comply with the limits for a "Class A" digital device, pursuant to Part 15 of the FCC rules and meets all requirements of the Canadian Interference-Causing Equipment Standard ICES-003 for digital apparatus. These limits are designed to provide reasonable protection against harmful interference in a residential installation. This equipment generates, uses and can radiate radio frequency energy and, if not installed and used in strict accordance with the instructions, may cause harmful interference to radio communications. However, there is no warranty that interference will not occur in a particular installation. If this equipment does cause harmful interference to radio or television reception, which can be determined by turning the equipment off and on, the user is encouraged to try to correct the interference by one or more of the following measures:

- ▶ Reorient or relocate the receiving antenna.
- ▶ Increase the separation between equipment and the receiver.

- ▶ Connect the equipment into an outlet on a circuit different from that to which the receiver is connected.
- ▶ Consult the dealer or an experienced radio/TV technician for help.

Fujitsu is not responsible for any radio or television interference caused by unauthorized modifications of this equipment or the substitution or attachment of connecting cables and equipment other than those specified by Fujitsu. The correction of interferences caused by such unauthorized modification, substitution or attachment will be the responsibility of the user.

The use of shielded I/O cables is required when connecting this equipment to any and all optional peripheral or host devices. Failure to do so may violate FCC and ICES rules.

4.6 Environmental protection

Environmentally-friendly product design and development

This product has been designed in accordance with the Fujitsu standard for "environmentally friendly product design and development". This means that key factors such as durability, selection and labeling of materials, emissions, packaging, ease of dismantling and recycling have been taken into account. This saves resources and thus reduces the harm done to the environment.

More information can be found at:

https://ts.fujitsu.com/products/standard_servers/index.html

For Japan:

<https://jp.fujitsu.com/platform/server/primergy/concept/>

Energy-saving information

Devices that do not need to be constantly switched on should be switched off until they are needed as well as during long breaks and after completion of work.

Packaging information

This packaging information does not apply in Japan and APAC. Do not throw away the packaging. You may need it later for transporting the server. If possible, the equipment should only be transported in its original packaging.

Important information

Information on handling consumables

Please dispose of printer consumables and batteries in accordance with the applicable national regulations.

In accordance with EU directives, batteries must not be disposed of with unsorted domestic waste. They can be returned free of charge to the manufacturer, dealer or an authorized agent for recycling or disposal.

All batteries containing pollutants are marked with a symbol (a crossed-out garbage can). They are also marked with the chemical symbol for the heavy metal that causes them to be categorized as containing pollutants:

Cd Cadmium

Hg Mercury

Pb Lead

Labels on plastic casing parts

Please avoid sticking your own labels on plastic parts wherever possible, since this makes it difficult to recycle them.

Returns, recycling and disposal

Please handle returns, recycling and disposal in accordance with local regulations.



The device must not be disposed of with domestic waste. This device is labeled in compliance with European directive 2012/19/EU on waste electrical and electronic equipment (WEEE).

This directive sets the framework for returning and recycling used equipment and is valid across the EU. When returning your used device, please use the return and collection systems available to you.

More information can be found at:

<https://ts.fujitsu.com/recycling>

Details regarding the return and recycling of devices and consumables within Europe can also be found in the "Returning used devices" manual, via your local Fujitsu branch, or at:

<https://ts.fujitsu.com/recycling>

5 Starting up

5.1 Safety notes



CAUTION

- ▶ Follow the safety instructions in ["Important information" on page 49](#).
- ▶ Do not expose the server to extreme environmental conditions (see ["Ambient conditions" on page 113](#)). Protect the server from dust, humidity and heat.
- ▶ Ensure that the server is acclimatized for the time indicated in [Table 4](#) before putting it into operation.

Temperature difference (°C)	Minimum acclimatization time (hours)
5	3
10	5
15	7
20	8
25	9
30	10

Table 4: Acclimatization time

In table [Acclimatization time](#), the temperature difference refers to the difference between the operating environment temperature and the temperature to which the server was exposed previously (outside, transport or storage temperature).

5.2 Installation steps, overview

- ▶ First of all, carefully read the safety instructions in ["Important information" on page 49](#) and following.
- ▶ Transport the server to the place where you want to set it up.

Starting up

- ▶ Unpack the system, check the contents of the package for visible transport damage and check whether the items delivered correspond to the details on the delivery note, see ["Unpacking the server" on page 65](#).
 - ▶ Ensure that you have all necessary manuals, see ["About availability of manuals" on page 15](#). If required, print out the PDF files.
 - ▶ Components that have been ordered additionally may be delivered loose with the server. For installing, see the original component documentation.
 - ▶ Install the server in the rack, see ["Installing the server in the rack" on page 66](#).
 - ▶ Connect the devices to the server. To do this, see ["Notes on connecting/disconnecting cables" on page 71](#) and ["Connecting devices to the server" on page 72](#).
 - ▶ Connect the server to the mains, see ["Connecting the power cord" on page 74](#).
 - ▶ If applicable, install the HDD/SSD modules, see ["Installing HDD/SSD modules" on page 91](#).
 - ▶ If applicable, install a second PSU, see ["Installing a second PSU" on page 95](#).
 - ▶ Familiarize yourself with the controls and indicators on the front and rear of the server, see ["Connectors, controls, and indicators" on page 32](#).
 - ▶ Configure the server and install the desired operating system and applications. The following options are available:
 - ▶ Installation with ServerView Installation Manager
 - Local configuration and installation, see ["Configuring the server with ServerView Installation Manager" on page 82](#).
 - Remote installation, see ["Configuring the server with ServerView Installation Manager" on page 82](#).
-  For more information on installing the server (remote or local), see the "ServerView Installation Manager" user guide at <https://support.ts.fujitsu.com>.
- ▶ Installation without ServerView Installation Manager
 - Local configuration and installation, see ["Configuring the server without ServerView Installation Manager" on page 84](#).

5.3 Unpacking the server



CAUTION

- ▶ Follow the safety instructions in ["Important information" on page 49](#).
 - ▶ The server must always be lifted or carried by at least two people. (For Japan, see " [安全上のご注意](#)".)
 - ▶ Do not unpack the server until it is at its installation location.
- ▶ Transport the server to the place where you want to set it up.
- ▶ Unpack all individual parts.
- Keep the original packaging in case you want to transport the server again (does not apply to Japan).
- ▶ Check the delivery for any damage during transport.
- ▶ Check whether the items delivered match the details on the delivery note. The product name and serial number of the product can be found on the ID card (see ["About availability of manuals" on page 15](#)).
- ▶ Notify your supplier immediately should you discover that the items delivered do not correspond to the delivery note.
- ▶ Remove all scratching protection foils from the front panel, HDD/SSD frames, Fujitsu and PRIMERGY logo, VGA dummy and ODD dummy in case they are still stuck to the server system.

5.4 Installing the server in the rack

5.4.1 Overview



CAUTION

- ▶ Please observe the safety information and notes on rack mounting in "[Important information](#)" on page 49 and "[Installing the server in the rack](#)" on page 65.
- ▶ At least two people are needed to install/remove the server in/from the rack. (For Japan, see "安全上のご注意".)
- ▶ Do not extend more than one unit out of the rack simultaneously even if the tilt protection is in place. If several units are simultaneously extended out of the rack, there is a risk that the rack could tip over.

Fujitsu rack systems

The rack systems from Fujitsu support the installation of PRIMERGY servers:

- PRIMECENTER rack
- PRIMECENTER M1 rack
- DataCenter rack
- 19-inch standard rack (for Japan)
- 19-inch slim rack (for Japan)



For information on mounting the server in the rack, see the "Mounting Instructions" provided with the Rack Mounting Kit. For more information, see the manual of your rack system.

For Japan, see also the "Rack system structure guide".



Online documentation for rack installation can be found at <https://support.ts.fujitsu.com> under **Product - Rack & Components**.

For Japan:

https://jp.fujitsu.com/platform/server/primergy/manual/peri_rack.html

To accommodate the ventilation concept and ensure proper ventilation, any unused areas in the rack must be sealed using dummy covers.

The power is supplied via the multiple socket outlets fitted in the rack (not valid for Japan).

The main features of Fujitsu rack systems are as follows:

- rail systems that can be mounted without tools
- support systems having a linear alignment feature to ensure that they can be adjusted to different rack depths

Asymmetrical PRIMECENTER rack and DataCenter rack provide an enhanced cable management in the lateral rack area.

3rd party racks



Installation in most current rack systems from other manufacturers (3rd party racks) is also supported. For details please contact your sales representative.

- ▶ Wire the server. Read the information in "[Connecting devices to the server](#)" on page 72 and "[Notes on connecting/disconnecting cables](#)" on page 71.
- ▶ Connect the system to the mains, see "[Connecting the power cord](#)" on page 74.

5.4.2 Installing the server in the rack



CAUTION

At least two people are needed to position the server on the rack rails.
(For Japan, see "安全上のご注意".)



For configurations below 32 kg:

At least two people are needed to lift the server into the rack cabinet.



For configurations below 55 kg:

At least three people are needed to lift the server into the rack cabinet.

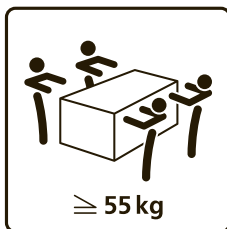

For configurations above 55 kg:

At least four people are needed to lift the server into the rack cabinet.

Additionally, a lifter is required in the following cases:

- The server weighs more than 50 kg.
- The server weighs more than 21 kg and is to be installed above the height of 25 U.

When using a lifter, this installation procedure needs to be carried out by maintenance personnel.

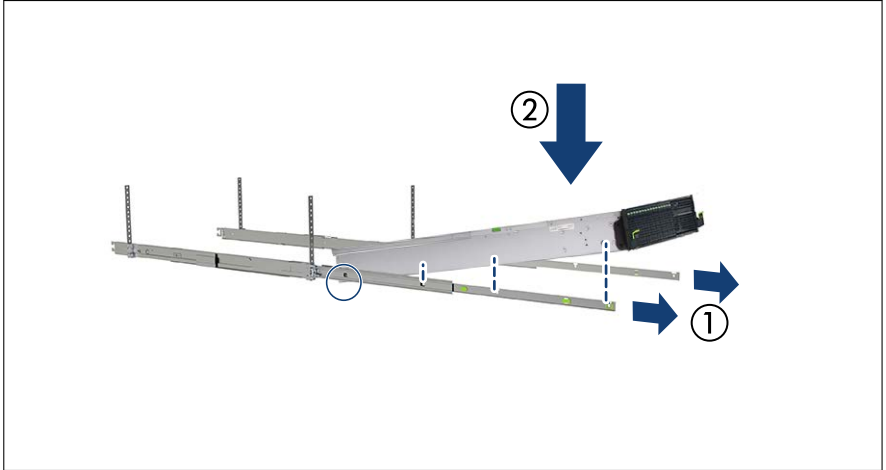

Figure 23: Installing the server in the rack rails

- ▶ Fully extend the rack rails until they lock in place (1).



The rack rails must click into place so that they can no longer be moved.

- ▶ At a slight angle, lower the server onto the rear mounting point on the rack rails (2).
- ▶ Ensure that all four rack mounting bolts are properly seated in the mounting points on the rack rails and that the locking bars engage.

5.4.3 Sliding the server into the rack

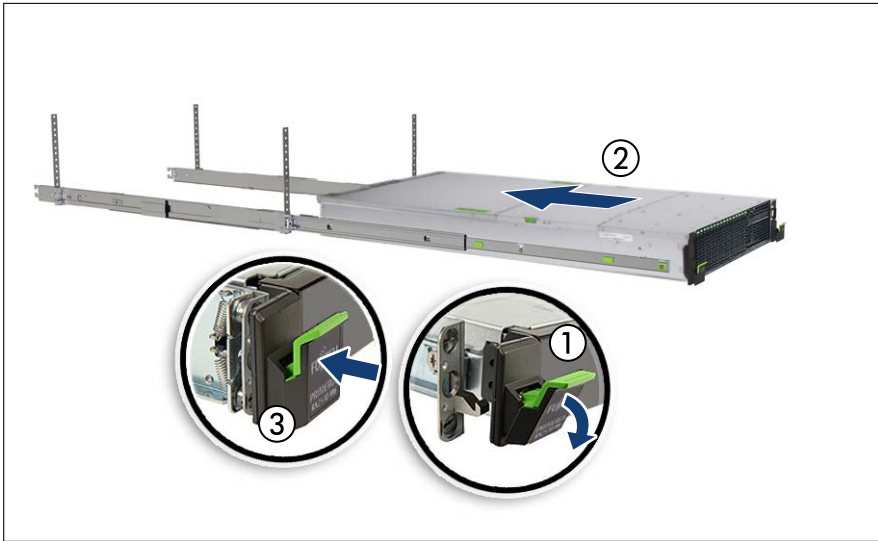

Figure 24: Sliding the server into the rack

- ▶ Release the locking mechanism of both rails (1).
- ▶ Push the server as far as it will go into the rack (2) until the two quick release levers engage (3).



CAUTION

- ▶ Be careful with your fingers. You can pinch them when the quick release levers change to the release position.
- ▶ Connect all cables except the power cord to the server rear.

5.5 Connecting cables

5.5.1 Notes on connecting/disconnecting cables



CAUTION

- ▶ Always read the documentation supplied with the device you wish to connect.
- ▶ Never connect, or disconnect cables during a thunderstorm.
- ▶ Never pull on a cable when disconnecting it. Always take hold of the cable by the plug.
- ▶ Follow the sequence described below to connect or disconnect external devices to or from the server.
- ▶ Ensure that you wait for 10 seconds or more after shutdown before turning the server on.

Connecting cables

- ▶ Switch off the server and equipment switches.
- ▶ Disconnect all power cords from the properly grounded power outlets.
- ▶ Disconnect the DC power cord with earth grounding conductor from the properly DC source and earth ground stud or end.
- ▶ Connect all cables to the server and peripherals.
- ▶ Connect all data communication cables into the utility sockets.
- ▶ Connect all power cords into the properly grounded power outlets.
- ▶ Connect the DC power cord with earth grounding conductor from the properly DC source and earth ground stud or end.

Disconnecting cables

- ▶ Switch off the server and equipment switches.
- ▶ Disconnect all power cords from the properly grounded power outlets.
- ▶ Disconnect the DC power cord with earth grounding conductor from the properly DC source and earth ground stud or end.

Starting up

- ▶ Disconnect all data communication cables from the utility sockets.
- ▶ Disconnect the relevant cables from the server and all the peripherals.



For connecting or disconnecting LAN cables, the server does not need to be powered off. To avoid loss of data teaming function has to be enabled.

Information for ensuring electromagnetic compatibility

All data and signal cables must have sufficient shielding. The use of cable type S/FTP Cat5 or higher is recommended.

Use of unshielded or badly shielded cables may lead to increased emission of interference and/or reduced fault-tolerance of the device.

5.5.2 Connecting devices to the server

The connectors for external devices are on the front and rear of the server, see ["Connectors, controls, and indicators" on page 32](#).



For a remote installation using the ServerView Installation Manger a LAN connection is necessary.



Some of the devices that can be connected may require special software, e.g. drivers (see the documentation for the connected device).

Connecting the keyboard, mouse and monitor

- ▶ Connect the keyboard and mouse to the USB connectors of the server.
- ▶ Connect the monitor to one of the two video connectors at the front or rear.

 The front video connector is designed for maintenance issues. If you connect a monitor to the video connector at the front, the video connector at the rear is deactivated. A monitor connected to the front must have at least the same resolution as the monitor connected to the rear. A console bypass is not possible via the video connector at the front.

 If a separate graphics card is installed in a slot, the graphic controller on the system board is automatically deactivated. The corresponding video connector can not be used. Connect the video cable of the monitor to the video connector of the graphics card.

- ▶ Connect the power cord of the monitor to a power outlet of the rack socket strip.

 The rated current for the monitor is indicated on the technical data label on the monitor or in the operating manual for the monitor.

5.5.3 Connecting the liquid cooling (LC) to the external cooling environment (special release)

 A LC configuration is provided on special release request only.

The quick connectors to connect the LC to the server system are on the server rear.

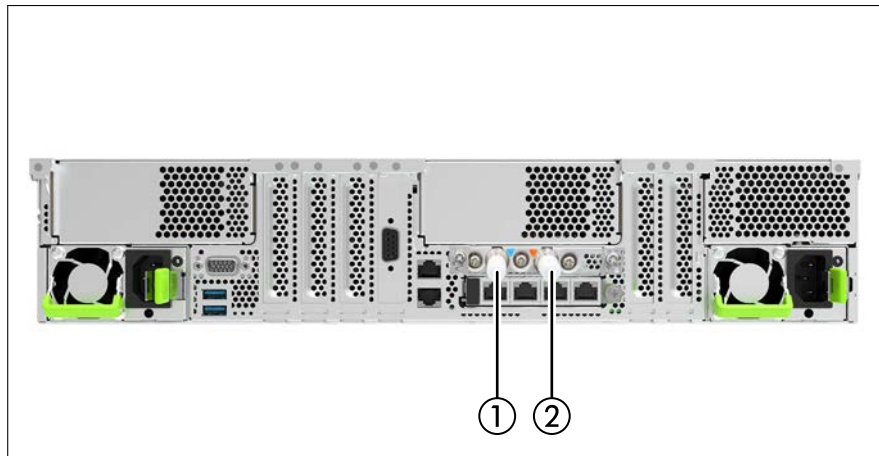

Figure 25: Quick connectors of the LC kit

- ▶ If applicable, remove both protective caps from the quick connectors.
- ▶ Connect the liquid inlet to the quick connector with the blue marking (1).
- ▶ Connect the liquid outlet to the quick connector with the red marking (2).

5.5.4 Connecting the power cord

5.5.4.1 Overview

In its basic configuration level the server has one PSU.

A second PSU can be added to ensure a redundant power supply. If one PSU is defective, the other then guarantees unimpaired operation. Each PSU can be replaced during operation (see the "PRIMERGY RX2540 M7 Server Upgrade and Maintenance Manual").



For more information, see the technical manual for the rack.

5.5.4.2 Connecting the power cord (AC PSU)



CAUTION

The AC PSU adjusts automatically to any mains voltage in the range from 100 V - 240 V (AC PSU Platinum) or 200 V - 240 V (AC PSU Titanium).

- ▶ You may only operate the server if its rated voltage range corresponds to the local mains voltage.
- ▶ Connect the power cord to the PSU.
- ▶ If applicable, connect the main plug to an power outlet of the rack socket strip.



To provide true phase redundancy, the second PSU should be connected to a different AC power source from the other PSU. If one AC power source should fail, the server will still continue to run.

- ▶ Ensure that the status indicator on the PSU is lit green, see ["Indicator on hot-plug PSU" on page 47](#).



It will take about 60 seconds until the server can be powered on.



You can secure the power cord with a cable clamp or a hook-and-loop tape to ensure that the power cord cannot be disconnected from the server by mistake.

Using a cable clamp

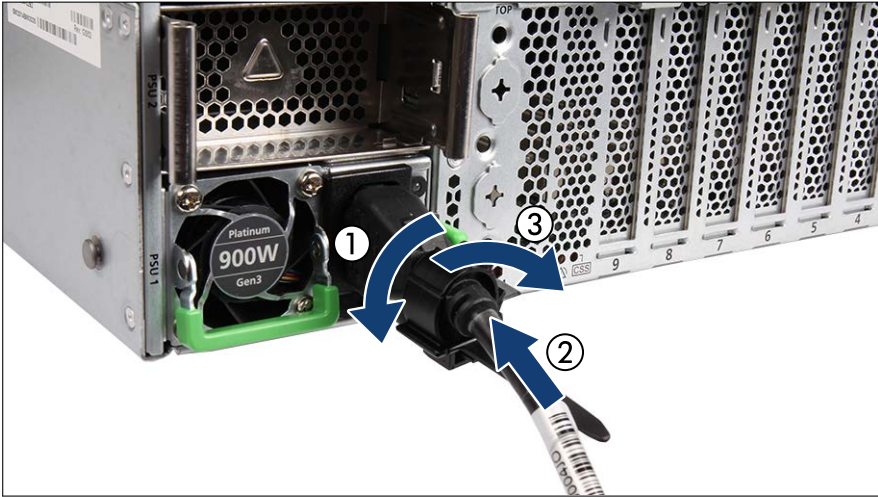

Figure 26: Locking the cable clamp of a PSU

- ▶ Pull the cable clamp up (1).
- ▶ Thread the power cord through the cable clamp (2).
- ▶ Press the cable clamp down until it engages to secure the cable (3).

Using a hook-and-loop tape



Figure 27: Example PSU with hook-and-loop tape

- 1 Hook-and-loop tape



Figure 28: Securing the power cord with the hook-and-loop tape (A)

- Unroll the hook-and-loop tape.



Figure 29: Securing the power cord with the hook-and-loop tape (B)

- ▶ Secure the mains connector of the power cord with the hook-and-loop tape.

5.5.4.3 Connecting the power cord (DC PSU)

Example DC PSU -48 V



CAUTION

The DC PSU adjusts automatically to any mains voltage in the range from -40.5 V - -57 V.

- ▶ You may only operate the server if its rated voltage range corresponds to the local mains voltage.

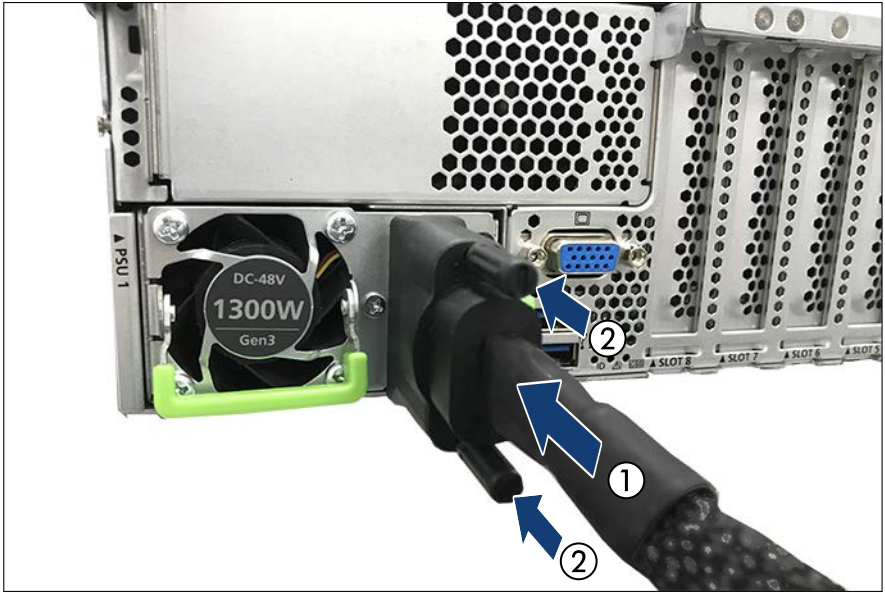

Figure 30: Connecting the server to the DC voltage - example DC PSU -48 V

- ▶ Connect the power cord to the PSU (1).
- ▶ Fasten the two studs (2).
- ▶ Ensure that the status indicator on the PSU is lit green, see "[Indicator on hot-plug PSU](#)" on page 47.
- ▶ If necessary, make a permanent connection to the distribution board.



CAUTION

If the server/rack is intended for permanent connection to the mains only an authorized specialist (electrician) is allowed to work.

- ▶ Please follow the regulation of each country.



It will take about 60 seconds until the server can be switched on.

Example HVDC PSU 380 V



CAUTION

The HVDC PSU adjusts automatically to any mains voltage in the range from 200 V – 380 V.

- ▶ You may only operate the server if its rated voltage range corresponds to the local mains voltage.

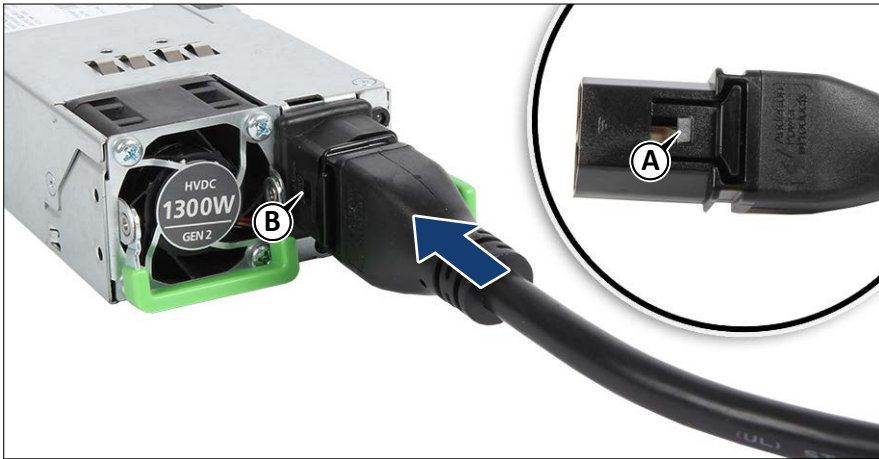

Figure 31: Connecting the server to the DC voltage - example HVDC PSU 380 V

- ▶ Push the power cord plug into the PSU connector until it clicks in. The nose of the power cord plug (A) engages in the recess of the PSU connector (B).
- ▶ Ensure that the status indicator on the PSU is lit green, see "[Indicator on hot-plug PSU](#)" on page 47.
- ▶ If necessary, make a permanent connection to the distribution board.



CAUTION

If the server/rack is intended for permanent connection to the mains only an authorized specialist (electrician) is allowed to work.

- ▶ Please follow the regulation of each country.



It will take about 60 seconds until the server can be switched on.

5.6 Switching on the server for the first time



CAUTION

- ▶ The On/Off button does not disconnect the server from the mains. To completely disconnect it from the mains, remove the power cords from the PSUs.
- ▶ Do not move, strike, or shake the server when it is switched on. This can damage the HDD/SSD in the server and cause data loss.
- ▶ Switch the server on when the temperature is in the specified temperature range. For more information on the operating environment, see "[Ambient conditions](#)" on page 113. When operating the server out of the specified temperature range, the server may operate improperly and data loss may occur. Furthermore, Fujitsu cannot be held responsible for any related damage, malfunction, or loss of data, etc.
- ▶ Ensure that you wait for 10 seconds or more after power off before switching on the server again.
- ▶ After connecting all power cords, wait at least 10 seconds before pressing the On/Off button.

Switching the server on

The AC connected indicator lights up white (standby mode) when the server is connected to the mains.



It will take about 60 seconds until the server can be switched on.

Starting up

For Japan, see "はじめにお読みください".

- ▶ Press the On/Off button.
- ▶ Configure your server and install the operating system, see "[Configuring the server with ServerView Installation Manager](#)" on page 82.

5.7 Installing the front cover with lock

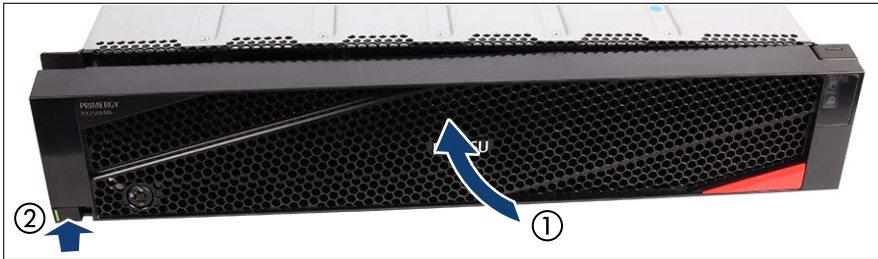

Figure 32: Installing the front cover with lock

- ▶ Attach the front cover in a slight angle to the front (1).
- ▶ Align the front cover to the front. The lock on the left side must be pushed in (2).



Figure 33: Turning the key

- ▶ Insert the key.
- ▶ Turn the key in locked position.

5.8 Configuring the server with ServerView Installation Manager



Ensure that the power saving functions are disabled in the **Configuration** menu of the BIOS setup during operation.

Advantages of the ServerView Installation Manager:

- Wizard-assisted configuration of your server hardware and disk arrays.
- Wizard-assisted installation of all leading server operating systems.
- Wizard-assisted creation of configuration files for unattended installation of several PRIMERGY servers with identical hardware configurations.
- Installation of drivers and additional software.

 The software that can be installed depends on the hardware configuration of your server. This configuration is detected automatically.

Configuring the controllers

 When using the ServerView Installation Manager you can configure the onboard controller either before or during installation.

- ▶ If applicable, configure the onboard SATA controller, see "[Notes on configuring controllers](#)" on page 84.
- ▶ If applicable, configure the SAS/SATA RAID controller with MegaRAID functionality, see "[Notes on configuring controllers](#)" on page 84.

Installing the operating system

 Descriptions of operating systems not covered in the RAID controller manual are provided in the corresponding readme files under:
<https://www.fujitsu.com/global/support/products/computing/servers/primergy/drivers/>

For Japan:

<https://www.fujitsu.com/jp/products/computing/servers/primergy/downloads/>

 For more information on installing the server, see the "ServerView Installation Manager" user guide at <https://support.ts.fujitsu.com> under **Product - Software - ServerView - Provisioning**.

- ▶ Open this manual.
- ▶ For the remote or local installation, follow the instruction in this manual and on the screen.

- ▶ Configure the settings for the general system behavior of the server using the Server Configuration Manager.

5.9 Configuring the server without ServerView Installation Manager

Configuring the onboard SATA controller

- ▶ If applicable, configure the onboard SATA controller, see "[Notes on configuring controllers](#)" on page 84.

Installing the operating system

- ▶ Insert the DVD for the operating system you want to install.
- ▶ Reboot the server.
- ▶ Follow the instructions on screen and in the manual for the operating system.

5.10 Notes on configuring controllers

5.10.1 General Notes



Ensure that the power saving functions are disabled in the **Power** menu of the BIOS setup during operation.



Descriptions of operating systems not covered in the controller manual are provided in the corresponding readme under:

<https://www.fujitsu.com/global/support/products/computing/servers/primergy/drivers/>

For Japan:

<https://www.fmworld.net/cgi-bin/drviasearch/drviaindex.cgi>

<https://www.fujitsu.com/jp/products/computing/servers/primergy/downloads/>

5.10.2 Notes on onboard SATA controllers

i The controller has its own configuration utility. For more information, see the "NVMe User Guide" at <https://support.ts.fujitsu.com/>.

i In the BIOS the onboard SATA controller can be configured as RAID (default) or non-RAID.

5.10.3 Notes on SAS/SATA RAID controllers

i A separate utility is available to the controller for MegaRAID configuration. For more information, see the "SAS Software User's Guide" available online at <https://support.ts.fujitsu.com/>.

More information on modular RAID controllers is provided in the "Modular RAID Controller Installation Guide" available online at <https://support.ts.fujitsu.com/>.

5.11 Note on operating system

Open the Windows operating system / Restoring the preinstalled environment

For the procedure to open the Windows operating system or to restore the preinstalled environment, see the manuals on the Fujitsu manual download site <https://www.fujitsu.com/jp/products/computing/servers/primergy/manual/> (for Japan only) or the attached manuals.

Linux operating system support

About the Fujitsu Support Pack for Linux (FJ-LSP)

The FJ-LSP can only be used from customers who have an contracted support as a tool to create an Fujitsu recommended Linux support environment.

The FJ-LSP can be downloaded from the Fujitsu SupportDesk subscriber site (SupportDesk web: <https://eservice.fujitsu.com/supportdesk-web/>).

Starting up

The FJ-LSP have to be used with the application wizard of the ServerView Installation Manager.

6 Operation

6.1 Safety notes



CAUTION

▶ Follow the safety instructions in ["Important information" on page 49](#).

6.2 Removing and installing the front cover with lock

Removing the front cover with lock



Figure 34: Turning the key

- ▶ Insert the key.
- ▶ Turn the key in open position.



Figure 35: Removing the front cover

- ▶ Push in the lock on the left side (1) and remove the front cover in a slight angle from the front (2).

Installing the front cover with lock

See ["Installing the front cover with lock" on page 82.](#)

6.3 Switching the server on and off



CAUTION

- ▶ The On/Off button does not disconnect the server from the mains. To completely disconnect it from the mains, remove the power cords from the PSUs.
- ▶ Do not move, strike, or shake the server when it is switched on. This can damage the HDD/SSD in the server and cause data loss.
- ▶ Switch the server on when the temperature is in the specified temperature range. For more information on the operating environment, see ["Ambient conditions" on page 113.](#) When operating the server out of the specified temperature range, the server may operate improperly and data loss may occur. Furthermore, Fujitsu cannot be held responsible for any related damage, malfunction, or loss of data, etc.
- ▶ Ensure that you wait for 10 seconds or more after power off before switching on the server again.
- ▶ After connecting all power cords, wait at least 10 seconds before pressing the On/Off button.

Switching the server on

The AC connected indicator lights up white (standby mode) when the server is connected to the mains.



It will take about 60 seconds until the server can be switched on.

- ▶ Press the On/Off button.

The server is switched on, performs a system test and boots the operating system.



In the case of configurations with a large memory size, the boot process may be prolonged.

Switching the server off

The power-on indicator lights up green.

- ▶ Shut down the operating system properly.

The server is switched off automatically and enters standby mode. The AC connected indicator lights up white.



CAUTION

When switching off the power

The operation of the power switch can be specified as "Do Nothing", "Stand by", "Hibernate", and "Shutdown" depending on the OS settings. The default is "Shutdown".

On this server, functions corresponding to "Stand by" and "Hibernate" are supported as BIOS and hardware functions. However, some drivers and software installed in the server do not support these functions. For this reason, functions corresponding to "Stand by" and "Hibernate" are unavailable on this server. When the operating mode is set to "Stand by" or "Hibernate", the system may operate improperly or HDD/SSD data may be corrupted.

For more information about operating mode settings, see the manual supplied with the OS.



If the operating system does not turn off the server automatically, press the On/Off button for at least four seconds and/or send a corresponding control signal for power button override.



CAUTION

There is a risk that data may be lost.

Other On/Off options

Besides the On/Off button, the server can be switched on and off in the following ways:

- **Timer-controlled turn-on/off**

Using the iRMC, you can configure that the server is turned on/off controlled by an internal timer.

- **Ring indicator**

The server is turned on by an internal or external modem.

- **Wake up On LAN (WOL)**

The server is turned on by a command via the LAN (Magic Packet™).

- **After power failure**

The server automatically reboots following a power failure (depending on the settings in the BIOS or in iRMC).

- **Power button override**

The system can be switched off (hard power off) by keeping the On/Off button (approximately 4 - 5 seconds).



CAUTION

There is a risk that data may be lost.

- **iRMC**

iRMC offers various options for switching the server on and off, e.g. via the **System power button** on the Global icons of the iRMC web interface.

6.4 Installing HDD/SSD modules

6.4.1 Installing 3.5-inch HDD modules

Removing a 3.5-inch HDD dummy module

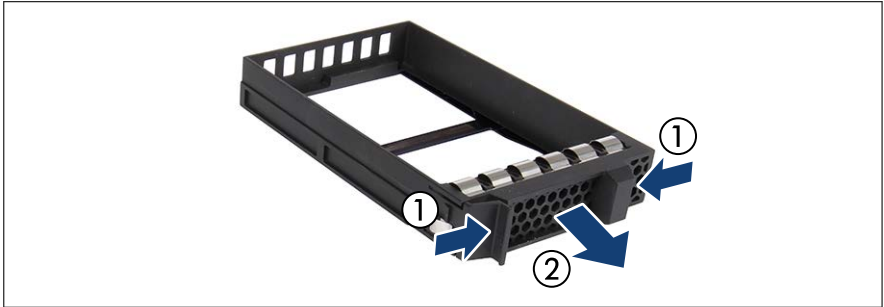

Figure 36: Removing the 3.5-inch dummy module

- ▶ Press both tabs together (1) and pull the dummy module out of its bay (2).



CAUTION

- ▶ Keep the dummy module for future use.
- ▶ Always replace dummy modules into unused HDD/SSD bays to comply with applicable EMC regulations and satisfy cooling requirements.

Installing a 3.5-inch HDD module



Figure 37: Opening the locking lever

- ▶ Pinch the green locking clip (1) and open the locking lever (2).



Figure 38: Installing the 3.5-inch HDD module

- ▶ Insert the HDD module into a drive bay and carefully push back as far as it will go (1).
- ▶ Close the locking lever to lock the HDD module in place (2).

- ▶ When using a RAID array, add the additional HDD to the RAID array.



Configuring the RAID array, refer to the documentation of the RAID controller, used in your configuration, see ["Documentation overview" on page 15](#).

6.4.2 Installing 2.5-inch HDD/SSD modules

Removing a 2.5-inch HDD/SSD dummy module

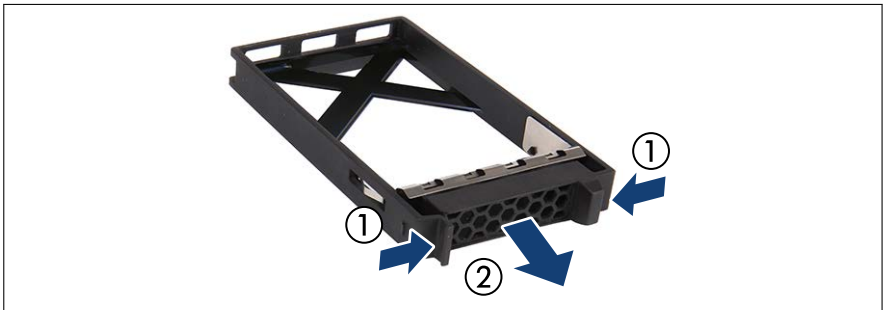

Figure 39: Removing a 2.5-inch HDD/SSD dummy module

- ▶ Press both tabs together (1) and pull the dummy module out of its bay (2).



CAUTION

- ▶ Keep the dummy module for future use.
- ▶ Always replace dummy modules into unused HDD/SSD bays to comply with applicable EMC regulations and satisfy cooling requirements.

Installing a 2.5-inch HDD/SSD module



Figure 40: Opening the locking lever

- ▶ Pinch the green locking clips (1) and open the locking lever (2).

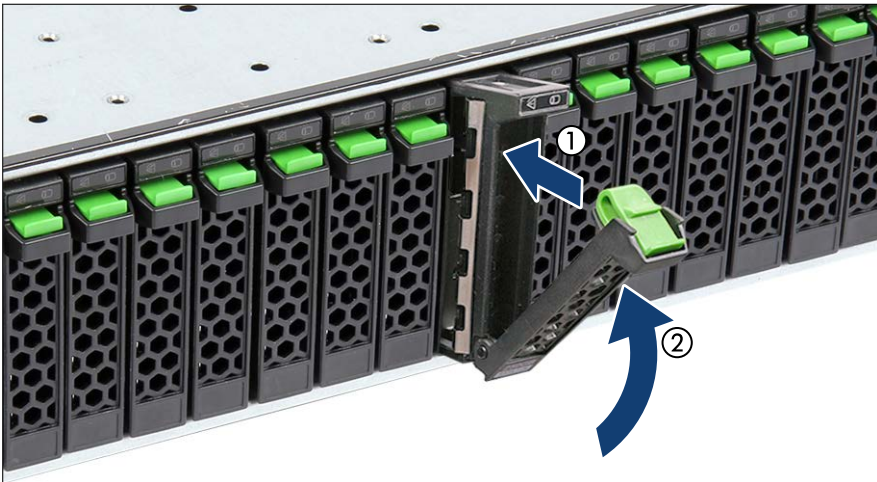

Figure 41: Installing the 2.5-inch HDD/SSD module

- ▶ Insert the HDD/SSD module into a drive bay and carefully push back as far as it will go (1).
- ▶ Close the locking lever to lock the HDD/SSD module in place (2).
- ▶ When using a RAID array, add the additional HDD/SSD to the RAID array.

i Configuring the RAID array, see the documentation of the RAID controller, used in your configuration, see "[List of documents](#)" on page 16.

6.5 Installing a second PSU

Removing the dummy cover

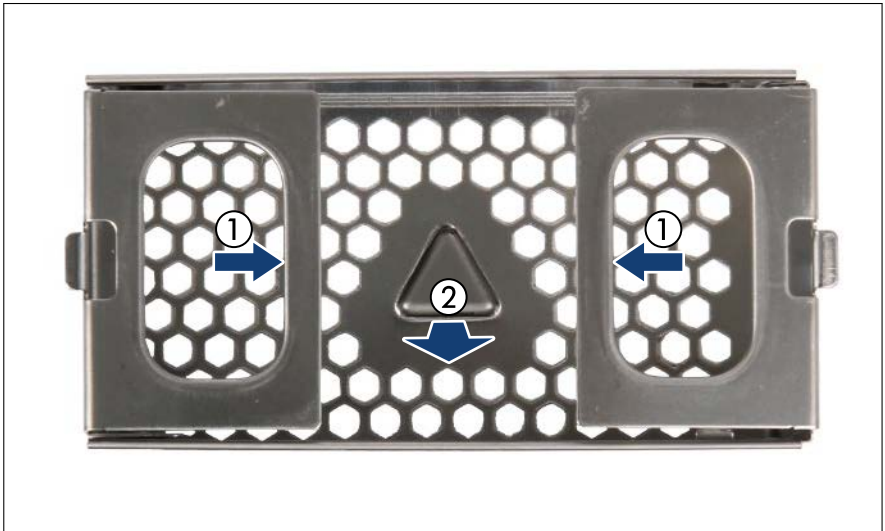

Figure 42: Removing the dummy cover

- ▶ Press in on both release latches (1) and pull out the dummy cover (2).



CAUTION

- ▶ Keep the dummy cover for future use.
- ▶ If you remove a PSU and do not immediately replace it with a new one, a dummy cover must be installed in the bay again to comply with applicable EMC regulations and satisfy cooling requirements.

Installing a hot-plug PSU

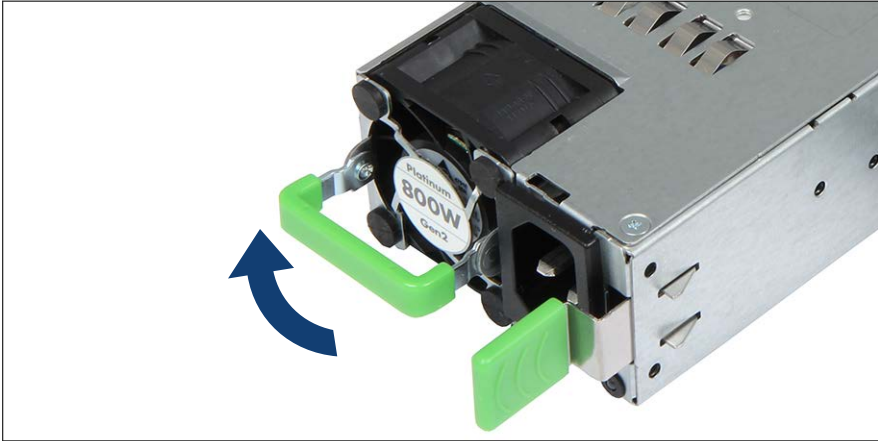

Figure 43: Folding up the handle

- ▶ Push the handle of the PSU halfway upward in the direction of the arrow.

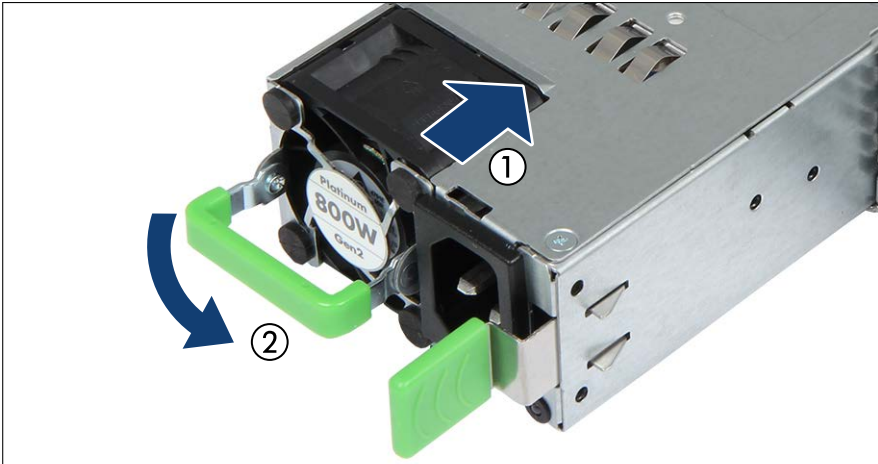

Figure 44: Installing the PSU

- ▶ Push the PSU into its bay (1) as far as it will go until the release latch snaps in place.
- ▶ Fold down the handle on the PSU (2).

- i** Ensure that the PSU engages correctly in the bay and is locked in position.



Figure 45: Installing the cable clamp

- ▶ Only for AC PSU with cable clamp: push the cable clamp into the corresponding hole until it clicks in.
- ▶ Connect the power cord to the PSU, see ["Connecting the power cord \(AC PSU\)" on page 75](#).

6.6 Cleaning the server



CAUTION

- ▶ Switch off the server and disconnect the power plugs from the properly grounded power outlets.
 - ▶ Do not clean any interior parts yourself; leave this job to a service technician.
 - ▶ Do not use any cleaning agents that contain abrasives or may corrode plastic.
 - ▶ Ensure that no liquid enters the system. Ensure that the ventilation areas of the server and the monitor are clear.
 - ▶ Do not use any cleaning sprays (including flammable types). It may cause a device failure or a fire.
-
- ▶ Clean the keyboard and the mouse with a disinfecting cloth.
 - ▶ Wipe the server and monitor casing with a dry cloth.
 - ▶ If particularly dirty, use a cloth that has been moistened in a mild domestic detergent and then carefully wrung out.

7 Troubleshooting and tips

7.1 General proceeding



CAUTION

- ▶ Follow the safety instructions in the "Safety Notes and Regulations" manual or "安全上のご注意" and in "Important information" on [page 49](#).

If a fault occurs, attempt to resolve it using the measures described:

- in this chapter,
- in the documentation for the connected devices,
- in the help systems of the software used.

If you fail to correct the problem, proceed as follows:

- ▶ Make a list of the steps performed and the circumstances that led to the fault. Also make a list of any error messages that were displayed.
- ▶ Switch off the server.
- ▶ Contact our customer service team.



The meaning of the error message is explained in the documentation for the relevant components and programs, available online at <https://support.ts.fujitsu.com/>.

7.2 iRMC cannot read detailed information from the NVIDIA T400 card

The **Graphics** page of the **System** menu of the iRMC's web interface displays the status of GPU cards. When the OS is running, the iRMC cannot read detailed information from the NVIDIA T400 card besides its temperature. In this case **N/A** is displayed for the related properties.

7.3 Power-on indicator remains unlit after you have switched on your device

Cause	Troubleshooting
Power cable incorrectly connected	<ul style="list-style-type: none">▶ Ensure that the power cable(s) is/are correctly connected to the server and the grounded power outlet(s).
Power supply overloaded	<ul style="list-style-type: none">▶ Disconnect the server power plug(s) from the grounded power outlet(s).▶ Wait a few minutes before you plug it/them into the grounded power outlet(s) again.▶ Switch on your server.

7.4 System does not boot after installing a new HDD

Cause	Troubleshooting
SAS configuration incorrect	<ul style="list-style-type: none">▶ Check the settings for the HDDs (SAS Device Configuration) and the additional settings in the SAS configuration menu.

7.5 Screen remains blank

Cause	Troubleshooting
Monitor is switched off	<ul style="list-style-type: none"> ▶ Switch on your monitor.
Screen has gone blank	<ul style="list-style-type: none"> ▶ Press any key on the keyboard. <li style="padding-left: 20px;">or ▶ Deactivate screen saver and enter the appropriate password.
Brightness control is set to dark	<ul style="list-style-type: none"> ▶ Set the brightness control on the monitor to light. <p>For more information, see the operating manual supplied with your monitor.</p>

7.6 No screen display or display drifts

Cause	Troubleshooting
Wrong horizontal frequency or resolution selected	<ul style="list-style-type: none"> ▶ Find out which horizontal frequency your monitor screen supports. You will find the horizontal frequency (also known as line frequency or horizontal deflection frequency) in the documentation for your monitor. ▶ See the documentation for your operating system or the software for the screen controller for more information of how to set the correct horizontal frequency for your monitor, and follow the procedure accordingly.

7.7 Server switches itself off

Cause	Troubleshooting
Server Management has detected an error	▶ Check the error list of System Event Log in the iRMC web interface, and attempt to eliminate the error.

7.8 No mouse pointer displayed on screen

Cause	Troubleshooting
Mouse driver not loaded	▶ Check whether the mouse driver is properly installed and is activated when the application program is started. Detailed information can be found in the user manuals for the mouse, the operating system and the application program.

7.9 No effect of keyboard or mouse

Cause	Troubleshooting
Typing the keyboard does not display any characters, or the mouse cursor does not move	▶ Check to see whether the keyboard and mouse are connected properly. If they are not connected or you replaced them yourself, then connect the cables to the server.

7.10 Time and/or date is incorrect

Cause	Troubleshooting
Time and date is incorrect	<ul style="list-style-type: none"> ▶ Set the correct time and date in the operating system. <li style="text-align: center;">or ▶ Set the correct time and date in the BIOS Information menu, using System Date and System Time respectively. <div style="border: 1px solid black; padding: 5px; margin-top: 10px;"> <p>i Note that the operating system may affect the system time. For example, the operating system time may deviate from the system time under Linux, and would overwrite the system time in the default setting on shutdown.</p> </div>
The lithium battery is discharged	<ul style="list-style-type: none"> ▶ If the date and time are still wrong after the server has been switched off and back on again, replace the lithium battery (see the "Fujitsu Server PRIMERGY RX2540 M7 Upgrade and Maintenance Manual") or contact our customer service team.

7.11 Temperature warning

A temperature warning is output to the hardware event log and OS event log, or ServerView issues a notification of a temperature warning such as by a popup message.

This warning is issued by ServerView when the ambient temperature exceeds the upper limit of the temperature boundaries. The upper limit is 35 °C for standard server and 40 °C or 45 °C with Advanced Thermal Design.

Cause	Troubleshooting
The ambient temperature exceeds the upper limit of the temperature boundaries	<ul style="list-style-type: none">▶ Although continued use within the temperature boundaries poses no problems within itself, reconsider the surrounding environment conditions if this log is output or if ServerView issues this notification.

7.12 Added drive reported as defective

Cause	Troubleshooting
RAID controller is not configured for this drive	<p>The drive was probably installed when the system was switched off.</p> <ul style="list-style-type: none">▶ Reconfigure the RAID controller for the drive using the corresponding utility. Information is provided in the documentation for the RAID controller. <p>or</p> <ul style="list-style-type: none">▶ Remove and reinstall the drive while the system is switched on. <p>If the HDD/SSD continues to be shown as defective, then replace it (see the "Fujitsu Server PRIMERGY RX2540 M7 Server Upgrade and Maintenance Manual").</p>

7.13 Expansion cards or onboard devices not recognized

When an expansion card is added, other expansion cards or onboard devices might not be recognized.

Cause	Troubleshooting
Expansion cards or onboard devices not recognized	<ul style="list-style-type: none"> ▶ Reinstall the drivers for the expansion cards or onboard devices that are not recognized.

Various HDD/SSD error messages may occur when the system is rebooted. These error messages are caused by modifications in the selected RAID configuration.

Cause	Troubleshooting
RAID controller configuration incorrect	<ul style="list-style-type: none"> ▶ Check and correct the settings for the drives using the RAID controller configuration program. <div style="border: 1px solid black; padding: 5px; margin-top: 10px;"> <p>i For more information, see the "Integrated RAID for SAS User's Guide" or the "Modular RAID Controller Installation Guide" available online at https://support.ts.fujitsu.com/.</p> </div>

7.14 ODD cannot read data

Cause	Troubleshooting
ODD cannot read data	<ul style="list-style-type: none"> ▶ Check to see whether the CD/DVD/BD is inserted properly. If the CD/DVD/BD is not inserted, correctly insert the disk so that the label is facing up. ▶ Check to see whether the CD/DVD/BD is not dirty. If the CD/DVD/BD is dirty, wipe it in a radial way with a soft, dry cloth. ▶ Check to see whether the CD/DVD/BD is not scratched or bent. If scratched or damaged, replace the CD/DVD/BD.

8 Technical data

8.1 Data Sheets

The specifications for this server are liable to be updated without any notice. Please be forewarned.



The data sheets for this server contain more technical data. The data sheets are available online at:

<https://www.fujitsu.com/fts/products/computing/servers/primergy>

For more information, see the **Documents** tab under e.g. **Rack Servers**.

For Japan:

<https://www.fujitsu.com/jp/products/computing/servers/primergy>

8.2 System board

System board type	D3983
Chipset	Intel®C741 Chipset / Emmitsburg PCH

8.3 Processor (CPU)

CPU quantity and type	1 or 2 Intel® Xeon® CPUs (Platinum, Gold, Silver, Bronze)
-----------------------	---

8.4 Memory modules configuration

Memory slots	32 (16 DIMMs per CPU, 8 channels with 2 slots per channel)
Memory type	RDIMM (DDR5)
Memory capacity (min. - max.)	Up to 8TB/CPU using DDR5 DIMMs (256 GB DDR5 x32) Up to 16TB/2CPUs using DDR5 DIMMs (256 GB DDR5 x32)
Memory protection	ECC; SDDC; ADDDC Sparing; Channel mirroring within a socket; HW memory scrubbing Not supports Rank level sparing
Memory notes	RDIMM: 4800 MHz memory modules with 16, 32, 64, 128, or 256 GB

8.5 Interfaces

USB	Rear: 2x USB 3.0 Front: 2x USB 3.0 Internal: 1x USB 3.0
Graphics (15-pin)	2 x VGA (1x front optional)
Serial 1 (9-pin)	1x serial RS-232C (optional), usable for iRMC or system or shared

<p>LAN/Ethernet</p>	<p>1 x 1 Gbit/s Ethernet (Shared LAN) (RJ45).</p> <p>OCP option:</p> <ul style="list-style-type: none"> – Intel 1GbE BASE-T for OCPv3 internal lock – Broadcom 1GbE BASE-T for OCPv3 internal lock – Intel 10GbE BASE-T for OCPv3 internal lock – Broadcom 10GbE BASE-T for OCPv3 internal lock – Intel 10GbE for OCPv3 internal lock – Broadcom 10GbE for OCPv3 internal lock – Intel 25GbE for OCPv3 internal lock – Mellanox 25GbE for OCPv3 internal lock – Intel 100GbE for OCPv3 internal lock – Mellanox 100GbE for OCPv3 internal lock <p>PCIe Adapter:</p> <ul style="list-style-type: none"> – Intel 1GbE BEASE-T for PCIe – Broadcom 1GbE BEASE-T for PCIe – Intel 10GbE BEASE-T for PCIe – Broadcom 10GbE BEASE-T for PCIe – Intel 10GbE for PCIe – Broadcom 10GbE for PCIe – Intel 25GbE for PCIe – Intel 100GbE for PCIe – Mellanox 100GbE for PCIe
<p>Management LAN (RJ45)</p>	<p>1x dedicated management LAN port for iRMC (10/100/1000 Mbit/s). Management LAN traffic can be switched to shared onboard converged network adapter.</p>

8.6 Onboard or integrated controllers

RAID controllers	<p>PRAID EP520i (based on LSI SAS3508) SAS/SATA/PCIe HDD/SSD up to 12 Gbit/s SAS, 6 Gbit/s SATA, 8 Gbit/s PCIe, 8 ports internal RAID level: 0, 1, 1E, 10, 5, 50, 6, 60 2 GB cache, optional FBU</p> <p>PRAID EP6xx (based on Broadcom SAS3916) SAS/SATA/PCIe HDD/SSD up to x16 ports with 12Gb/s SAS, 6Gbp/s SATA 16GT/s NVMe 16 ports internal / 8 ports external RAID level: 0, 1, 1E, 10, 5, 50, 6, 60 8 GB cache, optional FBU</p>
SATA controller	<p>1x SATA controller integrated on the system board; up to eight SATA HDDs/SSDs can be connected to the controller.</p> <p>1x single SATA connector for ODD 1x SlimSAS for 2x M.2 slots (Key M)</p>
LAN controller	<p>1x 1G on board LAN</p> <p>PXE-Boot via LAN from PXE server, iSCSI boot (also diskless).</p>
Remote Management Controller	<p>Integrated Remote Management Controller with integrated video engine (iRMC S6), 512 MB DDR5 DRAM, IPMI 2.0 compatible.</p>
Trusted Platform Module (TPM)	<p>Infineon / separate module; TCG V2.0 compliant, SPI support (option)</p>

8.7 Slots

Slot 1/2: PCIe Gen5 x16 (mechanical x16)	Low profile (LP)
Slot 3/4: PCIe Gen5 x8 (mechanical x8)	Full height/length (FHFL)

Slot 5/6: PCIe Gen5 x8 (mechanical x16)	Low profile (LP)
Slot 7/8: PCIe Gen5 x16 (mechanical x16)	Low profile (LP)
Slot 9/10: PCIe Gen5 x8 (mechanical x8)	Full height/length (FHFL)
Slot 3/9: PCIe Gen5 x16 (mechanical x16)	Full height/length (FHFL) GPGPU card support
Slot notes	CPU1 supports slot 1-4 CPU2 supports slot 5-10 Slot 3/4 and Slot 9/10 or Slot 3 and Slot 9 are only available if a riser card is installed.
Slot notes	One Internal Riser PCIe Gen4 x8 slot may be occupied with a Modular RAID controller if configured.
Slot notes	PCIe slot 1/5/6 Gen5 slot may be occupied with a Modular RAID controller if configured.
Liquid cooling slot	Liquid cooling module

8.8 Drive bays

<p>Hot plug 3.5-inch HDD bay configuration</p> <ul style="list-style-type: none"> • Upgradeable to 12 Drives <p>Hot plug 2.5-inch HDD/SSD/PCIe SSD configuration</p> <ul style="list-style-type: none"> • Upgradeable to 24 Drives+ 4/6 Rear Drives (optional) 	<p>Front:</p> <ul style="list-style-type: none"> – up to 12x 3.5-inch HDD – up to 24x 2.5-inch HDD/SSD <p>Rear:</p> <ul style="list-style-type: none"> – up to 4/6x 2.5-inch SAS/SATA
<p>Accessible drive bay (not on 24x 2.5-inch HDD/SSDs, NVMe Mix, 24x2.5-inch NVMe SSDs only and 12x 3.5-inch HDDs)</p>	<p>1 x 5.25/0.5-inch for ODD drive 1x 5.25-inch RDX drive 1x 5.25-inch LTO drive</p>

8.9 Dimension/Weight

<p>Rack (W x D x H)</p>	<p>435 mm [482.5 mm (with both ears)] × 811.5 mm [873.1 mm (COP to DC PSU latch)] × 86.9 mm</p>
<p>Height unit rack</p>	<p>2 HU</p>
<p>Installation depth in rack</p>	<p>843.6 mm</p>
<p>Weight</p>	<p>Max. 34.94 kg [39.08 kg (with RMK)]</p>
<p>Weight notes</p>	<p>Weight may vary depending on actual configuration.</p>

Rack mounting kit	RAIL KIT-BALL BEARING TYPE (standard type; P/N: CA05950-2169): 4.5 kg RAIL KIT-FRICTION TYPE (low cost type; P/N: CA05950-2170): 3.8 kg
-------------------	--

8.10 Ventilation clearance

There must be a clearance of at least 200 mm in front of and behind the server to ensure adequate ventilation of the subsystem.

8.11 Ambient conditions

All temperature ratings shown are valid for sea level. An altitude derating of 1 °C per 300 m to 3050 m is applicable.

Environment class 3K2	EN 60721 / IEC 721 Part 3-3
Environment class 2K2	EN 60721 / IEC 721 Part 3-2
Operation temperature (3K2)	10 °C ... 35 °C 5 °C ... 40 °C (with ATD 40 °C) 5 °C ... 45 °C (with ATD 45 °C)
Transport temperature (2K2)	-25 °C ... 60 °C
Humidity	8% ... 85%, maximum dew point 21 °C (non condensing)
Condensation during operation must be avoided!	

Technical data



Fujitsu PRIMERGY Servers are designed for the usage with operating temperatures of up to 35 °C. There could be configurations that are not able to work within this normal operation class.

Please refer to Datasheet and Fujitsu WebArchitect to obtain detailed information on the corresponding configurations:

www.fujitsu.com/configurator/public

For Japan:

<https://www.fujitsu.com/jp/products/computing/servers/primergy/>

8.12 Noise level

The acoustic noise values are depending on the system configuration.

	typical configuration 2x PSU / 2x CPU	max. configuration 2x PSU / 2x CPU
Sound power level $L_{WA,d}$ (ISO 9296)	< 5.3 B (standby) < 5.6 B (operation)	< 7.3 B (standby) < 7.5 B (operation)
Sound pressure level at adjacent workstation L_{pAm} (ISO 9296)	< 39.3 dB(A) (standby) < 41.9 dB(A) (operation)	< 55.2 dB(A) (standby) < 55.6 dB(A) (operation)

8.13 Electrical values of the AC PSUs

Electrical data: 500 W Titanium

(P/N: S26113-E651-V50-1 / DPS-500AB-65A)

Rated voltage range	100 V - 240 V
Frequency	50 Hz - 60 Hz
Max. rated current	200 V: 3.0 A 100 V: 6.1 A
DC output	500 W max.

Active power max. (AC input)	613 W
Apparent power max.	200 V : 560 VA 100 V : 580 VA
Heat dissipation	2206.8 KJ/h (2091.6 BTU/h)
Main power fuse	10 A
Protection class	I

Electrical data: 900 W Platinum
(P/N: S26113-E628-V50-1 / DSP-900AB-3A)

Rated voltage range	100 V - 127 V / 200 V - 240 V
Frequency	47 Hz - 63 Hz
Max. rated current	11 A - 5.7 A
DC output	900 W max.
Active power max. (AC input)	1088 W
Apparent power max.	230 V : 1035 VA 100 V : 1100 VA
Heat dissipation	3916.8 KJ/h (3712.4 BTU/h)
Main power fuse	16 A
Protection class	I

Electrical data: 900 W Platinum
(P/N: S26113-E628-V60-1 / PS-2901-5J)

Rated voltage range	100 V - 240 V
Frequency	50 Hz - 60 Hz
Max. rated current	11 A - 4.5 A
DC output	900 W max.

Technical data

Active power max. (AC input)	1088 W
Apparent power max.	230 V : 1035 VA 100 V : 1100 VA
Heat dissipation	3916.8 KJ/h (3712.4 BTU/h)
Main power fuse	16 A
Protection class	I

Electrical data: 900 W Titanium (P/N: S26113-E629-V50-1 / DPS-900AB-2A)

Rated voltage range	200 V - 240 V
Frequency	47 Hz - 63 Hz
Max. rated current	5.7 A
DC output	900 W max.
Active power max. (AC input)	1024 W
Apparent power max.	230 V : 1035 VA
Heat dissipation	3686.4 KJ/h (3494 BTU/h)
Main power fuse	16 A
Protection class	I

Electrical data: 1600 W Platinum (P/N: S26113-E630-V50-1 / DPS-1600AB-36A)

Rated voltage range	100 V - 127 V / 200 V - 240 V
Frequency	47 Hz - 63 Hz
Max. rated current	12 A - 10 A
DC output	100 V - 127 V (1000 W max.) 200 V - 240 V (1600 W max.)

Active power max. (AC input)	1848 W
Apparent power max.	230 V : 1868 VA 100 V : 1252 VA
Heat dissipation	6652.8 KJ/h (6305.6 BTU/h)
Main power fuse	20 A
Protection class	I

**Electrical data: 1600 W Titanium
(P/N: S26113-E652-V60-1 / PS-2162-17J)**

Rated voltage range	100 V - 127 V 200 V - 240 V
Frequency	50 Hz - 60 Hz
Max. rated current	200 V: 10 A 100 V: 12 A
DC output	200 V: 1600 W max. 100 V: 1000 W max.
Active power max. (AC input)	200 V: 1758 W 100 V: 1159 W
Apparent power max.	200 V : 1790 VA 100 V : 1180 VA
Heat dissipation	5760 KJ/h (5459.4 BTU/h)
Main power fuse	20 A
Protection class	I

**Electrical data: 2200 W Platinum
(P/N: S26113-E646-V50-1 / DPS-2200AB-14A)**

Rated voltage range	100 V - 127 V / 200 V - 220 V / 220 V - 240 V
Frequency	50 Hz - 60 Hz

Technical data

Max. rated current	12.5 A / 11.3 A / 14 A
DC output	100 V - 127 V (1000 W max.) 200 V - 220 V (2000 W max.) 220 V - 240 V (2200 W max.)
Active power max. (AC input)	2544 W
Apparent power max.	230 V : 2570 VA 100 V : 1252 VA
Heat dissipation	9158.4 KJ/h (8680.4 BTU/h)
Main power fuse	16 A
Protection class	I

Electrical data: 2400 W Titanium (P/N: S26113-E653-V60-1 / PS-2242-7J)

Rated voltage range	100 V - 127 V 200 V - 240 V
Frequency	50 Hz - 60 Hz
Max. rated current	200 V: 15 A 100 V: 12 A
DC output	200 V: 2400 W max. 100 V: 1000 W max.
Active power max. (AC input)	200 V: 2608.6 W 100 V: 1146 W
Apparent power max.	200 V : 2635 VA 100 V : 1164 VA
Heat dissipation	8640 KJ/h (8189.1 BTU/h)
Main power fuse	20 A
Protection class	I

8.14 Electrical values of the DC PSU -48 V

Electrical data: 1300 W -48 V DC
(P/N: S26113-E647-V50-1 / DPS-1300AB-28 A)

Rated voltage range	-48 V - -60 V
Frequency	DC
Max. rated current (DC input)	37 A max.
Active power max. (DC input)	1560 W
Apparent power max.	N/A
DC output	1300 W max.
Heat dissipation	5616 KJ/h (5322.9 BTU/h)
Main power fuse	16 A
Protection class	I

8.15 Electrical values of the HVDC PSU 380 V

Electrical data: 1600 W HVDC PSU 380 V
(P/N: S26113-E631-V60-1 / DD-2162J)

Rated voltage range	200 V - 380 V
Frequency	DC
Max. rated current (DC input)	10 A
Active power max. (DC input)	1800 W
Apparent power max.	N/A
DC output	1600 W max.
Heat dissipation	6480 KJ/h (6141.8 BTU/h)

Technical data

Main power fuse	16 A
Protection class	I

8.16 Electrical values of the system

Electrical data: System

500 W Platinum	
Rated voltage range	100 V - 240 V
Frequency	47 Hz - 63 Hz
Max. rated current	6.5 A - 2.9 A (x2)



Recommended max. drives (HDD/SSD/NVMe), it depends on the configuration:

- Up to 10x 2.5-inch HDD/SSD
- Up to 8x 3.5-inch HDD
- Up to 10x NVMe

900 W Platinum	
Rated voltage range	100 V - 127 V / 200 V - 240 V
Frequency	47 Hz - 63 Hz
Max. rated current	11 A / 4.5 A (x2)



Recommended max. drives (HDD/SSD/NVMe), it depends on the configuration:

- Up to 20x 2.5-inch HDD/SSD
- Up to 12x 3.5-inch HDD
- Up to 20x NVMe



100 V - 127 V (not for India).
220 V - 240 V (for China only).

900 W Titanium	
Rated voltage range	200 V - 240 V
Frequency	47 Hz - 63 Hz
Max. rated current	5.7 A (x2)

i Recommended max. drives (HDD/SSD/NVMe), it depends on the configuration:

- Up to 20x 2.5-inch HDD/SSD
- Up to 12x 3.5-inch HDD
- Up to 20x NVMe

1600 W Platinum	
Rated voltage range	100 V - 127 V / 200 V - 240 V
Frequency	50 Hz - 60 Hz
Max. rated current	12 A / 10 A (x2)

i 100 V - 127 V (not for India).
220 V - 240 V (for China only).

2200 W Platinum	
Rated voltage range	100 V - 127 V / 200 V - 240 V
Frequency	50 Hz - 60 Hz
Max. rated current	12.5 A / 11.3 A (x2)

1600 W HVDC PSU 380 V	
Rated voltage range	200 V - 380 V
Frequency	DC
Max. rated current	10 A (x2)

Technical data

1300 W DC -48 V PSU	
Rated voltage range	-48 V - -60 V
Frequency	DC
Max. rated current	32 A (x2)

8.17 Compliance with standards

Global	CB-Scheme (ITE) CISPR 32 CISPR 35 RoHS (Substance limitations in accordance with global RoHS regulations) WEEE (Waste electrical and electronic equipment)
Europe	EMC Directive 2014/30/EU LVD Directive 2014/35/EU RoHS Directive 2011/65/EU with all amendments (incl. (EU) 2015/863) Ecodesign Directive 2009/125/EC for energy-related products NSF/ANSI 426 Environmental Leadership and Corporate Social Responsibility Assessment of Servers
UKCA	UKCA
Germany	GS
USA / Canada	Safety NRTL FCC 47CFR part 15 Class A / ICES-003
Japan	VCCI Class A / JEITA / JEL (Japan Energy)
Australia / New Zealand	AUS/NZ (RCM class A EMC)
Taiwan	BSMI

China	CCC
Korea	KC-Mark EMC class A

**CAUTION**

This device meets the requirements of Class A CISPR 32/35. This device can cause radio interference in residential areas.

9 Warranty and service

Warranty

The warranty regulations can be found online at:

<https://support.ts.fujitsu.com/>

For Japan:

<https://www.fujitsu.com/jp/products/computing/servers/primergy/support/>

For the warranty regulations select "製品保証ご案内(無償修理期間)"

Service

Telephone numbers of the local service partner can be found online at:

<https://support.ts.fujitsu.com/IndexContact.asp?OpenTab=serviceesk>